

AP Physics C – Practice Workbook – Book 2

Electricity and Magnetism

C

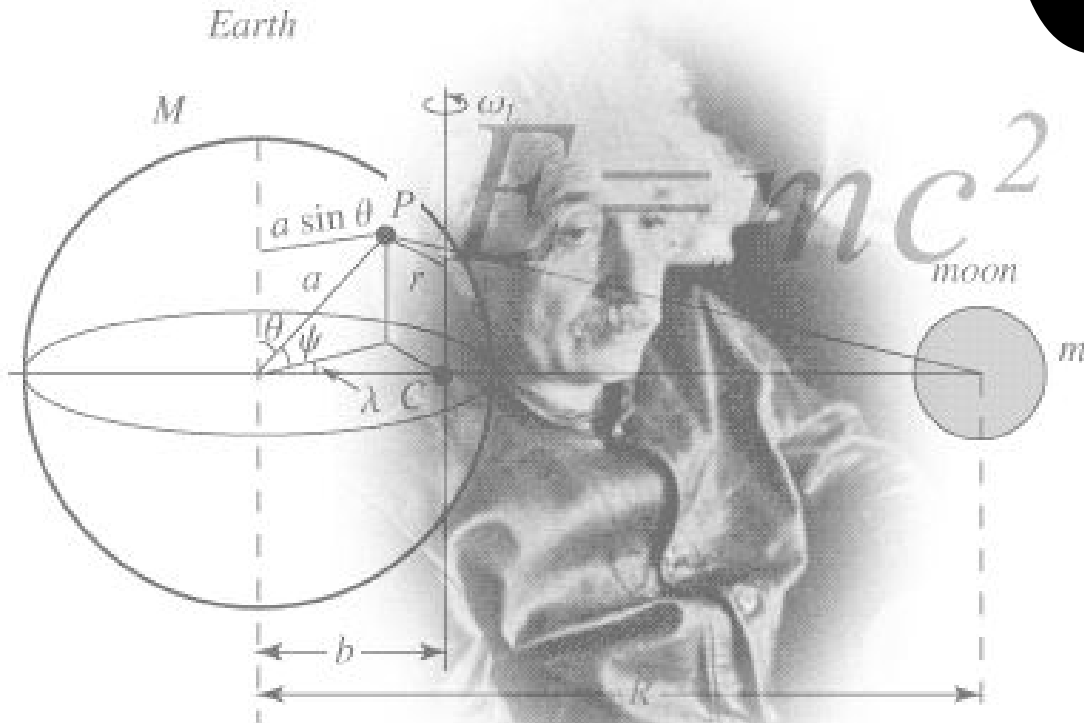

The following © is applicable to this entire document – copies for student distribution for exam preparation explicitly allowed.

1) Copyright © 1973-2012 College Entrance Examination Board. All rights reserved. College Board, Advanced Placement Program, AP, AP Central, AP Vertical Teams, APCD, Pacesetter, Pre-AP, SAT, Student Search Service, and the acorn logo are registered trademarks of the College Entrance Examination Board. PSAT/NMSQT is a registered trademark of the College Entrance Examination Board and National Merit Scholarship Corporation. Educational Testing Service and ETS are registered trademarks of Educational Testing Service. Other products and services may be trademarks of their respective owners.

2012-2013

Table of Contents

Table of Information and Equation Tables	3
--	---

Chapter 8 Electrostatics

Electrostatics Multiple Choice	
Section A – Coulomb’s Law and Coulomb’s Law Methods	11
Section B – Gauss’s Law	16
Section C – Electric Potential And Energy	19
Section D – Capacitance	31
Electrostatics Free Response	
Section A – Coulomb’s Law and Coulomb’s Law Methods	35
Section B – Gauss’s Law	41
Section C – Electric Potential And Energy	54
Section D – Capacitance	62
Answers to Electrostatics Questions	67

Chapter 9 Circuits

Circuits Multiple Choice	91
Circuits Free Response	99
Answers to Circuits Questions	113

Chapter 10 Magnetism and Induction

Magnetism and Induction Multiple Choice	
Section A – Magnetostatics	125
Section B – Biot Savart and Ampere’s Law	130
Section C – Induction and Inductance	134
Magnetism and Induction Free Response	
Section A – Magnetostatics	141
Section B – Biot Savart and Ampere’s Law	147
Section C – Induction and Inductance	155
Answers to Magnetism and Induction Questions	187

This book is a compilation of all the problems published by College Board in AP Physics C organized by topic.

The problems vary in level of difficulty and type and this book represents an invaluable resource for practice and review and should be used... often. Whether you are struggling or confident in a topic, you should be doing these problems as a reinforcement of ideas and concepts on a scale that could never be covered in the class time allotted.

The answers as presented are not the only method to solving many of these problems and physics teachers may present slightly different methods and/or different symbols and variables in each topic, but the underlying physics concepts are the same and we ask you read the solutions with an open mind and use these differences to expand your problem solving skills.

Finally, we *are* fallible and if you find any typographical errors, formatting errors or anything that strikes you as unclear or unreadable, please let us know so we can make the necessary announcements and corrections.



Table of Information and Equation Tables for AP Physics Exams

The accompanying Table of Information and Equation Tables will be provided to students when they take the AP Physics Exams. Therefore, students may NOT bring their own copies of these tables to the exam room, although they may use them throughout the year in their classes in order to become familiar with their content. **Check the Physics course home pages on AP Central for the latest versions of these tables (apcentral.collegeboard.com).**

Table of Information

For both the Physics B and Physics C Exams, the Table of Information is printed near the front cover of the multiple-choice section and on the green insert provided with the free-response section. The tables are identical for both exams except for one convention as noted.

Equation Tables

For both the Physics B and Physics C Exams, the equation tables for each exam are printed only on the green insert provided with the free-response section. The equation tables may be used by students when taking the free-response sections of both exams but NOT when taking the multiple-choice sections.

The equations in the tables express the relationships that are encountered most frequently in AP Physics courses and exams. However, the tables do not include all equations that might possibly be used. For example, they do not include many equations that can be derived by combining other equations in the tables. Nor do they include equations that are simply special cases of any that are in the tables. Students are responsible for understanding the physical principles that underlie each equation and for knowing the conditions for which each equation is applicable.

The equation tables are grouped in sections according to the major content category in which they appear. Within each section, the symbols used for the variables in that section are defined. However, in some cases the same symbol is used to represent different quantities in different tables. It should be noted that there is no uniform convention among textbooks for the symbols used in writing equations. The equation tables follow many common conventions, but in some cases consistency was sacrificed for the sake of clarity.

Some explanations about notation used in the equation tables:

1. The symbols used for physical constants are the same as those in the Table of Information and are defined in the Table of Information rather than in the right-hand columns of the tables.
2. Symbols in bold face represent vector quantities.
3. Subscripts on symbols in the equations are used to represent special cases of the variables defined in the right-hand columns.
4. The symbol Δ before a variable in an equation specifically indicates a change in the variable (i.e., final value minus initial value).
5. Several different symbols (e.g., d , r , s , h , ℓ) are used for linear dimensions such as length. The particular symbol used in an equation is one that is commonly used for that equation in textbooks.

TABLE OF INFORMATION DEVELOPED FOR 2012 (see note on cover page)

CONSTANTS AND CONVERSION FACTORS	
Proton mass, $m_p = 1.67 \times 10^{-27}$ kg	Electron charge magnitude, $e = 1.60 \times 10^{-19}$ C
Neutron mass, $m_n = 1.67 \times 10^{-27}$ kg	1 electron volt, $1 \text{ eV} = 1.60 \times 10^{-19}$ J
Electron mass, $m_e = 9.11 \times 10^{-31}$ kg	Speed of light, $c = 3.00 \times 10^8$ m/s
Avogadro's number, $N_0 = 6.02 \times 10^{23}$ mol ⁻¹	Universal gravitational constant, $G = 6.67 \times 10^{-11}$ m ³ /kg·s ²
Universal gas constant, $R = 8.31$ J/(mol·K)	Acceleration due to gravity at Earth's surface, $g = 9.8$ m/s ²
Boltzmann's constant, $k_B = 1.38 \times 10^{-23}$ J/K	
1 unified atomic mass unit,	$1 \text{ u} = 1.66 \times 10^{-27}$ kg = 931 MeV/c ²
Planck's constant,	$h = 6.63 \times 10^{-34}$ J·s = 4.14×10^{-15} eV·s
	$hc = 1.99 \times 10^{-25}$ J·m = 1.24×10^3 eV·nm
Vacuum permittivity,	$\epsilon_0 = 8.85 \times 10^{-12}$ C ² /N·m ²
Coulomb's law constant, $k = 1/4\pi\epsilon_0 = 9.0 \times 10^9$ N·m ² /C ²	
Vacuum permeability,	$\mu_0 = 4\pi \times 10^{-7}$ (T·m)/A
Magnetic constant, $k' = \mu_0/4\pi = 1 \times 10^{-7}$ (T·m)/A	
1 atmosphere pressure,	$1 \text{ atm} = 1.0 \times 10^5$ N/m ² = 1.0×10^5 Pa

UNIT SYMBOLS	meter, m	mole, mol	watt, W	farad, F
	kilogram, kg	hertz, Hz	coulomb, C	tesla, T
	second, s	newton, N	volt, V	degree Celsius, °C
	ampere, A	pascal, Pa	ohm, Ω	electron-volt, eV
	kelvin, K	joule, J	henry, H	

PREFIXES		
Factor	Prefix	Symbol
10 ⁹	giga	G
10 ⁶	mega	M
10 ³	kilo	k
10 ⁻²	centi	c
10 ⁻³	milli	m
10 ⁻⁶	micro	μ
10 ⁻⁹	nano	n
10 ⁻¹²	pico	p

VALUES OF TRIGONOMETRIC FUNCTIONS FOR COMMON ANGLES							
θ	0°	30°	37°	45°	53°	60°	90°
$\sin \theta$	0	1/2	3/5	$\sqrt{2}/2$	4/5	$\sqrt{3}/2$	1
$\cos \theta$	1	$\sqrt{3}/2$	4/5	$\sqrt{2}/2$	3/5	1/2	0
$\tan \theta$	0	$\sqrt{3}/3$	3/4	1	4/3	$\sqrt{3}$	∞

The following conventions are used in this exam.

- I. Unless otherwise stated, the frame of reference of any problem is assumed to be inertial.
- II. The direction of any electric current is the direction of flow of positive charge (conventional current).
- III. For any isolated electric charge, the electric potential is defined as zero at an infinite distance from the charge.
- *IV. For mechanics and thermodynamics equations, W represents the work done on a system.

*Not on the Table of Information for Physics C, since Thermodynamics is not a Physics C topic.

ADVANCED PLACEMENT PHYSICS B EQUATIONS DEVELOPED FOR 2012

NEWTONIAN MECHANICS		ELECTRICITY AND MAGNETISM	
$v = v_0 + at$	$a =$ acceleration	$F = \frac{kq_1q_2}{r^2}$	$A =$ area
$x = x_0 + v_0t + \frac{1}{2}at^2$	$F =$ force	$\mathbf{E} = \frac{\mathbf{F}}{q}$	$B =$ magnetic field
$v^2 = v_0^2 + 2a(x - x_0)$	$f =$ frequency	$U_E = qV = \frac{kq_1q_2}{r}$	$C =$ capacitance
$\Sigma \mathbf{F} = \mathbf{F}_{net} = m\mathbf{a}$	$h =$ height	$E_{avg} = -\frac{V}{d}$	$d =$ distance
$F_{fric} \leq \mu N$	$J =$ impulse	$V = k\left(\frac{q_1}{r_1} + \frac{q_2}{r_2} + \frac{q_3}{r_3} + \dots\right)$	$E =$ electric field
$a_c = \frac{v^2}{r}$	$K =$ kinetic energy	$C = \frac{Q}{V}$	$\mathcal{E} =$ emf
$\tau = rF \sin \theta$	$k =$ spring constant	$C = \frac{\epsilon_0 A}{d}$	$F =$ force
$\mathbf{p} = m\mathbf{v}$	$\ell =$ length	$U_c = \frac{1}{2}QV = \frac{1}{2}CV^2$	$I =$ current
$\mathbf{J} = \mathbf{F}\Delta t = \Delta \mathbf{p}$	$m =$ mass	$I_{avg} = \frac{\Delta Q}{\Delta t}$	$\ell =$ length
$K = \frac{1}{2}mv^2$	$N =$ normal force	$R = \frac{\rho \ell}{A}$	$P =$ power
$\Delta U_g = mgh$	$P =$ power	$V = IR$	$Q =$ charge
$W = F\Delta r \cos \theta$	$p =$ momentum	$P = IV$	$q =$ point charge
$P_{avg} = \frac{W}{\Delta t}$	$r =$ radius or distance	$C_p = C_1 + C_2 + C_3 + \dots$	$R =$ resistance
$P = Fv \cos \theta$	$T =$ period	$\frac{1}{C_s} = \frac{1}{C_1} + \frac{1}{C_2} + \frac{1}{C_3} + \dots$	$r =$ distance
$\mathbf{F}_s = -k\mathbf{x}$	$t =$ time	$R_s = R_1 + R_2 + R_3 + \dots$	$t =$ time
$U_s = \frac{1}{2}kx^2$	$U =$ potential energy	$\frac{1}{R_p} = \frac{1}{R_1} + \frac{1}{R_2} + \frac{1}{R_3} + \dots$	$U =$ potential (stored) energy
$T_s = 2\pi\sqrt{\frac{m}{k}}$	$v =$ velocity or speed	$F_B = qvB \sin \theta$	$V =$ electric potential or potential difference
$T_p = 2\pi\sqrt{\frac{\ell}{g}}$	$W =$ work done on a system	$F_B = BI\ell \sin \theta$	$v =$ velocity or speed
$T = \frac{1}{f}$	$x =$ position	$B = \frac{\mu_0 I}{2\pi r}$	$\rho =$ resistivity
$F_G = -\frac{Gm_1m_2}{r^2}$	$\mu =$ coefficient of friction	$\phi_m = BA \cos \theta$	$\theta =$ angle
$U_G = -\frac{Gm_1m_2}{r}$	$\theta =$ angle	$\mathcal{E}_{avg} = -\frac{\Delta \phi_m}{\Delta t}$	$\phi_m =$ magnetic flux
	$\tau =$ torque	$\mathcal{E} = B\ell v$	

ADVANCED PLACEMENT PHYSICS B EQUATIONS DEVELOPED FOR 2012

FLUID MECHANICS AND THERMAL PHYSICS

$\rho = m/V$ $P = P_0 + \rho gh$ $F_{buoy} = \rho Vg$ $A_1 v_1 = A_2 v_2$ $P + \rho gy + \frac{1}{2} \rho v^2 = \text{const.}$ $\Delta \ell = \alpha \ell_0 \Delta T$ $H = \frac{kA\Delta T}{L}$ $P = \frac{F}{A}$ $PV = nRT = Nk_B T$ $K_{avg} = \frac{3}{2} k_B T$ $v_{rms} = \sqrt{\frac{3RT}{M}} = \sqrt{\frac{3k_B T}{\mu}}$ $W = -P\Delta V$ $\Delta U = Q + W$ $e = \left \frac{W}{Q_H} \right $ $e_c = \frac{T_H - T_C}{T_H}$	$A = \text{area}$ $e = \text{efficiency}$ $F = \text{force}$ $h = \text{depth}$ $H = \text{rate of heat transfer}$ $k = \text{thermal conductivity}$ $K_{avg} = \text{average molecular kinetic energy}$ $\ell = \text{length}$ $L = \text{thickness}$ $m = \text{mass}$ $M = \text{molar mass}$ $n = \text{number of moles}$ $N = \text{number of molecules}$ $P = \text{pressure}$ $Q = \text{heat transferred to a system}$ $T = \text{temperature}$ $U = \text{internal energy}$ $V = \text{volume}$ $v = \text{velocity or speed}$ $v_{rms} = \text{root-mean-square velocity}$ $W = \text{work done on a system}$ $y = \text{height}$ $\alpha = \text{coefficient of linear expansion}$ $\mu = \text{mass of molecule}$ $\rho = \text{density}$
--	---

ATOMIC AND NUCLEAR PHYSICS

$E = hf = pc$ $K_{max} = hf - \phi$ $\lambda = \frac{h}{p}$ $\Delta E = (\Delta m)c^2$	$E = \text{energy}$ $f = \text{frequency}$ $K = \text{kinetic energy}$ $m = \text{mass}$ $p = \text{momentum}$ $\lambda = \text{wavelength}$ $\phi = \text{work function}$
--	--

WAVES AND OPTICS

$v = f\lambda$ $n = \frac{c}{v}$ $n_1 \sin \theta_1 = n_2 \sin \theta_2$ $\sin \theta_c = \frac{n_2}{n_1}$ $\frac{1}{s_i} + \frac{1}{s_o} = \frac{1}{f}$ $M = \frac{h_i}{h_o} = -\frac{s_i}{s_o}$ $f = \frac{R}{2}$ $d \sin \theta = m\lambda$ $x_m \approx \frac{m\lambda L}{d}$	$d = \text{separation}$ $f = \text{frequency or focal length}$ $h = \text{height}$ $L = \text{distance}$ $M = \text{magnification}$ $m = \text{an integer}$ $n = \text{index of refraction}$ $R = \text{radius of curvature}$ $s = \text{distance}$ $v = \text{speed}$ $x = \text{position}$ $\lambda = \text{wavelength}$ $\theta = \text{angle}$
---	--

GEOMETRY AND TRIGONOMETRY

<p>Rectangle $A = bh$</p> <p>Triangle $A = \frac{1}{2}bh$</p> <p>Circle $A = \pi r^2$ $C = 2\pi r$</p> <p>Rectangular Solid $V = \ell wh$</p> <p>Cylinder $V = \pi r^2 \ell$ $S = 2\pi r \ell + 2\pi r^2$</p> <p>Sphere $V = \frac{4}{3}\pi r^3$ $S = 4\pi r^2$</p> <p>Right Triangle $a^2 + b^2 = c^2$ $\sin \theta = \frac{a}{c}$ $\cos \theta = \frac{b}{c}$ $\tan \theta = \frac{a}{b}$</p>	$A = \text{area}$ $C = \text{circumference}$ $V = \text{volume}$ $S = \text{surface area}$ $b = \text{base}$ $h = \text{height}$ $\ell = \text{length}$ $w = \text{width}$ $r = \text{radius}$
---	--

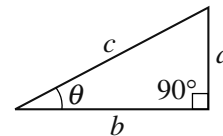

ADVANCED PLACEMENT PHYSICS C EQUATIONS DEVELOPED FOR 2012

MECHANICS

$v = v_0 + at$	$a =$ acceleration
$x = x_0 + v_0t + \frac{1}{2}at^2$	$F =$ force
$v^2 = v_0^2 + 2a(x - x_0)$	$f =$ frequency
$\Sigma \mathbf{F} = \mathbf{F}_{net} = m\mathbf{a}$	$h =$ height
$\mathbf{F} = \frac{d\mathbf{p}}{dt}$	$I =$ rotational inertia
$\mathbf{J} = \int \mathbf{F} dt = \Delta \mathbf{p}$	$J =$ impulse
$\mathbf{p} = m\mathbf{v}$	$K =$ kinetic energy
$F_{fric} \leq \mu N$	$k =$ spring constant
$W = \int \mathbf{F} \cdot d\mathbf{r}$	$\ell =$ length
$K = \frac{1}{2}mv^2$	$L =$ angular momentum
$P = \frac{dW}{dt}$	$m =$ mass
$P = \mathbf{F} \cdot \mathbf{v}$	$N =$ normal force
$\Delta U_g = mgh$	$P =$ power
$a_c = \frac{v^2}{r} = \omega^2 r$	$p =$ momentum
$\boldsymbol{\tau} = \mathbf{r} \times \mathbf{F}$	$r =$ radius or distance
$\Sigma \boldsymbol{\tau} = \boldsymbol{\tau}_{net} = I\boldsymbol{\alpha}$	$\mathbf{r} =$ position vector
$I = \int r^2 dm = \Sigma mr^2$	$T =$ period
$\mathbf{r}_{cm} = \Sigma m\mathbf{r} / \Sigma m$	$t =$ time
$v = r\omega$	$U =$ potential energy
$\mathbf{L} = \mathbf{r} \times \mathbf{p} = I\boldsymbol{\omega}$	$v =$ velocity or speed
$K = \frac{1}{2}I\omega^2$	$W =$ work done on a system
$\omega = \omega_0 + \alpha t$	$x =$ position
$\theta = \theta_0 + \omega_0 t + \frac{1}{2}\alpha t^2$	$\mu =$ coefficient of friction
	$\theta =$ angle
	$\tau =$ torque
	$\omega =$ angular speed
	$\alpha =$ angular acceleration
	$\phi =$ phase angle
	$\mathbf{F}_s = -k\mathbf{x}$
	$U_s = \frac{1}{2}kx^2$
	$x = x_{max} \cos(\omega t + \phi)$
	$T = \frac{2\pi}{\omega} = \frac{1}{f}$
	$T_s = 2\pi\sqrt{\frac{m}{k}}$
	$T_p = 2\pi\sqrt{\frac{\ell}{g}}$
	$\mathbf{F}_G = -\frac{Gm_1m_2}{r^2}\hat{\mathbf{r}}$
	$U_G = -\frac{Gm_1m_2}{r}$

ELECTRICITY AND MAGNETISM

$F = \frac{1}{4\pi\epsilon_0} \frac{q_1q_2}{r^2}$	$A =$ area
$\mathbf{E} = \frac{\mathbf{F}}{q}$	$B =$ magnetic field
$\oint \mathbf{E} \cdot d\mathbf{A} = \frac{Q}{\epsilon_0}$	$C =$ capacitance
$E = -\frac{dV}{dr}$	$d =$ distance
$V = \frac{1}{4\pi\epsilon_0} \sum_i \frac{q_i}{r_i}$	$E =$ electric field
$U_E = qV = \frac{1}{4\pi\epsilon_0} \frac{q_1q_2}{r}$	$\mathcal{E} =$ emf
$C = \frac{Q}{V}$	$F =$ force
$C = \frac{\kappa\epsilon_0 A}{d}$	$I =$ current
$C_p = \sum_i C_i$	$J =$ current density
$\frac{1}{C_s} = \sum_i \frac{1}{C_i}$	$L =$ inductance
$I = \frac{dQ}{dt}$	$\ell =$ length
$U_c = \frac{1}{2}QV = \frac{1}{2}CV^2$	$n =$ number of loops of wire per unit length
$R = \frac{\rho\ell}{A}$	$N =$ number of charge carriers per unit volume
$\mathbf{E} = \rho\mathbf{J}$	$P =$ power
$I = Nev_d A$	$Q =$ charge
$V = IR$	$q =$ point charge
$R_s = \sum_i R_i$	$R =$ resistance
$\frac{1}{R_p} = \sum_i \frac{1}{R_i}$	$r =$ distance
$P = IV$	$t =$ time
$\mathbf{F}_M = q\mathbf{v} \times \mathbf{B}$	$U =$ potential or stored energy
	$V =$ electric potential
	$v =$ velocity or speed
	$\rho =$ resistivity
	$\phi_m =$ magnetic flux
	$\kappa =$ dielectric constant
	$\oint \mathbf{B} \cdot d\boldsymbol{\ell} = \mu_0 I$
	$d\mathbf{B} = \frac{\mu_0}{4\pi} \frac{I d\boldsymbol{\ell} \times \mathbf{r}}{r^3}$
	$\mathbf{F} = \int I d\boldsymbol{\ell} \times \mathbf{B}$
	$B_s = \mu_0 nI$
	$\phi_m = \int \mathbf{B} \cdot d\mathbf{A}$
	$\mathcal{E} = \oint \mathbf{E} \cdot d\boldsymbol{\ell} = -\frac{d\phi_m}{dt}$
	$\mathcal{E} = -L \frac{dI}{dt}$
	$U_L = \frac{1}{2}LI^2$

ADVANCED PLACEMENT PHYSICS C EQUATIONS DEVELOPED FOR 2012

GEOMETRY AND TRIGONOMETRY

Rectangle

$$A = bh$$

Triangle

$$A = \frac{1}{2}bh$$

Circle

$$A = \pi r^2$$

$$C = 2\pi r$$

Rectangular Solid

$$V = \ell wh$$

Cylinder

$$V = \pi r^2 \ell$$

$$S = 2\pi r \ell + 2\pi r^2$$

Sphere

$$V = \frac{4}{3}\pi r^3$$

$$S = 4\pi r^2$$

Right Triangle

$$a^2 + b^2 = c^2$$

$$\sin \theta = \frac{a}{c}$$

$$\cos \theta = \frac{b}{c}$$

$$\tan \theta = \frac{a}{b}$$

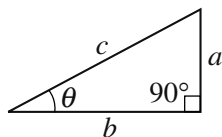

A = area
 C = circumference
 V = volume
 S = surface area
 b = base
 h = height
 ℓ = length
 w = width
 r = radius

CALCULUS

$$\frac{df}{dx} = \frac{df}{du} \frac{du}{dx}$$

$$\frac{d}{dx}(x^n) = nx^{n-1}$$

$$\frac{d}{dx}(e^x) = e^x$$

$$\frac{d}{dx}(\ln x) = \frac{1}{x}$$

$$\frac{d}{dx}(\sin x) = \cos x$$

$$\frac{d}{dx}(\cos x) = -\sin x$$

$$\int x^n dx = \frac{1}{n+1}x^{n+1}, n \neq -1$$

$$\int e^x dx = e^x$$

$$\int \frac{dx}{x} = \ln|x|$$

$$\int \cos x dx = \sin x$$

$$\int \sin x dx = -\cos x$$

Chapter 8

Electrostatics

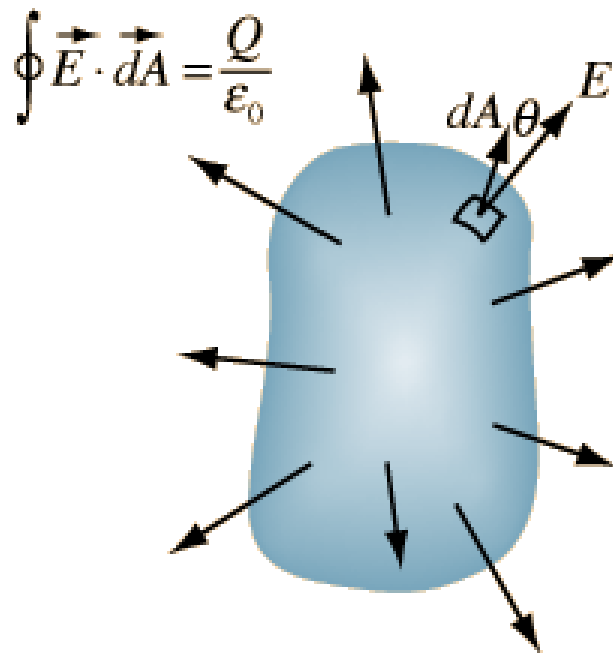

SECTION A – Coulomb’s Law and Coulomb’s Law Methods

1. A conducting sphere with a radius of 0.10 meter has 1.0×10^{-9} coulomb of charge deposited on it. The electric field just outside the surface of the sphere is
 (A) zero (B) 450 V/m (C) 900 V/m (D) 4,500 V/m (E) 90,000 V/m

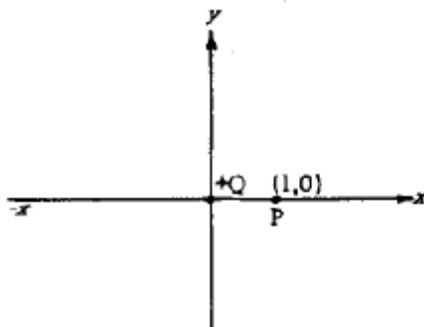

2. A positive charge $+Q$ located at the origin produces an electric field E_0 at point P ($x = +1, y = 0$). A negative charge $-2Q$ is placed at such a point as to produce a net field of zero at point P. The second charge will be placed on the
 (A) x-axis where $x > 1$ (B) x-axis where $0 < x < 1$ (C) x-axis where $x < 0$ (D) y-axis where $y > 0$
 (E) y-axis where $y < 0$

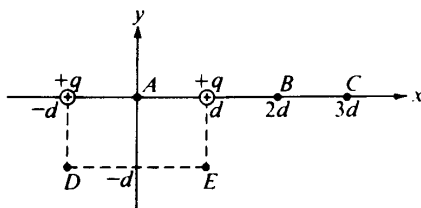

3. Two positive charges of magnitude q are each a distance d from the origin A of a coordinate system, as shown above. At which of the following points is the electric field least in magnitude?
 (A) A (B) B (C) C (D) D (E) E

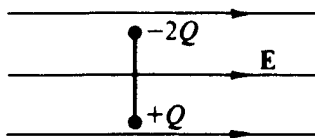

4. A rigid insulated rod, with two unequal charges attached to its ends, is placed in a uniform electric field E as shown above. The rod experiences a
 (A) net force to the left and a clockwise rotation
 (B) net force to the left and a counterclockwise rotation
 (C) net force to the right and a clockwise rotation
 (D) net force to the right and a counterclockwise rotation
 (E) rotation, but no net force

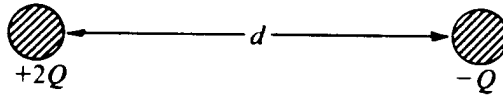

5. Two identical conducting spheres are charged to $+2Q$ and $-Q$, respectively, and are separated by a distance d (much greater than the radii of the spheres) as shown above. The magnitude of the force of attraction on the left sphere is F_1 . After the two spheres are made to touch and then are re-separated by distance d the magnitude of the force on the left sphere is F_2 . Which of the following relationships is correct?
 (A) $2F_1 = F_2$ (B) $F_1 = F_2$ (C) $F_1 = 2F_2$ (D) $F_1 = 4F_2$ (E) $F_1 = 8F_2$
6. Two small spheres have equal charges q and are separated by a distance d . The force exerted on each sphere by the other has magnitude F . If the charge on each sphere is doubled and d is halved, the force on each sphere has magnitude
 (A) F (B) $2F$ (C) $4F$ (D) $8F$ (E) $16F$
7. A charged particle traveling with a velocity \mathbf{v} in an electric field \mathbf{E} experiences a force \mathbf{F} that must be
 (A) parallel to \mathbf{v} (B) perpendicular to \mathbf{v} (C) parallel to $\mathbf{v} \times \mathbf{E}$ (D) parallel to \mathbf{E} (E) perpendicular to \mathbf{E}

Questions 8-9 relate to the following configurations of electric charges located at the vertices of an equilateral triangle. Point P is equidistant from the charges.

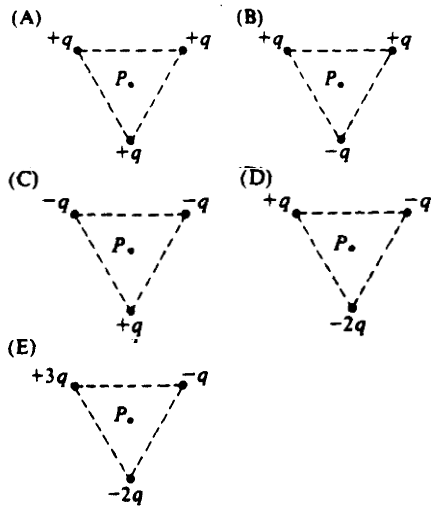

8. In which configuration is the electric field at P equal to zero?
 (A) (B) (C) (D) (E)
9. In which configuration is the electric field at P pointed at the midpoint between two of the charges?
 (A) (B) (C) (D) (E)

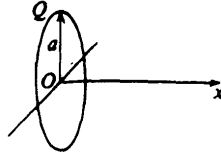

10. Positive charge Q is uniformly distributed over a thin ring of radius a that lies in a plane perpendicular to the x -axis, with its center at the origin O , as shown above. Which of the following graphs best represents the electric field along the positive x -axis?

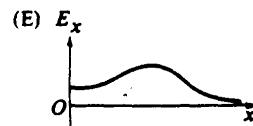
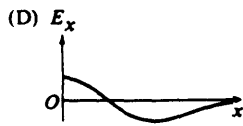
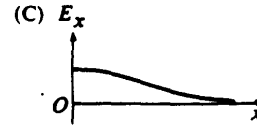
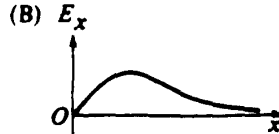
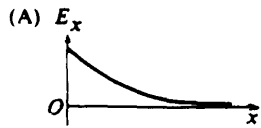

11. From the electric field vector at a point, one can determine which of the following?
- I. The direction of the electrostatic force on a test charge of known sign at that point
 - II. The magnitude of the electrostatic force exerted per unit charge on a test charge at that point
 - III. The electrostatic charge at that point
- A) I only B) III only C) I and II only D) II and III only E) I, II, and III

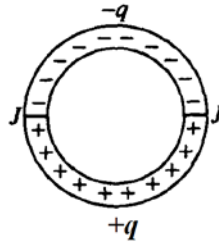

12. A circular ring made of an insulating material is cut in half. One half is given a charge $-q$ uniformly distributed along its arc. The other half is given a charge $+q$ also uniformly distributed along its arc. The two halves are then rejoined with insulation at the junctions J , as shown above. If there is no change in the charge distributions, what is the direction of the net electrostatic force on an electron located at the center of the circle?
- A) Toward the top of the page B) Toward the bottom of the page C) To the right
D) To the left E) Into the page.
13. A conducting sphere of radius R carries a charge Q . Another conducting sphere has a radius $R/2$, but carries the same charge. The spheres are far apart. The ratio of the electric field near the surface of the smaller sphere to the field near the surface of the larger sphere is most nearly
- A) $1/4$ B) $1/2$ C) 1 D) 2 E) 4

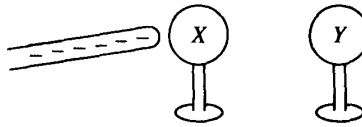

14. Two metal spheres that are initially uncharged are mounted on insulating stands, as shown above. A negatively charged rubber rod is brought close to, but does not make contact with, sphere X. Sphere Y is then brought close to X on the side opposite to the rubber rod. Y is allowed to touch X and then is removed some distance away. The rubber rod is then moved far away from X and Y. What are the final charges on the spheres?

<u>Sphere X</u>	<u>Sphere Y</u>
A) Zero	Zero
B) Negative	Negative
C) Negative	Positive
D) Positive	Negative
E) Positive	Positive

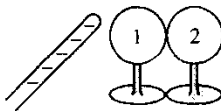

15. Two initially uncharged conductors, 1 and 2, are mounted on insulating stands and are in contact, as shown above. A negatively charged rod is brought near but does not touch them. With the rod held in place, conductor 2 is moved to the right by pushing its stand, so that the conductors are separated. Which of the following is now true of conductor 2?
- (A) It is uncharged. (B) It is positively charged. (C) It is negatively charged.
 (D) It is charged, but its sign cannot be predicted.
 (E) It is at the same potential that it was before the charged rod was brought near.

Questions 16-17

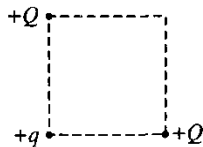

As shown above, two particles, each of charge $+Q$, are fixed at opposite corners of a square that lies in the plane of the page. A positive test charge $+q$ is placed at a third corner.

16. What is the direction of the force on the test charge due to the two other charges?

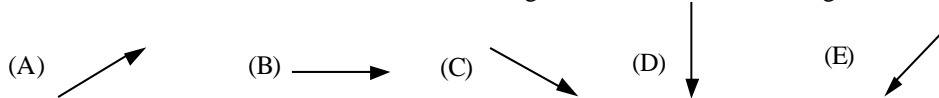

17. If F is the magnitude of the force on the test charge due to only one of the other charges, what is the magnitude of the net force acting on the test charge due to both of these charges?

(A) Zero	(B) $\frac{F}{\sqrt{2}}$	(C) F	(D) $\sqrt{2}F$	(E) $2F$
----------	--------------------------	---------	-----------------	----------

18. If the only force acting on an electron is due to a uniform electric field, the electron moves with constant
- (A) acceleration in a direction opposite to that of the field
 (B) acceleration in the direction of the field
 (C) acceleration in a direction perpendicular to that of the field
 (D) speed in a direction opposite to that of the field
 (E) speed in the direction of the field

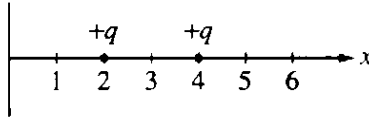

19. Two charged particles, each with a charge of $+q$, are located along the x -axis at $x = 2$ and $x = 4$, as shown above. Which of the following shows the graph of the magnitude of the electric field along the x -axis from the origin to $x = 6$?

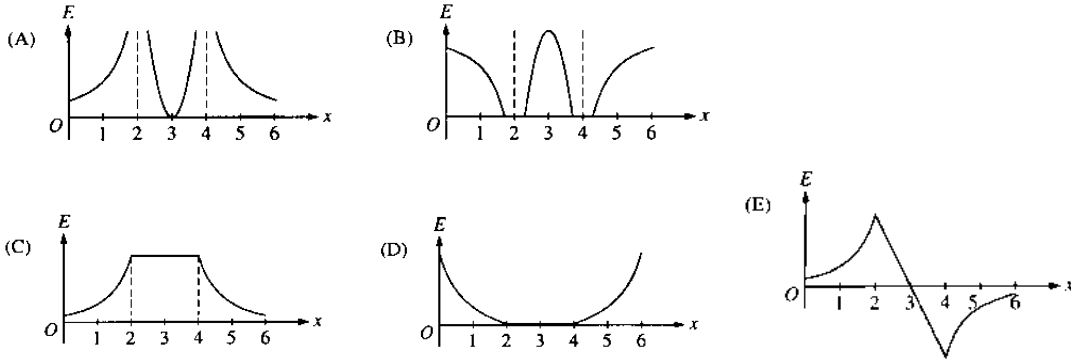

Questions 20-21

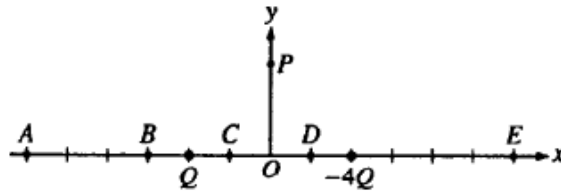

Particles of charge Q and $-4Q$ are located on the x -axis as shown in the figure above. Assume the particles are isolated from all other charges.

20. Which of the following describes the direction of the electric field at point P ?
 (A) $+x$ (B) $+y$ (C) $-y$
 (D) Components in both the $-x$ - and $+y$ -directions
 (E) Components in both the $+x$ - and $-y$ -directions
21. At which of the labeled points on the x -axis is the electric field zero?
 (A) A (B) B (C) C (D) D (E) E

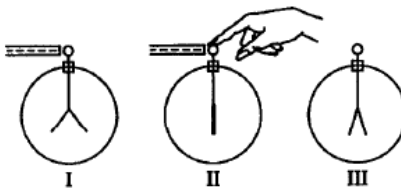

22. When a negatively charged rod is brought near, but does not touch, the initially uncharged electroscope shown above, the leaves spring apart (I). When the electroscope is then touched with a finger, the leaves collapse (II). When next the finger and finally the rod are removed, the leaves spring apart a second time (III). The charge on the leaves is
 (A) positive in both I and III (B) negative in both I and III (C) positive in I, negative in III
 (D) negative in I, positive in III (E) impossible to determine in either I or III

SECTION B – Gauss’s Law

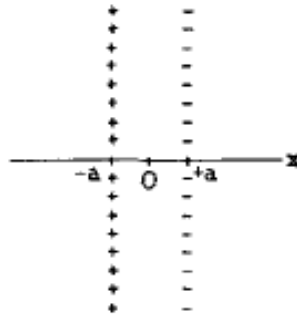

23. Two infinite parallel sheets of charge perpendicular to the x -axis have equal and opposite charge densities as shown above. The sheet that intersects $x = -a$ has uniform positive surface charge density; the sheet that intersects $x = +a$ has uniform negative surface charge density. Which graph best represents the plot of electric field as a function of x ?

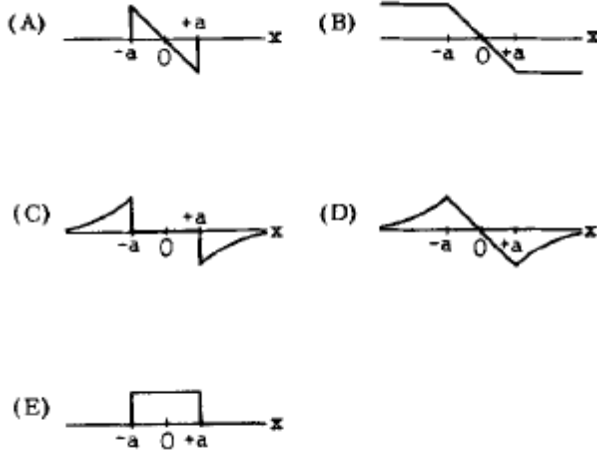

24. A point charge is placed at the center of an uncharged, spherical, conducting shell of radius R . The electric fields inside and outside the sphere are measured. The point charge is then moved off center a distance $R/2$ and the fields are measured again. What is the effect on the electric fields?
 (A) Changed neither inside nor outside (B) Changed inside but not changed outside
 (C) Not changed inside but changed outside (D) Changed inside and outside
 (E) It cannot be determined without further information.

25. The electric field E just outside the surface of a charged conductor is
 (A) directed perpendicular to the surface (B) directed parallel to the surface
 (C) independent of the surface charge density (D) zero (E) infinite

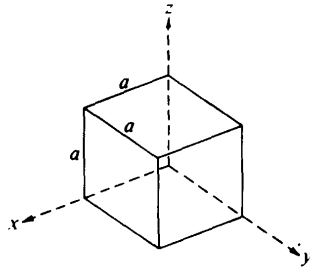

26. A closed surface, in the shape of a cube of side a , is oriented as shown above in a region where there is a constant electric field of magnitude E parallel to the x -axis. The total electric flux through the cubical surface is
 (A) $-Ea^2$ (B) zero (C) Ea^2 (D) $2Ea^2$ (E) $6Ea^2$

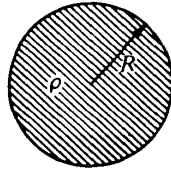

27. The figure above shows a spherical distribution of charge of radius R and constant charge density ρ . Which of the following graphs best represents the electric field strength E as a function of the distance r from the center of the sphere?

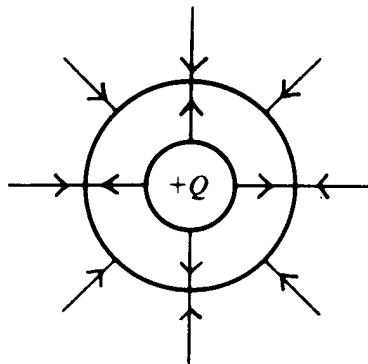
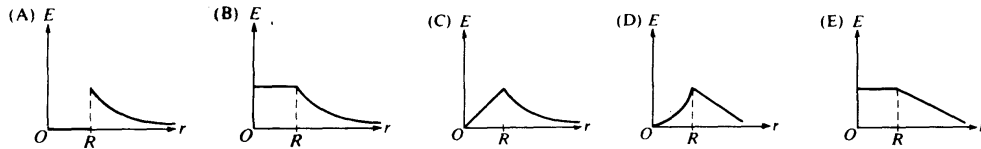

28. The electric field of two long coaxial cylinders is represented by lines of force as shown above. The charge on the inner cylinder is $+Q$. The charge on the outer cylinder is
 (A) $+3Q$ (B) $+Q$ (C) 0 (D) $-Q$ (E) $-3Q$

29. The net electric flux through a closed surface is
 A) infinite only if there are no charges enclosed by the surface
 B) infinite only if the net charge enclosed by the surface is zero
 C) zero if only negative charges are enclosed by the surface
 D) zero if only positive charges are enclosed by the surface
 E) zero if the net charge enclosed by the surface is zero

30. A solid nonconducting sphere of radius R has a charge Q uniformly distributed throughout its volume. A Gaussian surface of radius r with $r < R$ is used to calculate the magnitude of the electric field E at a distance r from the center of the sphere. Which of the following equations results from a correct application of Gauss's law for this situation?

A) $E(4\pi R^2) = Q/\epsilon_0$ B) $E(4\pi r^2) = Q/\epsilon_0$ C) $E(4\pi r^2) = (Q3r^3)/(\epsilon_0 4\pi R)$
 D) $E(4\pi r^2) = (Qr^3)/(\epsilon_0 R^3)$ E) $E(4\pi r^2) = 0$

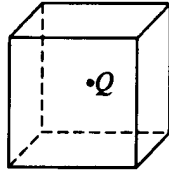

31. The point charge Q shown above is at the center of a metal box that is isolated, ungrounded, and uncharged. Which of the following is true?
 A) The net charge on the outside surface of the box is Q .
 B) The potential inside the box is zero.
 C) The electric field inside the box is constant.
 D) The electric field outside the box is zero everywhere.
 E) The electric field outside the box is the same as if only the point charge (and not the box) were there.
32. Gauss's law provides a convenient way to calculate the electric field outside and near each of the following isolated charged conductors EXCEPT a
 (A) large plate (B) sphere (C) cube (D) long, solid rod (E) long, hollow cylinder

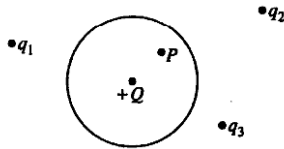

33. A point charge $+Q$ is inside an uncharged conducting spherical shell that in turn is near several isolated point charges, as shown above. The electric field at point P inside the shell depends on the magnitude of
 (A) Q only
 (B) the charge distribution on the sphere only
 (C) Q and the charge distribution on the sphere
 (D) all of the point charges
 (E) all of the point charges and the charge distribution on the sphere
34. A uniform spherical charge distribution has radius R . Which of the following is true of the electric field strength due to this charge distribution at a distance r from the center of the charge?
 (A) It is greatest when $r = 0$.
 (B) It is greatest when $r = R/2$.
 (C) It is directly proportional to r when $r > R$.
 (D) It is directly proportional to r when $r < R$.
 (E) It is directly proportional to r^2 .

SECTION C – Electric Potential and Energy

35. A distribution of charge is confined to a finite region of space. The difference in electric potential between any two points P_1 and P_2 due to this charge distribution depends only upon the
- (A) charges located at the points P_1 and P_2
 - (B) magnitude of a test charge moved from P_1 to P_2
 - (C) value of the electric field at P_1 and P_2
 - (D) path taken by a test charge moved from P_1 to P_2
 - (E) value of the integral $-\int_{P_1}^{P_2} \mathbf{E} \cdot d\mathbf{r}$

36. Two small spheres having charges of $+2Q$ and $-Q$ are located 12 centimeters apart. The potential of points lying on a line joining the charges is best represented as a function of the distance x from the positive charge by which of the following?

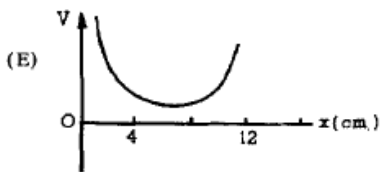
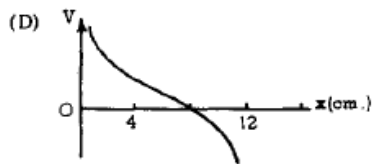
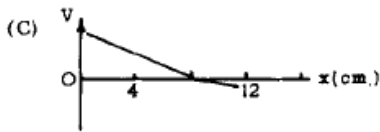
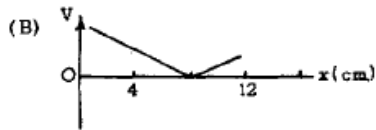
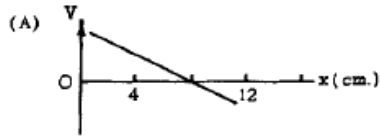

Questions 37-38 refer to five different charge configurations on the xy -plane using two or four point charges of equal magnitude having signs as indicated below. All charges are the same distance from the origin. The electric potential infinitely far from the origin is defined to be zero.

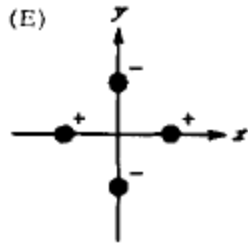
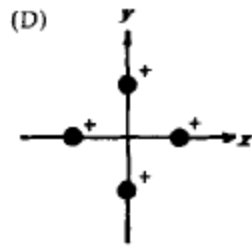
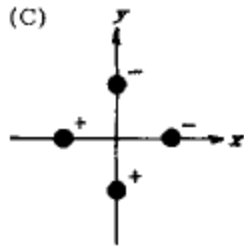
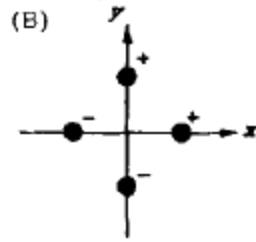
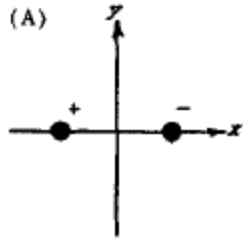

37. In which configuration are both the electric field and the electric potential at the origin equal to zero?
 (A) A (B) B (C) C (D) D (E) E

38. In which configuration is the value of the electric field at the origin equal to zero, but the electric potential at the origin not equal to zero?
 (A) A (B) B (C) C (D) D (E) E

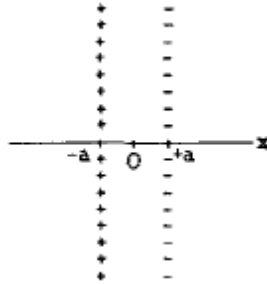

39. Two infinite parallel sheets of charge perpendicular to the x -axis have equal and opposite charge densities as shown above. The sheet that intersects $x = -a$ has uniform positive surface charge density; the sheet that intersects $x = +a$ has uniform negative surface charge density. Which graph best represents the plot of electric potential as a function of x ?

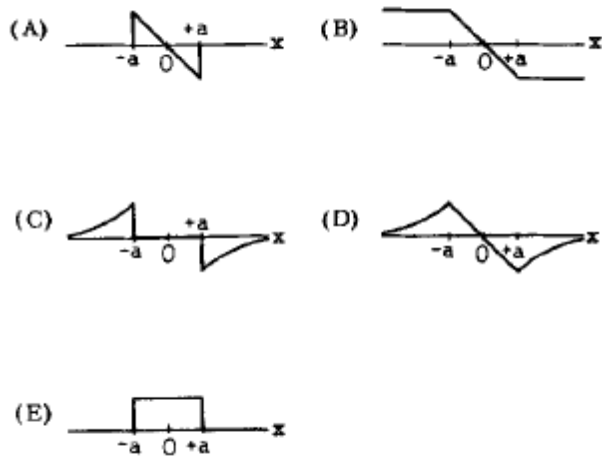

40. An insulated spherical conductor of radius r_0 carries a charge q . The electric potential due to this system varies as a function of the distance r from the center of the sphere in which of the following ways? (The potential is taken to be zero at $r = \infty$)

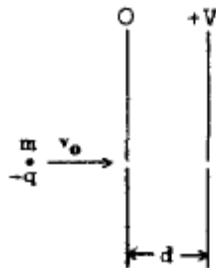
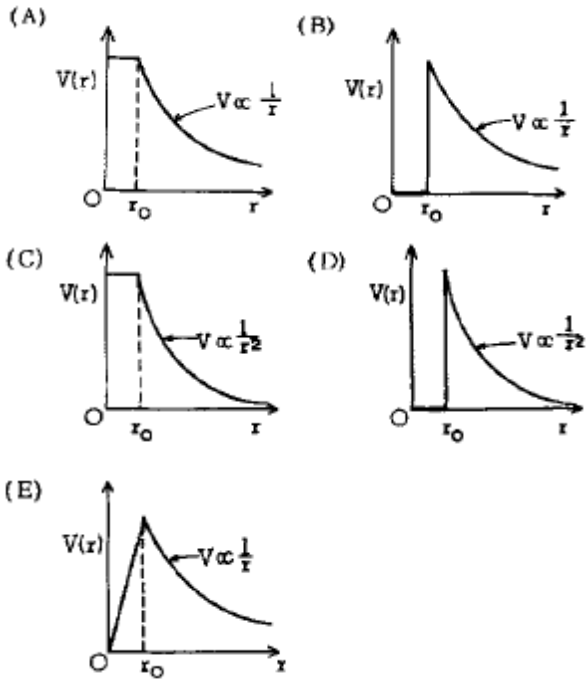

41. As shown in the diagram above, a charged particle having mass m and charge $-q$ is projected into the region between two parallel plates with a speed v_0 to the right. The potential difference between the plates is V and they are separated by a distance d . What is the net change in kinetic energy of the particle during the time it takes the particle to traverse the distance d ?

(A) $+\frac{1}{2}mv_0^2$ (B) $-qV/d$ (C) $\frac{+2qV}{mv_0^2}$ (D) $+qV$ (E) None of the above



42. Two conducting spheres, one having twice the diameter of the other, are shown above. The smaller sphere initially has a charge $+q$. When the spheres are connected by a thin wire, which of the following is true?
 (A) 1 and 2 are both at the same potential. (B) 2 has twice the potential of 1.
 (C) 2 has half the potential of 1. (D) 1 and 2 have equal charges. (E) All of the charge is dissipated.

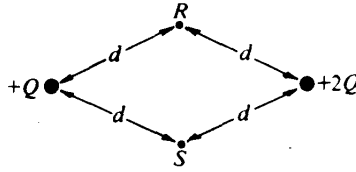

43. Points R and S are each the same distance d from two unequal charges, $+Q$ and $+2Q$, as shown above. The work required to move a charge $-Q$ from point R to point S is
 (A) dependent on the path taken from R to S (B) directly proportional to the distance between R and S
 (C) positive (D) zero (E) negative

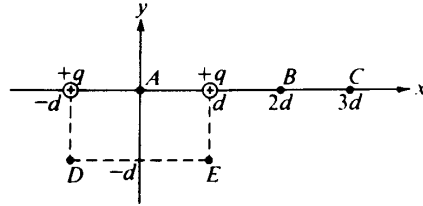

44. Two positive charges of magnitude q are each a distance d from the origin A of a coordinate system, as shown above. At which of the following points is the electric potential greatest in magnitude?
 (A) A (B) B (C) C (D) D (E) E

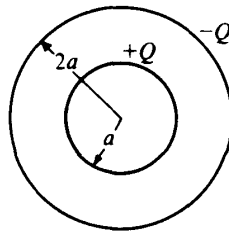

45. Concentric conducting spheres of radii a and $2a$ bear equal but opposite charges $+Q$ and $-Q$, respectively. Which of the following graphs best represents the electric potential V as a function of r ?

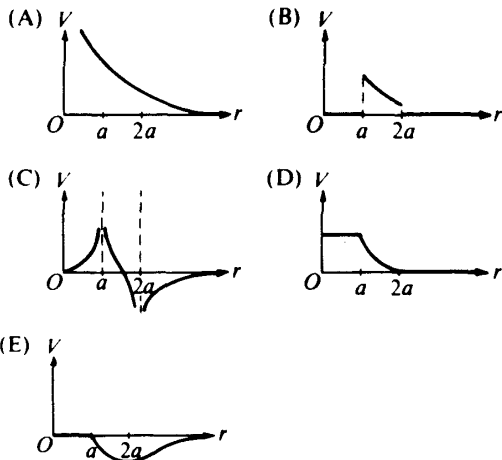

46. Which of the following statements about conductors under electrostatic conditions is true?
 (A) Positive work is required to move a positive charge over the surface of a conductor.
 (B) Charge that is placed on the surface of a conductor always spreads evenly over the surface.
 (C) The electric potential inside a conductor is always zero.
 (D) The electric field at the surface of a conductor is tangent to the surface.
 (E) The surface of a conductor is always an equipotential surface.

47. A positive charge of 3.0×10^{-8} coulomb is placed in an upward directed uniform electric field of 4.0×10^4 N/C. When the charge is moved 0.5 meter upward, the work done by the electric force on the charge is
 (A) 6×10^{-4} J (B) 12×10^{-4} J (C) 2×10^4 J (D) 8×10^4 J (E) 12×10^4 J

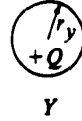
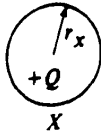

48. Two conducting spheres, X and Y, have the same positive charge $+Q$, but different radii ($r_x > r_y$) as shown above. The spheres are separated so that the distance between them is large compared with either radius. If a wire is connected between them, in which direction will current be directed in the wire?
 (A) From X to Y
 (B) From Y to X
 (C) There will be no current in the wire.
 (D) It cannot be determined without knowing the magnitude of Q .
 (E) It cannot be determined without knowing whether the spheres are solid or hollow.

Questions 49-50 refer to a sphere of radius R that has positive charge Q uniformly distributed on its surface

49. Which of the following represents the magnitude of the electric field E and the potential V as functions of r , the distance from the center of the sphere, when $r < R$?

\underline{E}	\underline{V}
(A) 0	kQ/R
(B) 0	kQ/r
(C) 0	0
(D) kQ/r^2	0
(E) kQ/R^2	0

50. Which of the following represents the magnitude, of the electric field E and the potential V as functions of r , the distance from the center of sphere, when $r > R$?

\underline{E}	\underline{V}
(A) kQ/R^2	kQ/R
(B) kQ/R	kQ/R
(C) kQ/R	kQ/r
(D) kQ/r^2	kQ/r
(E) kQ/r^2	kQ/r^2

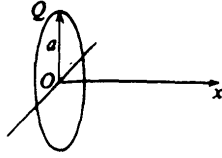

51. Positive charge Q is uniformly distributed over a thin ring of radius a that lies in a plane perpendicular to the x -axis, with its center at the origin O , as shown above. The potential V at points on the x -axis is represented by which of the following functions?

(A) $V(x) = \frac{kQ}{x^2 + a^2}$ (B) $V(x) = \frac{kQ}{\sqrt{a^2 + x^2}}$
 (C) $V(x) = \frac{kQ}{x^2}$ (D) $V(x) = \frac{kQ}{x}$ (E) $V(x) = \frac{kQ}{a + x}$

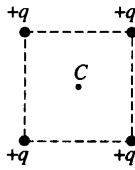

52. Four positive charges of magnitude q are arranged at the corners of a square, as shown above. At the center C of the square, the potential due to one charge alone is V_0 and the electric field due to one charge alone has magnitude E_0 . Which of the following correctly gives the electric potential and the magnitude of the electric field at the center of the square due to all four charges?

Electric Potential Electric Field

- A) Zero Zero
 B) Zero $2E_0$
 C) $2V_0$ $4E_0$
 D) $4V_0$ Zero
 E) $4V_0$ $2E_0$

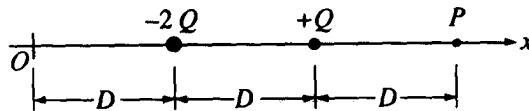

53. Two charges, $-2Q$ and $+Q$, are located on the x -axis, as shown above. Point P , at a distance of $3D$ from the origin O , is one of two points on the positive x -axis at which the electric potential is zero. How far from the origin O is the other point?
 A) $(2/3)D$ B) D C) $3/2D$ D) $5/3D$ E) $2D$
54. What is the radial component of the electric field associated with the potential $V = ar^{-2}$ where a is a constant?
 A) $-2ar^{-3}$ B) $-2ar^{-1}$ C) ar^{-1} D) $2ar^{-1}$ E) $2ar^{-3}$

Questions 55-56

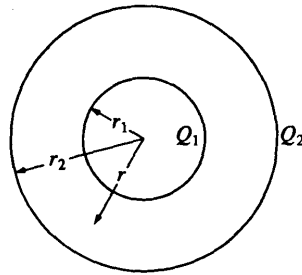

Two concentric, spherical conducting shells have radii r_1 and r_2 and charges Q_1 and Q_2 , as shown above. Let r be the distance from the center of the spheres and consider the region $r_1 < r < r_2$.

55. In this region the electric field is proportional to
 A) Q_1/r^2 B) $(Q_1 + Q_2)/r^2$ C) $(Q_1 + Q_2)/r$ D) $Q_1/r_1 + Q_2/r$ E) $Q_1/r + Q_2/r_2$
56. In this region the electric potential relative to infinity is proportional to
 A) Q_1/r^2 B) $(Q_1 + Q_2)/r^2$ C) $(Q_1 + Q_2)/r$ D) $Q_1/r_1 + Q_2/r$ E) $Q_1/r + Q_2/r_2$

Questions 57-58

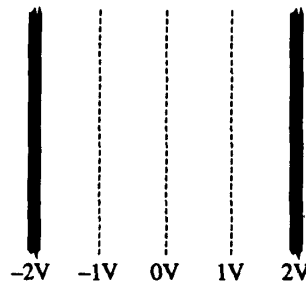

A battery or batteries connected to two parallel plates produce the equipotential lines between the plates shown above.

57. Which of the following configurations is most likely to produce these equipotential lines?

- (A)
- (B)
- (C)
- (D)
- (E)

58. The force on an electron located on the 0-volt potential line is
 A) 0 N
 B) 1 N, directed to the right
 C) 1 N, directed to the left
 D) directed to the right, but its magnitude cannot be determined without knowing the distance between the lines
 E) directed to the left, but its magnitude cannot be determined without knowing the distance between the lines
59. The potential of an isolated conducting sphere of radius R is given as a function of the charge q on the sphere by the equation $V = kq/R$. If the sphere is initially uncharged, the work W required to gradually increase the total charge on the sphere from zero to Q is given by which of the following expressions?
 A) $W = kQ/R$ B) $W = kQ^2/R$ C) $W = \int_0^Q (kq / R) dq$ D) $W = \int_0^Q (kq^2 / R) dq$
 E) $W = \int_0^Q (kq / R^2) dq$

Questions 60-61 refer to two charges located on the line shown in the figure below, in which the charge at point I is $+3q$ and the charge at point III is $+2q$. Point II is halfway between points I and III.

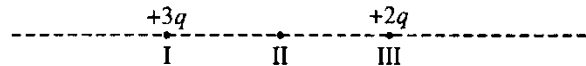

60. Other than at infinity, the electric field strength is zero at a point on the line in which of the following ranges?
 (A) To the left of I (B) Between I and II (C) Between II and III (D) To the right of III
 (E) None; the field is zero only at infinity.
61. The electric potential is negative at some points on the line in which of the following ranges?
 (A) To the left of I (B) Between I and II (C) Between II and III (D) To the right of III
 (E) None; this potential is never negative.

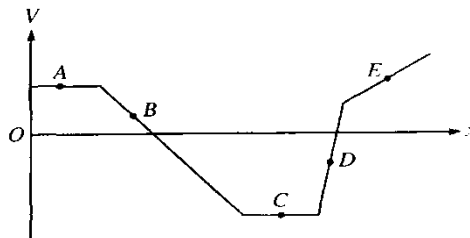

62. The graph above shows the electric potential V in a region of space as a function of position along the x -axis. At which point would a charged particle experience the force of greatest magnitude?
 (A) A (B) B (C) C (D) D (E) E:
63. The work that must be done by an external agent to move a point charge of 2 mC from the origin to a point 3 m away is 5 J. What is the potential difference between the two points?
 (A) 4×10^{-4} V (B) 10^{-2} V (C) 2.5×10^3 V (D) 2×10^6 V (E) 6×10^6 V
64. Suppose that an electron (charge $-e$) could orbit a proton (charge $+e$) in a circular orbit of constant radius R . Assuming that the proton is stationary and only electrostatic forces act on the particles, which of the following represents the kinetic energy of the two-particle system?
 (A) $\frac{1}{4\pi\epsilon_0} \frac{e}{R}$ (B) $\frac{1}{8\pi\epsilon_0} \frac{e^2}{R}$ (C) $-\frac{1}{8\pi\epsilon_0} \frac{e^2}{R}$ (D) $\frac{1}{4\pi\epsilon_0} \frac{e^2}{R^2}$ (E) $-\frac{1}{4\pi\epsilon_0} \frac{e^2}{R^2}$

Questions 65-66

In a region of space, a spherically symmetric electric potential is given as a function of r , the distance from the origin, by the equation $V(r) = kr^2$, where k is a positive constant.

65. What is the magnitude of the electric field at a point a distance r_0 from the origin?
 (A) Zero (B) kr_0 (C) $2kr_0$ (D) kr_0^2 (E) $2kr_0^3/3$
66. What is the direction of the electric field at a point a distance r_0 from the origin and the direction of the force on an electron placed at this point?
- | <u>Electric Field</u> | <u>Force on Electron</u> |
|--|------------------------------------|
| (A) Toward origin | Toward origin |
| (B) Toward origin | Away from origin |
| (C) Away from origin | Toward origin |
| (D) Away from origin | Away from origin |
| (E) Undefined, since the field is zero | Undefined, since the force is zero |
67. A positive electric charge is moved at a constant speed between two locations in an electric field, with no work done by or against the field at any time during the motion. This situation can occur only if the
 (A) charge is moved in the direction of the field
 (B) charge is moved opposite to the direction of the field
 (C) charge is moved perpendicular to an equipotential line
 (D) charge is moved along an equipotential line
 (E) electric field is uniform

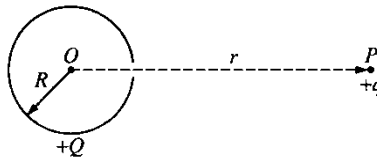

68. The nonconducting hollow sphere of radius R shown above carries a large charge $+Q$, which is uniformly distributed on its surface. There is a small hole in the sphere. A small charge $+q$ is initially located at point P , a distance r from the center of the sphere. If $k = 1/4\pi\epsilon_0$, what is the work that must be done by an external agent in moving the charge $+q$ from P through the hole to the center O of the sphere?
 (A) Zero (B) kqQ/r (C) kqQ/R (D) $kq(Q-q)/r$ (E) $kqQ(1/R - 1/r)$
69. In a certain region, the electric field along the x -axis is given by

$$E = ax + b, \text{ where } a = 40 \text{ V/m}^2 \text{ and } b = 4 \text{ V/m.}$$

The potential difference between the origin and $x = 0.5 \text{ m}$ is

- (A) -36 V (B) -7 V (C) -3 V (D) 10 V (E) 16 V
70. A $20 \mu\text{F}$ parallel-plate capacitor is fully charged to 30 V . The energy stored in the capacitor is most nearly
 (A) $9 \times 10^3 \text{ J}$ (B) $9 \times 10^{-3} \text{ J}$ (C) $6 \times 10^{-4} \text{ J}$ (D) $2 \times 10^{-4} \text{ J}$ (E) $2 \times 10^{-7} \text{ J}$

71. A potential difference V is maintained between two large, parallel conducting plates. An electron starts from rest on the surface of one plate and accelerates toward the other. Its speed as it reaches the second plate is proportional to
 (A) $1/V$ (B) $1/\sqrt{V}$ (C) \sqrt{V} (D) V (E) V^2

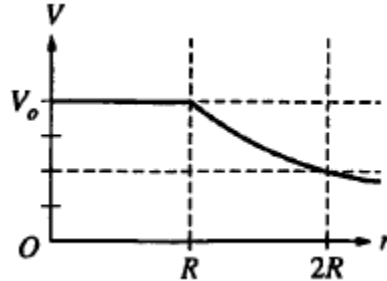

72. A solid metallic sphere of radius R has charge Q uniformly distributed on its outer surface. A graph of electric potential V as a function of position r is shown above. Which of the following graphs best represents the magnitude of the electric field E as a function of position r for this sphere?

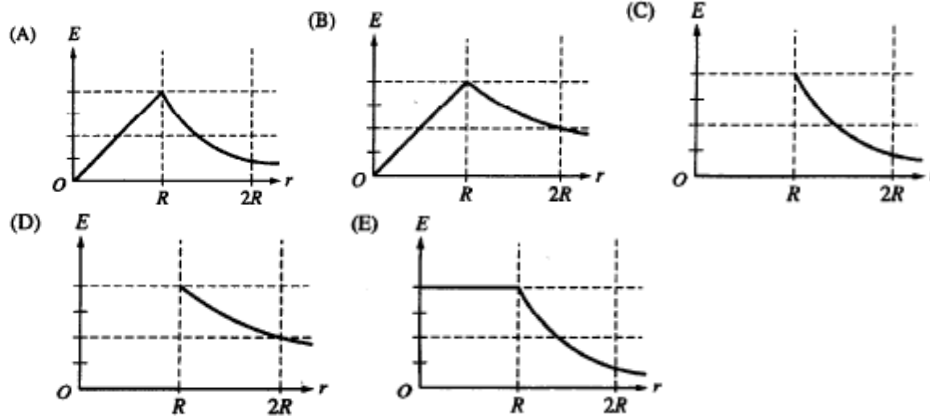

Questions 73-74

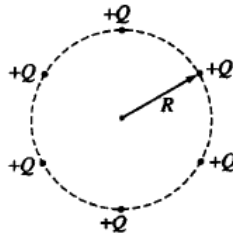

As shown in the figure above, six particles, each with charge $+Q$, are held fixed and are equally spaced around the circumference of a circle of radius R .

73. What is the magnitude of the resultant electric field at the center of the circle?
 (A) 0 (B) $\frac{\sqrt{6}}{4\pi\epsilon_0} \frac{Q}{R^2}$ (C) $\frac{2\sqrt{3}}{4\pi\epsilon_0} \frac{Q}{R^2}$ (D) $\frac{3\sqrt{2}}{4\pi\epsilon_0} \frac{Q}{R^2}$ (E) $\frac{3}{2\pi\epsilon_0} \frac{Q}{R^2}$

74. With the six particles held fixed, how much work would be required to bring a seventh particle of charge + Q from very far away and place it at the center of the circle?

- (A) 0 (B) $\frac{\sqrt{6} Q}{4\pi\epsilon_0 R}$ (C) $\frac{3 Q^2}{2\pi\epsilon_0 R^2}$
 (D) $\frac{3 Q^2}{2\pi\epsilon_0 R}$ (E) $\frac{9 Q^2}{\pi\epsilon_0 R}$

Questions 75-77

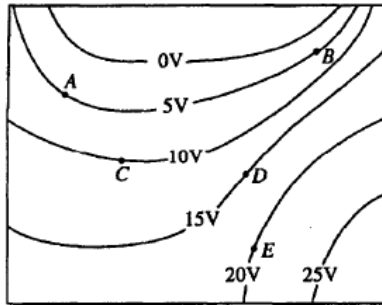

The diagram above shows equipotential lines produced by an unknown charge distribution. A, B, C, D, and E are points in the plane.

75. Which vector below best describes the direction of the electric field at point A ?

- (A)  (B) 
 (C)  (D) 

(E) None of these; the field is zero.

76. At which point does the electric field have the greatest magnitude?

- (A) A (B) B (C) C (D) D (E) E

77. How much net work must be done by an external force to move a $-1 \mu\text{C}$ point charge from rest at point C to rest at point E ?

- (A) $-20 \mu\text{J}$ (B) $-10 \mu\text{J}$ (C) $10 \mu\text{J}$ (D) $20 \mu\text{J}$ (E) $30 \mu\text{J}$

78. A physics problem starts: "A solid sphere has charge distributed uniformly throughout. . . ." It may be correctly concluded that the

- (A) electric field is zero everywhere inside the sphere
 (B) electric field inside the sphere is the same as the electric field outside
 (C) electric potential on the surface of the sphere is not constant
 (D) electric potential in the center of the sphere is zero
 (E) sphere is not made of metal

SECTION D – Capacitance

79. The two plates of a parallel-plate capacitor are a distance d apart and are mounted on insulating supports. A battery is connected across the capacitor to charge it and is then disconnected. The distance between the insulated plates is then increased to $2d$. If fringing of the field is still negligible, which of the following quantities is doubled?
- (A) The capacitance of the capacitor
 - (B) The total charge on the capacitor
 - (C) The surface density of the charge on the plates of the capacitor
 - (D) The energy stored in the capacitor
 - (E) The intensity of the electric field between the plates of the capacitor
80. A parallel-plate capacitor has a capacitance C_0 . A second parallel-plate capacitor has plates with twice the area and twice the separation. The capacitance of the second capacitor is most nearly
- (A) $\frac{1}{4}C_0$
 - (B) $\frac{1}{2}C_0$
 - (C) C_0
 - (D) $2C_0$
 - (E) $4C_0$

Questions 81-82

Three 6-microfarad capacitors are connected in series with a 6-volt battery.

81. The equivalent capacitance of the set of capacitors is
- (A) $0.5 \mu\text{F}$
 - (B) $2 \mu\text{F}$
 - (C) $3 \mu\text{F}$
 - (D) $9 \mu\text{F}$
 - (E) $18 \mu\text{F}$
82. The energy stored in each capacitor is
- (A) $4 \mu\text{J}$
 - (B) $6 \mu\text{J}$
 - (C) $12 \mu\text{J}$
 - (D) $18 \mu\text{J}$
 - (E) $36 \mu\text{J}$
83. An isolated capacitor with air between its plates has a potential difference V_0 and a charge Q_0 . After the space between the plates is filled with oil, the difference in potential is V and the charge is Q . Which of the following pairs of relationships is correct?
- (A) $Q=Q_0$ and $V>V_0$
 - (B) $Q=Q_0$ and $V<V_0$
 - (C) $Q>Q_0$ and $V=V_0$
 - (D) $Q<Q_0$ and $V<V_0$
 - (E) $Q>Q_0$ and $V>V_0$
84. When two identical parallel-plate capacitors are connected in series, which of the following is true of the equivalent capacitance?
- (A) It depends on the charge on each capacitor.
 - (B) It depends on the potential difference across both capacitors.
 - (C) It is larger than the capacitance of each capacitor.
 - (D) It is smaller than the capacitance of each capacitor.
 - (E) It is the same as the capacitance of each capacitor.
85. Which of the following can be used along with fundamental constants, but no other quantities, to calculate the magnitude of the electric field between the plates of a parallel-plate capacitor whose plate dimensions and spacing are not known?
- (A) The flux between the plates
 - (B) The total charge on either plate
 - (C) The potential difference between the plates
 - (D) The surface charge density on either plate
 - (E) The total energy stored in the capacitor

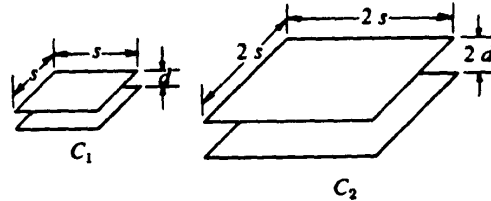

86. Two square parallel-plate capacitors of capacitances C_1 and C_2 have the dimensions shown in the diagrams above. The ratio of C_1 to C_2 is
 (A) 1 to 4 (B) 1 to 2 (C) 1 to 1 (D) 2 to 1 (E) 4 to 1
87. A sheet of mica is inserted between the plates of an isolated charged parallel-plate capacitor. Which of the following statements is true?
 (A) The capacitance decreases.
 (B) The potential difference across the capacitor decreases.
 (C) The energy of the capacitor does not change.
 (D) The charge on the capacitor plates decreases
 (E) The electric field between the capacitor plates increases.

Questions 88-89 refer to the system of six 2-microfarad capacitors shown below.

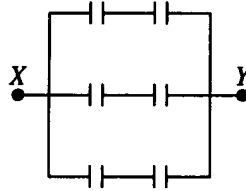

88. The equivalent capacitance of the system of capacitors is
 (A) $2/3 \mu\text{F}$ (B) $4/3 \mu\text{F}$ (C) $3 \mu\text{F}$ (D) $6 \mu\text{F}$ (E) $12 \mu\text{F}$
89. What potential difference must be applied between points X and Y so that the charge on each plate of each capacitor will have magnitude 6 microcoulombs?
 (A) 1.5 V (B) 3V (C) 6 V (D) 9 V (E) 18 V
90. Which of the following capacitors, each of which has plates of area A, would store the most charge on the top plate for a given potential difference V ?

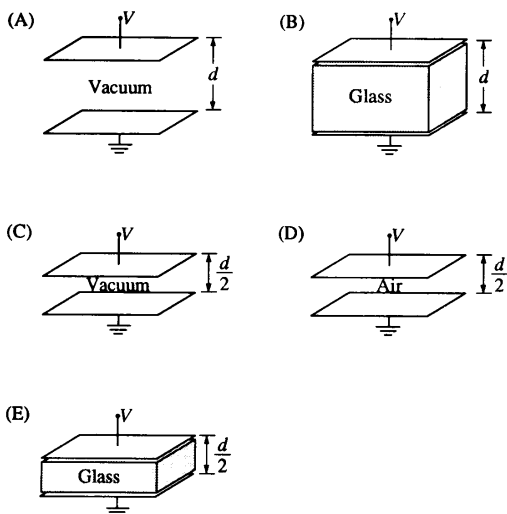

91. A parallel-plate capacitor has charge $+Q$ on one plate and charge $-Q$ on the other. The plates, each of area A , are a distance d apart and are separated by a vacuum. A single proton of charge $+e$, released from rest at the surface of the positively charged plate, will arrive at the other plate with kinetic energy proportional to

- (A) $\frac{edQ}{A}$ (B) $\frac{Q^2}{eAd}$ (C) $\frac{AeQ}{d}$ (D) $\frac{Q}{ed}$ (E) $\frac{eQ^2}{Ad}$

Questions 92-93

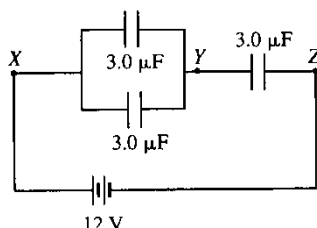

Three identical capacitors, each of capacitance $3.0 \mu\text{F}$, are connected in a circuit with a 12 V battery as shown above.

92. The equivalent capacitance between points X and Z is
 (A) $1.0 \mu\text{F}$ (B) $2.0 \mu\text{F}$ (C) $4.5 \mu\text{F}$ (D) $6.0 \mu\text{F}$ (E) $9.0 \mu\text{F}$
93. The potential difference between points Y and Z is
 (A) zero (B) 3 V (C) 4 V (D) 8 V (E) 9 V

Questions 94-95

A capacitor is constructed of two identical conducting plates parallel to each other and separated by a distance d . The capacitor is charged to a potential difference of V_0 by a battery, which is then disconnected.

94. If any edge effects are negligible, what is the magnitude of the electric field between the plates?
 (A) $V_0 d$ (B) V_0/d (C) d/V_0 (D) V_0/d^2 (E) V_0^2/d
95. A sheet of insulating plastic material is inserted between the plates without otherwise disturbing the system. What effect does this have on the capacitance?
 (A) It causes the capacitance to increase.
 (B) It causes the capacitance to decrease.
 (C) None; the capacitance does not change.
 (D) Nothing can be said about the effect without knowing the dielectric constant of the plastic.
 (E) Nothing can be said about the effect without knowing the thickness of the sheet.

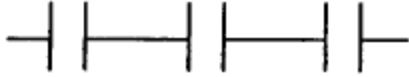

96. Three $\frac{1}{2} \mu\text{F}$ capacitors are connected in series as shown in the diagram above. The capacitance of the combination is (A) $0.1 \mu\text{F}$ (B) $1 \mu\text{F}$ (C) $\frac{2}{3} \mu\text{F}$ (D) $\frac{1}{2} \mu\text{F}$ (E) $\frac{1}{6} \mu\text{F}$

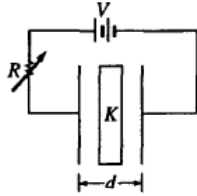

97. The plates of a parallel-plate capacitor of cross sectional area A are separated by a distance d , as shown above. Between the plates is a dielectric material of constant K . The plates are connected in series with a variable resistance R and a power supply of potential difference V . The capacitance C of this capacitor will increase if which of the following is decreased?
 (A) A (B) R (C) K (D) d (E) V

SECTION A – Coulomb’s Law and Coulomb’s Law Methods

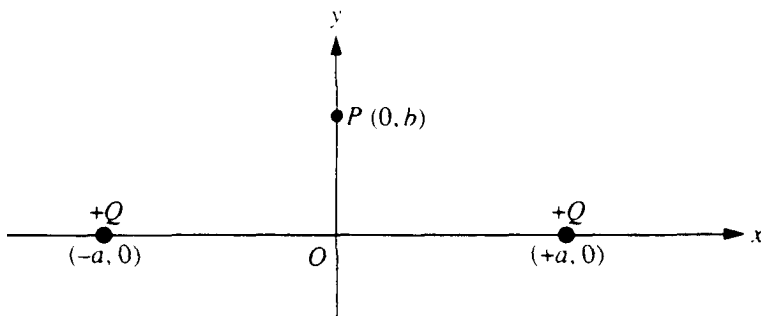

1991E1. Two equal positive charges Q are fixed on the x -axis, one at $+a$ and the other at $-a$, as shown above. Point P is a point on the y -axis with coordinates $(0, b)$. Determine each of the following in terms of the given quantities and fundamental constants.

- The electric field E at the origin O
- The electric potential V at the origin O .
- The magnitude of the electric field E at point P .

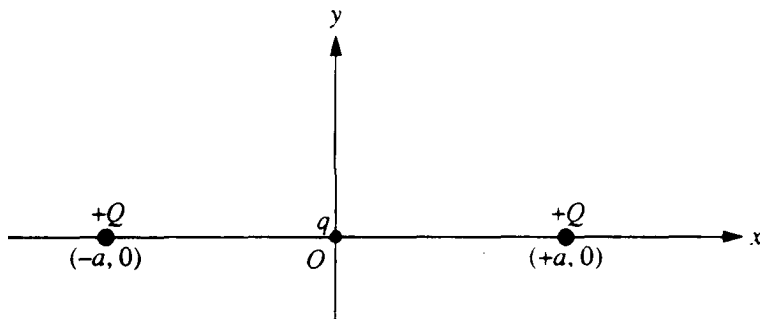

A small particle of charge q ($q \ll Q$) and mass m is placed at the origin, displaced slightly, and then released. Assume that the only subsequent forces acting are the electric forces from the two fixed charges Q , at $x = +a$ and $x = -a$, and that the particle moves only in the xy -plane. In each of the following cases, describe briefly the motion of the charged particle after it is released. Write an expression for its speed when far away if the resulting force pushes it away from the origin.

- q is positive and is displaced in the $+x$ direction.
- q is positive and is displaced in the $+y$ direction.
- q is negative and is displaced in the $+y$ direction.

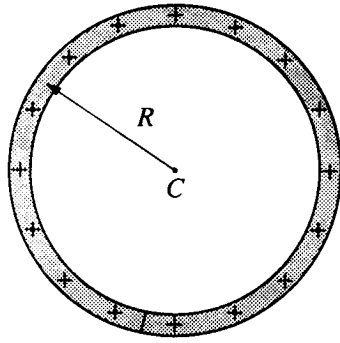

- 1994E1. A thin nonconducting rod that carries a uniform charge per unit length of λ is bent into a circle of radius R , as shown above. Express your answers in terms of λ , R , and fundamental constants.
- Determine the electric potential V at the center C of the circle.
 - Determine the magnitude E of the electric field at the center C of the circle.

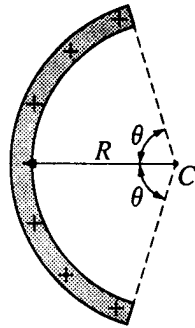

- Another thin nonconducting rod that carries the same uniform charge per unit length λ is bent into an arc of a circle of radius R , which subtends an angle of 2θ , as shown above. Express your answers in terms of λ and the quantities given above.
- Determine the total charge on the rod.
 - Determine the electric potential V at the center of curvature C of the arc.
 - Determine the magnitude E of the electric field at the center of curvature C of the arc. Indicate the direction of the electric field on the diagram above.

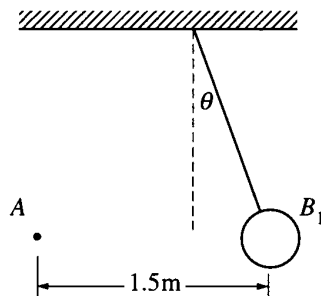

Note: Figure not drawn to scale.

1998E1. The small sphere A in the diagram above has a charge of $120 \mu\text{C}$. The large sphere B_1 is a thin shell of nonconducting material with a net charge that is uniformly distributed over its surface. Sphere B_1 has a mass of 0.025 kg , a radius of 0.05 m , and is suspended from an uncharged, nonconducting thread. Sphere B_1 is in equilibrium when the thread makes an angle $\theta = 20^\circ$ with the vertical. The centers of the spheres are at the same vertical height and are a horizontal distance of 1.5 m apart, as shown.

- Calculate the charge on sphere B_1 .
- Suppose that sphere B_1 is replaced by a second suspended sphere B_2 that has the same mass, radius, and charge, but that is conducting. Equilibrium is again established when sphere A is 1.5 m from sphere B_2 and their centers are at the same vertical height. State whether the equilibrium angle θ_2 will be less than, equal to, or greater than 20° . Justify your answer.

The sphere B_2 is now replaced by a very long, horizontal, nonconducting tube, as shown in the top view below. The tube is hollow with thin walls of radius $R = 0.20 \text{ m}$ and a uniform positive charge per unit length of $\lambda = +0.10 \mu\text{C}/\text{m}$.

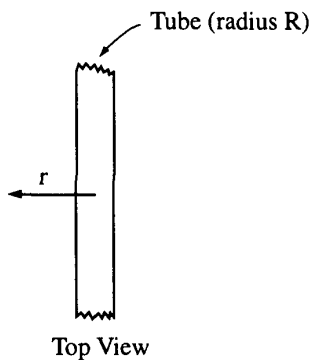

- Use Gauss's law to show that the electric field at a perpendicular distance r from the tube is given by the expression $E = (1.8 \times 10^3)/r \text{ N/C}$, where $r > R$ and r is in meters.
- The small sphere A with charge $120 \mu\text{C}$ is now brought into the vicinity of the tube and is held at a distance of $r = 1.5 \text{ m}$ from the center of the tube. Calculate the repulsive force that the tube exerts on the sphere.
- Calculate the work done against the electrostatic repulsion to move sphere A toward the tube from a distance $r = 1.5 \text{ m}$ to a distance $r = 0.3 \text{ m}$ from the tube.

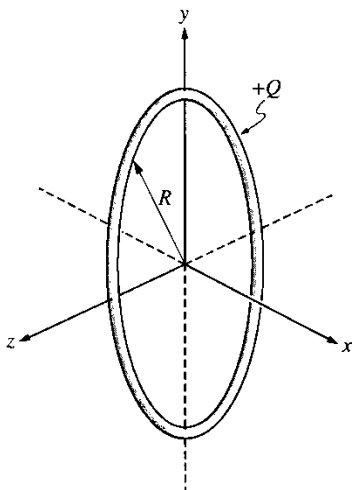

1999E3. The nonconducting ring of radius R shown above lies in the yz -plane and carries a uniformly distributed positive charge Q .

- a. Determine the electric potential at points along the x -axis as a function of x .
- b. i. Show that the x -component of the electric field along the x -axis is given by

$$E_x = \frac{Qx}{4\pi\epsilon_0(R^2 + x^2)^{\frac{3}{2}}}$$

- ii. What are the y - and z - components of the electric field along the x -axis?
- c. Determine the following.
 - i. The value of x for which E_x is a maximum
 - ii. The maximum electric field $E_{x \text{ max}}$
- d. On the axes below, sketch E_x versus x for points on the x -axis from $x = -2R$ to $x = +2R$.

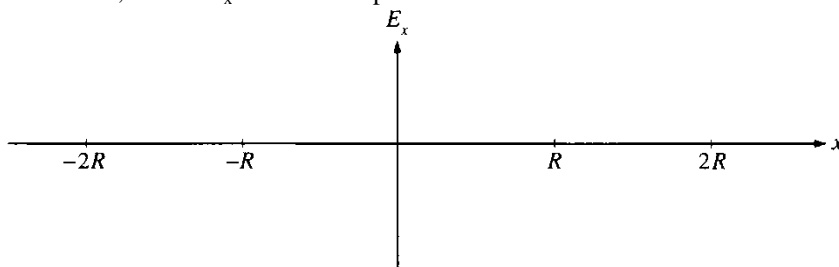

- e. An electron is placed at $x = R/2$ and released from rest. Qualitatively describe its subsequent motion.

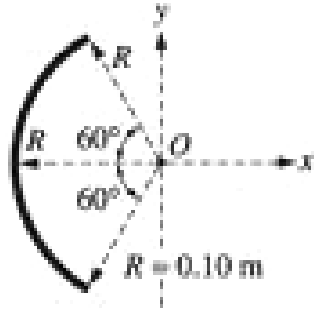

2002E1. A rod of uniform linear charge density $\lambda = +1.5 \times 10^{-5} \text{ C/m}$ is bent into an arc of radius $R = 0.10 \text{ m}$. The arc is placed with its center at the origin of the axes shown above.

- Determine the total charge on the rod.
- Determine the magnitude and direction of the electric field at the center O of the arc.
- Determine the electric potential at point O .

A proton is now placed at point O and held in place. Ignore the effects of gravity in the rest of this problem.

- Determine the magnitude and direction of the force that must be applied in order to keep the proton at rest.
- The proton is now released. Describe in words its motion for a long time after its release.

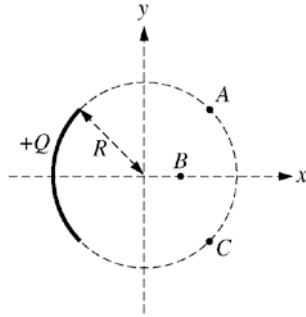

Figure I

2010E1. A charge $+Q$ is uniformly distributed over a quarter circle of radius R , as shown above. Points A , B , and C are located as shown, with A and C located symmetrically relative to the x -axis. Express all algebraic answers in terms of the given quantities and fundamental constants.

- a. Rank the magnitude of the electric potential at points A , B , and C from greatest to least, with number 1 being greatest. If two points have the same potential, give them the same ranking.

_____ V_A _____ V_B _____ V_C
 Justify your rankings.

Point P is at the origin, as shown below, and is the center of curvature of the charge distribution.

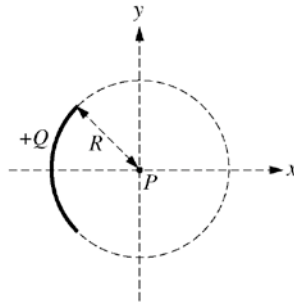
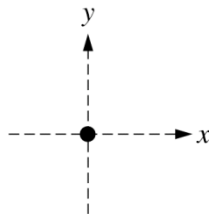

Figure II

- b. Determine an expression for the electric potential at point P due to the charge Q .
 c. A positive point charge q with mass m is placed at point P and released from rest. Derive an expression for the speed of the point charge when it is very far from the origin.
 d. On the dot representing point P below, indicate the direction of the electric field at point P due to the charge Q .



- e. Derive an expression for the magnitude of the electric field at point P .

SECTION B – Gauss's Law

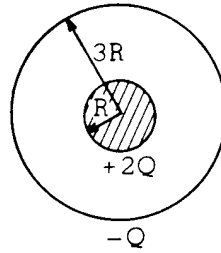

1976E1. A solid metal sphere of radius R has charge $+2Q$. A hollow spherical shell of radius $3R$ placed concentric with the first sphere has net charge $-Q$.

- a. On the diagram below, make a sketch of the electric field lines inside and outside the spheres.

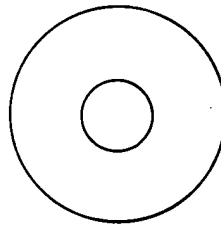

- b. Use Gauss's law to find an expression for the magnitude of the electric field between the spheres at a distance r from the center of the inner sphere ($R < r < 3R$).
- c. Calculate the potential difference between the two spheres.
- d. What would be the final distribution of the charge if the spheres were joined by a conducting wire?

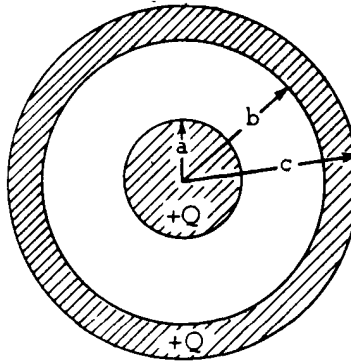

1979E1. A solid conducting sphere of radius a is surrounded by a hollow conducting shell of inner radius b and outer radius c as shown above. The sphere and the shell each have a charge $+Q$. Express your answers to parts (a), (b) and (e) in terms of Q , a , b , c , and the Coulomb's law constant.

- Using Gauss's law, derive an expression for the electric field magnitude at $a < r < b$, where r is the distance from the center of the solid sphere.
- Write expressions for the electric field magnitude at $r > c$, $b < r < c$, and $r < a$. Full credit will be given for statements of the correct expressions. It is not necessary to show your work on this part.
- On the axes below, sketch a graph of the electric field magnitude E vs. distance r from the center of the solid sphere.

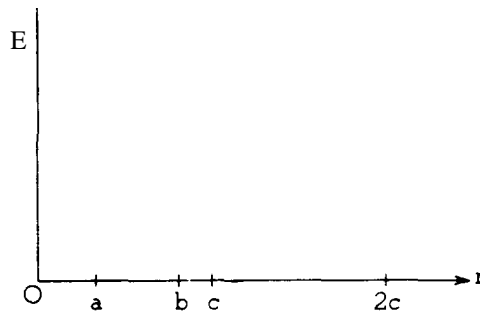

- On the axes below, sketch a graph of potential V vs. distance r from the center of the solid sphere. (The potential V is zero at $r = \infty$.)

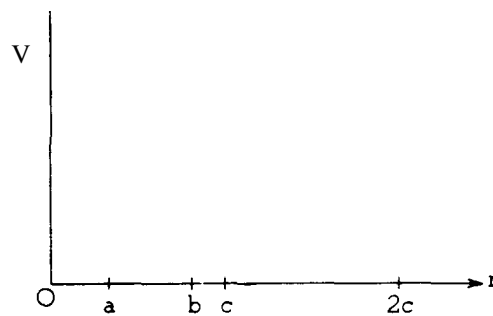

- Determine the Potential at $r = b$.

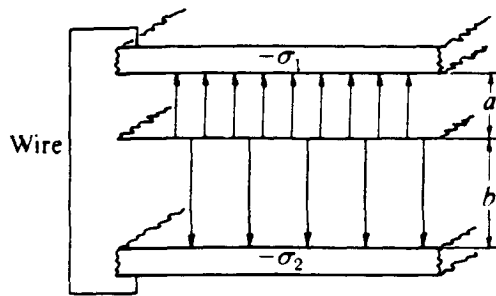

- 1984E2. Two large, parallel conducting plates are joined by a wire, as shown above, so that they are at the same potential. Between the plates, at a distance a from the upper plate and a distance b from the lower plate, is a thin, uniformly charged sheet whose charge per unit area is σ . The electric fields between the plates above and below the sheet have magnitudes E_1 and E_2 , respectively.
- Determine the ratio E_1/E_2 so that the potential difference between the outer plates is zero.
 - The Gaussian surface in the diagram immediately below has faces of area A parallel to the charged sheet. By applying Gauss's law to this surface, develop a relationship among E_1 , E_2 , a , and any appropriate fundamental constants.

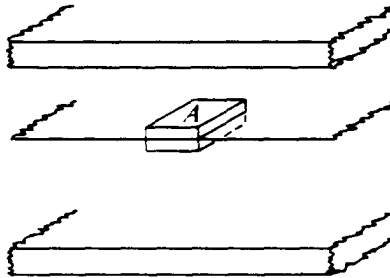

- By applying Gauss's law to an appropriately chosen Gaussian surface, show that the sum of the induced charge densities, σ_1 and σ_2 , on the inner surfaces of the conducting plates equals $-\sigma$. Indicate clearly on the diagram below, the Gaussian surface you used.

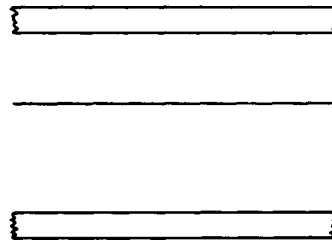

- Develop an expression for the potential difference V between the charged sheet and the conducting plates in terms of σ , a , b , and any appropriate fundamental constants.

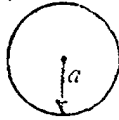

1988E1. The isolated conducting solid sphere of radius a shown above is charged to a potential V .

- a. Determine the charge on the sphere.

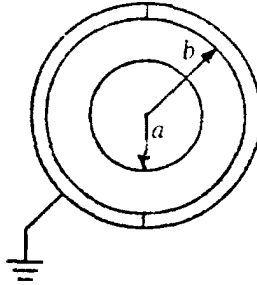

Two conducting hemispherical shells of inner radius b are then brought up and, without contacting the solid sphere are connected to form a spherical shell surrounding and concentric with the solid sphere as shown below. The outer shell is then grounded.

- b. By means of Gauss's law, determine the electric field in the space between the solid sphere and the shell at a distance r from the center.
 c. Determine the potential of the solid sphere relative to ground.
 d. Determine the capacitance of the system in terms of the given quantities and fundamental constants.
-

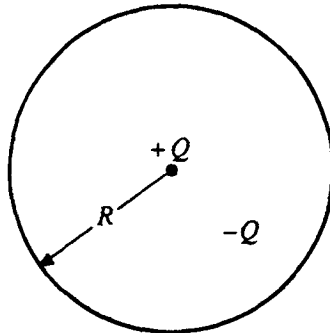

1989E1. A negative charge $-Q$ is uniformly distributed throughout the spherical volume of radius R shown above. A positive point charge $+Q$ is at the center of the sphere. Determine each of the following in terms of the quantities given and fundamental constants.

- a. The electric field E outside the sphere at a distance $r > R$ from the center
 b. The electric potential V outside the sphere at a distance $r > R$ from the center
 c. The electric field inside the sphere at a distance $r < R$ from the center
 d. The electric potential inside the sphere at a distance $r < R$ from the center

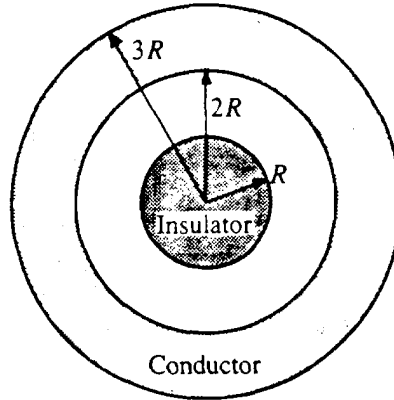

1990E1. A sphere of radius R is surrounded by a concentric spherical shell of inner radius $2R$ and outer radius $3R$, as shown above. The inner sphere is an insulator containing a net charge $+Q$ distributed uniformly throughout its volume. The spherical shell is a conductor containing a net charge $+q$ different from $+Q$.

Use Gauss's law to determine the electric field for the following values of r , the distance from the center of the insulator.

- $0 < r < R$
- $R < r < 2R$
- $2R < r < 3R$

Determine the surface charge density (charge per unit area) on

- the inside surface of the conducting shell;
- the outside surface of the conducting shell.

1992E1. A positive charge distribution exists within a nonconducting spherical region of radius a . The volume charge density ρ is not uniform but varies with the distance r from the center of the spherical charge distribution, according to the relationship $\rho = \beta r$ for $0 \leq r \leq a$, where β is a positive constant, and $\rho = 0$, for $r > a$.

- Show that the total charge Q in the spherical region of radius a is $\beta\pi a^4$
- In terms of β , r , a , and fundamental constants, determine the magnitude of the electric field at a point a distance r from the center of the spherical charge distribution for each of the following cases.
 - $r > a$
 - $r = a$
 - $0 < r < a$
- In terms of β , a , and fundamental constants, determine the electric potential at a point a distance r from the center of the spherical charge distribution for each of the following cases.
 - $r = a$
 - $r = 0$

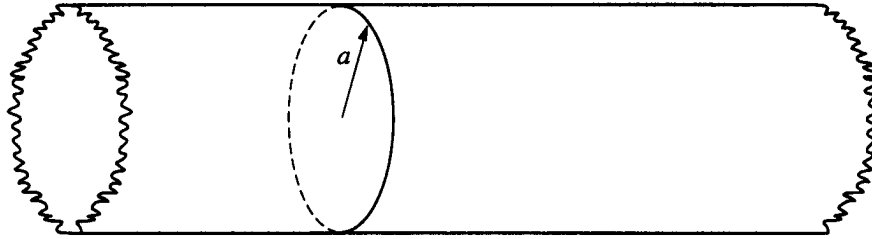

1995E1. A very long nonconducting rod of radius a has positive charge distributed throughout its volume. The charge distribution is cylindrically symmetric, and the total charge per unit length of the rod is λ .

- a. Use Gauss's law to derive an expression for the magnitude of the electric field E outside the rod.
- b. The diagrams below represent cross sections of the rod. On these diagrams, sketch the following.
 - i. Several equipotential lines in the region $r > a$

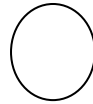

- ii. Several electric field lines in the region $r > a$

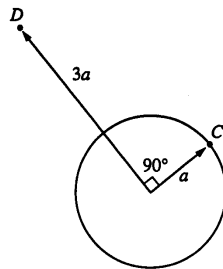
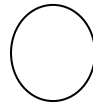

- c. In the diagram above, point C is a distance a from the center of the rod (i.e., on the rod's surface), and point D is a distance $3a$ from the center on a radius that is 90° from point C . Determine the following.
 - i. The potential difference $V_C - V_D$ between points C and D
 - ii. The work required by an external agent to move a charge $+Q$ from rest at point D to rest at point C

Inside the rod ($r < a$), the charge density ρ is a function of radial distance r from the axis of the rod and is given by $\rho = \rho_0(r/a)^{1/2}$, where ρ_0 is a constant.

- d. Determine the magnitude of the electric field E as a function of r for $r < a$. Express your answer in terms of ρ_0 , a , and fundamental constants.

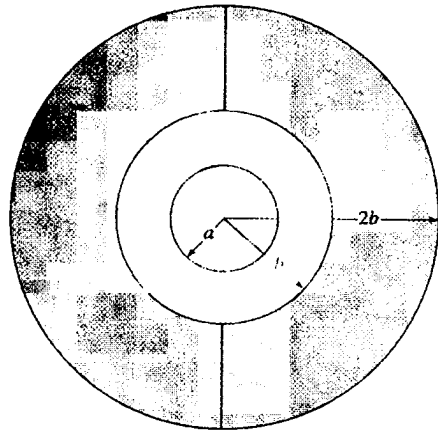

- 1996E1. A solid metal sphere of radius a is charged to a potential $V_o > 0$ and then isolated from the charging source. It is then surrounded by joining two uncharged metal hemispherical shells of inner radius b and outer radius $2b$, as shown above, without touching the inner sphere or any source of charge.
- In terms of the given quantities and fundamental constants, determine the initial charge Q_o on the solid sphere before it was surrounded by the outer shell.
 - Indicate the induced charge on the following after the outer shell is in place.
 - The inner surface of the shell
 - The outer surface of the shell
 - Indicate the magnitude of the electric field as a function of r and the direction (if any) of the field for the regions indicated below. Write your answers on the appropriate lines.

i. $r < a$	Magnitude _____	Direction _____
ii. $a < r < b$	Magnitude _____	Direction _____
iii. $b < r < 2b$	Magnitude _____	Direction _____
iv. $2b < r$	Magnitude _____	Direction _____
 - Does the inner sphere exert a force on the uncharged hemispheres while the shell is being assembled? Why or why not?
 - Although the charge on the inner solid sphere has not changed, its potential has. In terms of V_o , a , and b , determine the new potential on the inner sphere. Be sure to show your work.

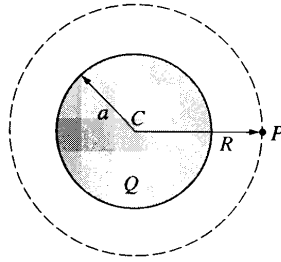

1997E2. A nonconducting sphere with center C and radius a has a spherically symmetric electric charge density. The total charge of the object is $Q > 0$.

- Determine the magnitude and direction of the electric field at point P , which is a distance $R > a$ to the right of the sphere's center.
- Determine the flux of the electric field through the spherical surface centered at C and passing through P .

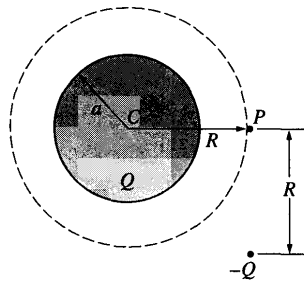

A point particle of charge $-Q$ is now placed a distance R below point P , as shown above.

- Determine the magnitude and direction of the electric field at point P .

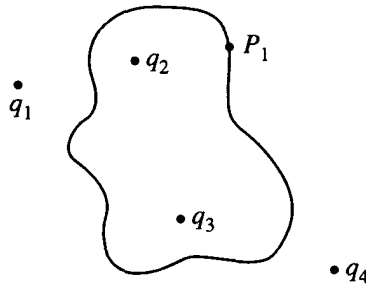

- Now consider four point charges, q_1 , q_2 , q_3 , and q_4 , that lie in the plane of the page as shown in the diagram above. Imagine a three-dimensional closed surface whose cross section in the plane of the page is indicated.
 - Which of these charges contribute to the net electric flux through the surface?
 - Which of these charges contribute to the electric field at point P_1 ?
 - Are your answers to i and ii the same or are they different? Explain why this is so.
- If the net charge enclosed by a surface is zero, does this mean that the field is zero at all points on the surface? Justify your answer.
- If the field is zero at all points on a surface, does this mean there is no net charge enclosed by the surface? Justify your answer.

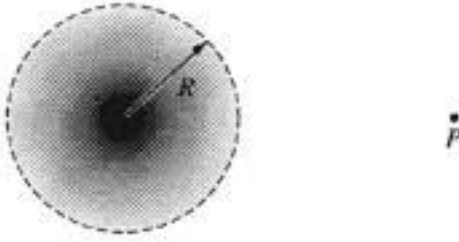

2003E1. A spherical cloud of charge of radius R contains a total charge $+Q$ with a nonuniform volume charge density that varies according to the equation

$$\rho(r) = \rho_0(1 - r/R) \text{ for } r \leq R \text{ and}$$

$$\rho = 0 \text{ for } r > R,$$

where r is the distance from the center of the cloud. Express all algebraic answers in terms of Q , R , and fundamental constants.

- a. Determine the following as a function of r for $r > R$.
 - i. The magnitude E of the electric field
 - ii. The electric potential V
- b. A proton is placed at point P shown above and released. Describe its motion for a long time after its release.
- c. An electron of charge magnitude e is now placed at point P , which is a distance r from the center of the sphere, and released. Determine the kinetic energy of the electron as a function of r as it strikes the cloud.
- d. Derive an expression for ρ_0 .
- e. Determine the magnitude E of the electric field as a function of r for $r \leq R$.

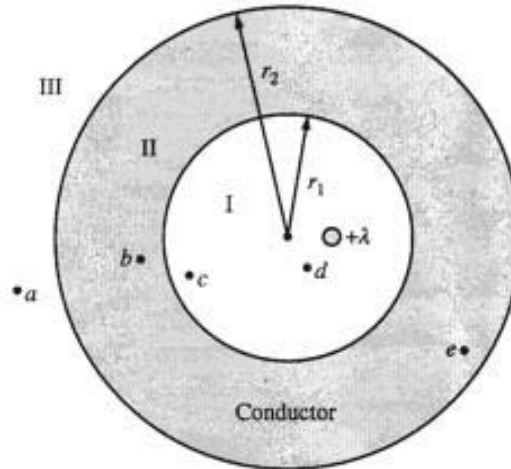
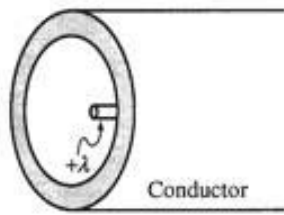

Cross Section

2004E1. The figure above left shows a hollow, infinite, cylindrical, uncharged conducting shell of inner radius r_1 and outer radius r_2 . An infinite line charge of linear charge density $+\lambda$ is parallel to its axis but off center. An enlarged cross section of the cylindrical shell is shown above right.

- On the cross section above right,
 - sketch the electric field lines, if any, in each of regions I, II, and III and
 - use + and - signs to indicate any charge induced on the conductor.
- In the spaces below, rank the electric potentials at points a , b , c , d , and e from highest to lowest (1 = highest potential). If two points are at the same potential, give them the same number.

- _____ V_a
 _____ V_b
 _____ V_c
 _____ V_d
 _____ V_e

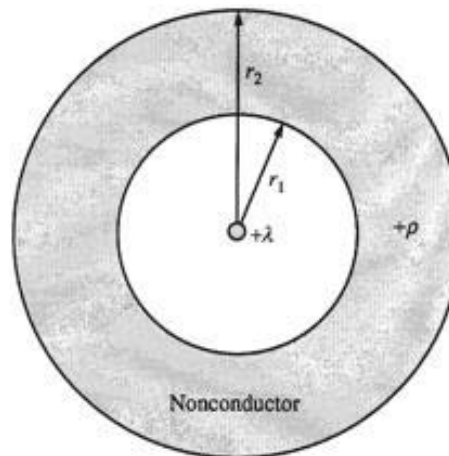
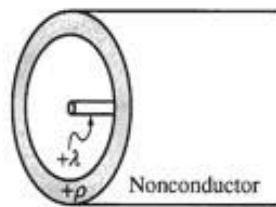

Cross Section

- The shell is replaced by another cylindrical shell that has the same dimensions but is nonconducting and carries a uniform volume charge density $+\rho$. The infinite line charge, still of charge density $+\lambda$, is located at the center of the shell as shown above. Using Gauss's law, calculate the magnitude of the electric field as a function of the distance r from the center of the shell for each of the following regions. Express your answers in terms of the given quantities and fundamental constants.
 - $r < r_1$
 - $r_1 \leq r \leq r_2$
 - $r > r_2$

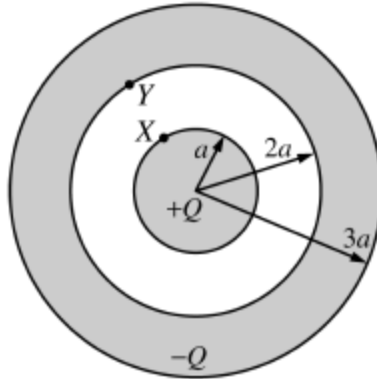

2007E2. In the figure above, a nonconducting solid sphere of radius a with charge $+Q$ uniformly distributed throughout its volume is concentric with a nonconducting spherical shell of inner radius $2a$ and outer radius $3a$ that has a charge $-Q$ uniformly distributed throughout its volume. Express all answers in terms of the given quantities and fundamental constants.

- (a) Using Gauss's law, derive expressions for the magnitude of the electric field as a function of radius r in the following regions.
- Within the solid sphere ($r < a$)
 - Between the solid sphere and the spherical shell ($a < r < 2a$)
 - Within the spherical shell ($2a < r < 3a$)
 - Outside the spherical shell ($r > 3a$)
- (b) What is the electric potential at the outer surface of the spherical shell ($r = 3a$)? Explain your reasoning.
- (c) Derive an expression for the electric potential difference $V_x - V_y$ between points X and Y shown in the figure.

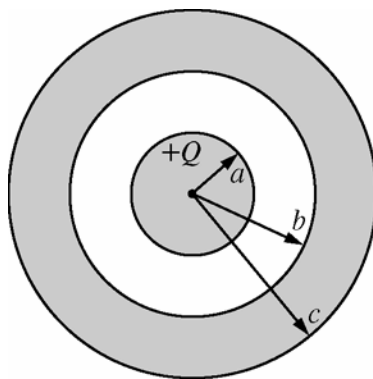

2008E1. A metal sphere of radius a contains a charge $+Q$ and is surrounded by an uncharged, concentric, metallic shell of inner radius b and outer radius c , as shown above. Express all algebraic answers in terms of the given quantities and fundamental constants.

(a) Determine the induced charge on each of the following and explain your reasoning in each case.

- i. The inner surface of the metallic shell
- ii. The outer surface of the metallic shell

(b) Determine expressions for the magnitude of the electric field E as a function of r , the distance from the center of the inner sphere, in each of the following regions.

- i. $r < a$
- ii. $a < r < b$
- iii. $b < r < c$
- iv. $r > c$

(c) On the axes below, sketch a graph of E as a function of r .

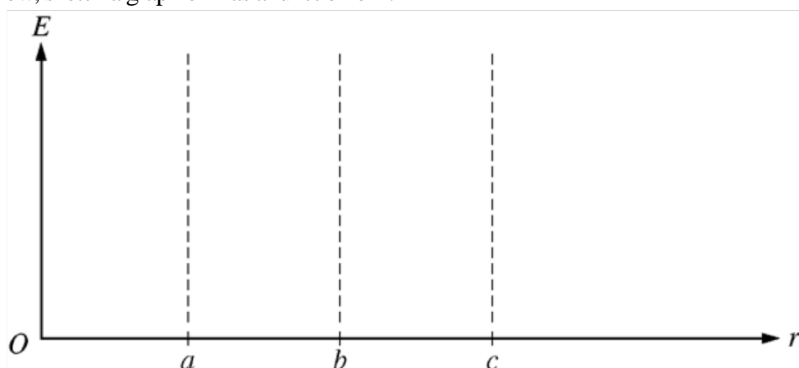

(d) An electron of mass m_e carrying a charge $-e$ is released from rest at a very large distance from the spheres. Derive an expression for the speed of the particle at a distance $10c$ from the center of the spheres.

2011E1.

A nonconducting, thin, spherical shell has a uniform surface charge density σ on its outside surface and no charge anywhere else inside.

- (a) Use Gauss's law to prove that the electric field inside the shell is zero everywhere. Describe the Gaussian surface that you use.
- (b) The charges are now redistributed so that the surface charge density is no longer uniform. Is the electric field still zero everywhere inside the shell?
___ Yes ___ No ___ It cannot be determined from the information given.
Justify your answer.

Now consider a small conducting sphere with charge $+Q$ whose center is at corner A of a cubical surface, as shown below.

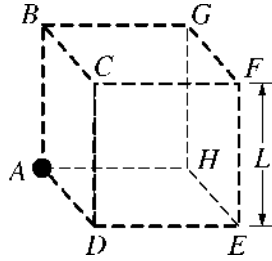

- (c) For which faces of the surface, if any, is the electric flux through that face equal to zero?
___ $ABCD$ ___ $CDEF$ ___ $EFGH$ ___ $ABGH$ ___ $BCFG$ ___ $ADEH$
Explain your reasoning.
- (d) At which corner(s) of the surface does the electric field have the least magnitude?
- (e) Determine the electric field strength at the position(s) you have indicated in part (d) in terms of Q , L , and fundamental constants, as appropriate.
- (f) Given that one-eighth of the sphere at point A is inside the surface, calculate the electric flux through face $CDEF$.

SECTION C – Electric Potential and Energy

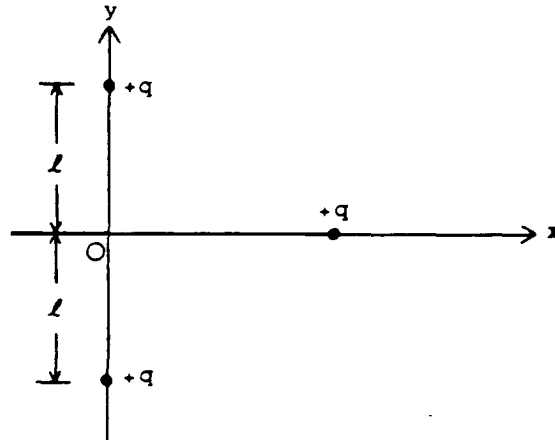

1975E1. Two stationary point charges $+q$ are located on the y -axis as shown above. A third charge $+q$ is brought in from infinity along the x -axis.

- Express the potential energy of the movable charge as a function of its position on the x -axis.
- Determine the magnitude and direction of the force acting on the movable charge when it is located at the position $x = l$
- Determine the work done by the electric field as the charge moves from infinity to the origin.

1977E1. A charge $+Q$ is uniformly distributed around a wire ring of radius R . Assume that the electric potential is zero at $x = \text{infinity}$, with the origin 0 of the x -axis at the center of the ring.

- What is the electric potential at a point P on the x -axis?
- Where along the x -axis is the electric potential the greatest? Justify your answer.
- What is the magnitude and direction of the electric field \mathbf{E} at point P ?
- On the axes below, make a sketch of \mathbf{E} as a function of the distance along the x -axis showing significant features.

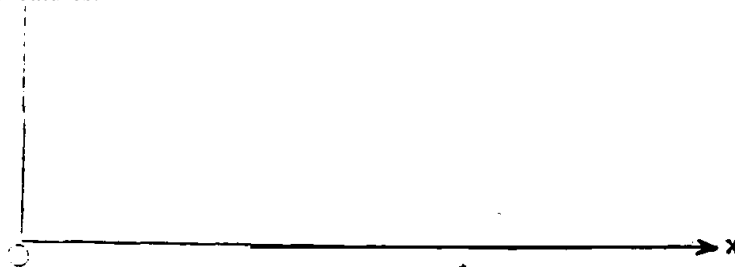

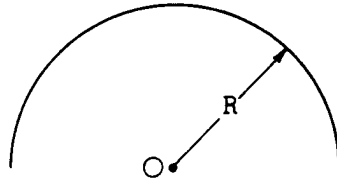

1980E1. A thin plastic rod has uniform linear positive-charge density λ . The rod is bent into a semicircle of radius R as shown above.

- Determine the electric potential V_o at point O, the center of the semicircle.
- Indicate on the diagram above the direction of the electric field at point O. Explain your reasoning.
- Calculate the magnitude E_o of the electric field at point O.

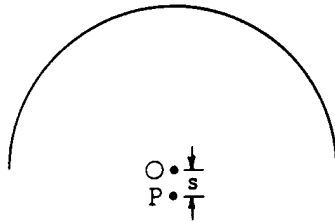

- Write an approximate expression, in terms of q , V_o , and E_o , for the work required to bring a positive point charge q from infinity to point P, located a small distance s from point O as shown in the diagram above.

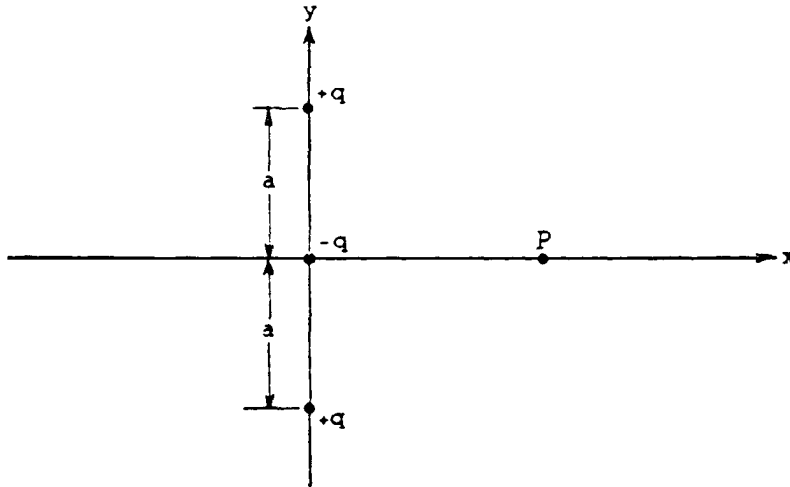

1982E1. Three point charges are arranged on the y-axis as shown above. The charges are $+q$ at $(0, a)$, $-q$ at $(0, 0)$, and $+q$ at $(0, -a)$. Any other charge or material is infinitely far away.

- Determine the point(s) on the x-axis where the electric potential due to this system of charges is zero.
- Determine the x and y components of the electric field at a point P on the x-axis at a distance x from the origin.
- Using Gauss's law, determine the net electric flux through a spherical surface of radius $r = 2a$ centered at the origin.

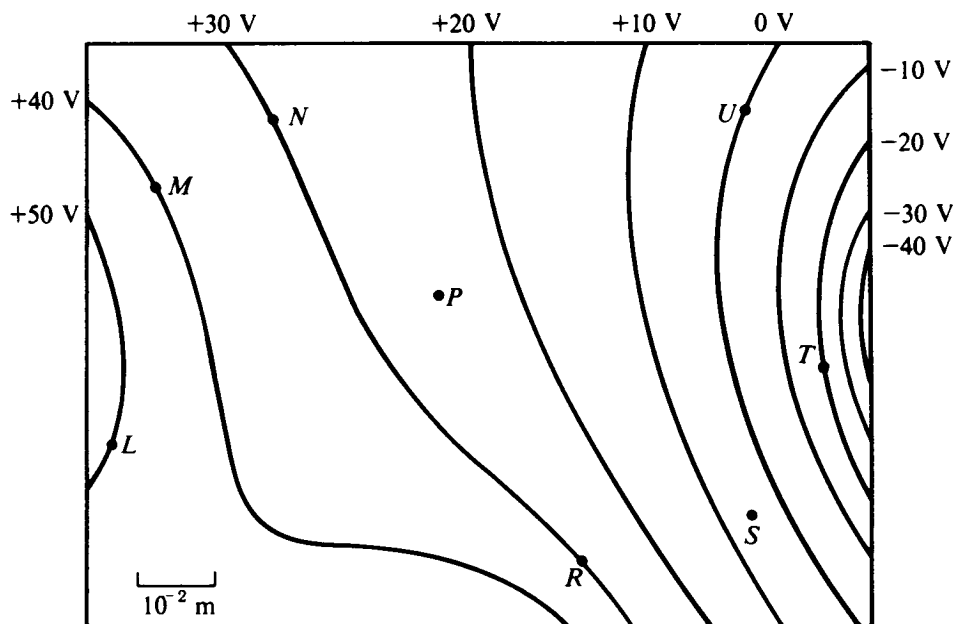

- 1986E1. Three point charges produce the electric equipotential lines shown on the diagram above.
- Draw arrows at points L, N, and U on the diagram to indicate the direction of the electric field at these points.
 - At which of the lettered points is the electric field E greatest in magnitude? Explain your reasoning.
 - Compute an approximate value for the magnitude of the electric field E at point P.
 - Compute an approximate value for the potential difference, $V_M - V_S$, between points M and S.
 - Determine the work done by the field if a charge of $+5 \times 10^{-12}$ coulomb is moved from point M to point R.
 - If the charge of $+5 \times 10^{-12}$ coulomb were moved from point M first to point S, and then to point R, would the answer to (e) be different, and if so, how?

- 1987E1. A total charge Q is distributed uniformly throughout a spherical volume of radius R . Let r denote the distance of a point from the center of the sphere of charge. Use Gauss's law to derive an expression for the magnitude of the electric field at a point
- outside the sphere, $r > R$;
 - inside the sphere, $r < R$.

The electrostatic potential is assumed to be zero at an infinite distance from the sphere.

- What is the potential at the surface of the sphere?
- Determine the potential at the center of the sphere.

2000E2. Three particles, A, B, and C, have equal positive charges Q and are held in place at the vertices of an equilateral triangle with sides of length l , as shown in the figures below. The dotted lines represent the bisectors for each side. The base of the triangle lies on the x -axis, and the altitude of the triangle lies on the y -axis.

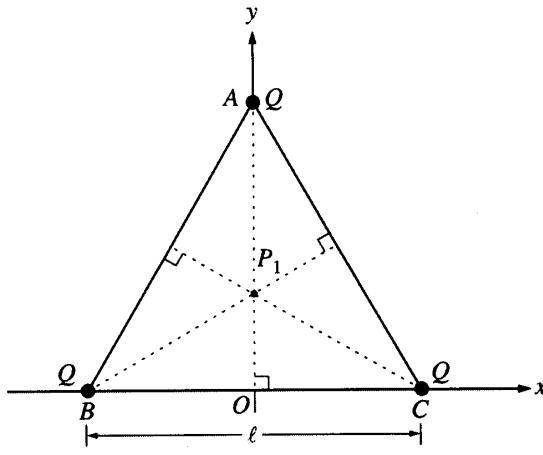

Figure 1

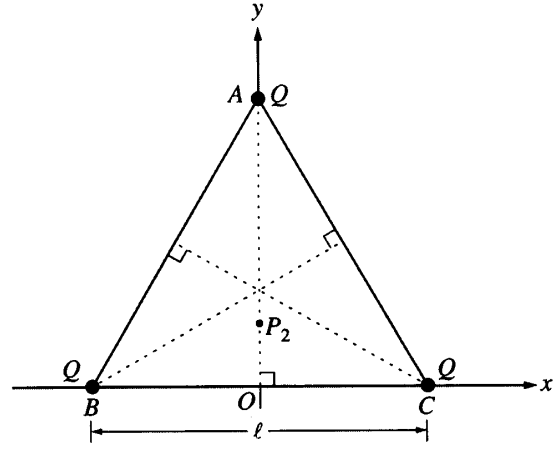
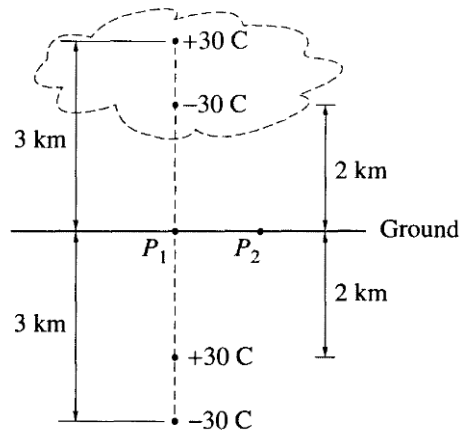
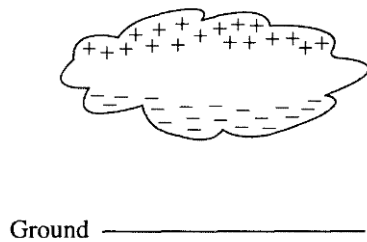

Figure 2

- a.
- i. Point P_1 , the intersection of the three bisectors, locates the geometric center of the triangle and is one point where the electric field is zero. On Figure 1 above, draw the electric field vectors E_A , E_B , and E_C at P_1 , due to each of the three charges. Be sure your arrows are drawn to reflect the relative magnitude of the fields.
 - ii. Another point where the electric field is zero is point P_2 at $(0, y_2)$. On Figure 2 above, draw electric field vectors E_A , E_B , and E_C at P_2 due to each of the three point charges. Indicate below whether the magnitude of each of these vectors is greater than, less than, or the same as for point P_1 .

	Greater than at P_1	Less than at P_1	The same as at P_1
E_A			
E_B			
E_C			

- b. Explain why the x -component of the total electric field is zero at any point on the y -axis.
- c. Write a general expression for the electric potential V at any point on the y -axis inside the triangle in terms of Q , l , and y .
- d. Describe how the answer to part (c) could be used to determine the y -coordinates of points P_1 and P_2 at which the electric field is zero. (You do not need to actually determine these coordinates.)



Note: Figures not drawn to scale.

2001E1. A thundercloud has the charge distribution illustrated above left. Treat this distribution as two point charges, a negative charge of -30 C at a height of 2 km above ground and a positive charge of $+30\text{ C}$ at a height of 3 km . The presence of these charges induces charges on the ground. Assuming the ground is a conductor, it can be shown that the induced charges can be treated as a charge of $+30\text{ C}$ at a depth of 2 km below ground and a charge of -30 C at a depth of 3 km , as shown above right. Consider point P_1 , which is just above the ground directly below the thundercloud, and point P_2 , which is 1 km horizontally away from P_1 .

- a. Determine the direction and magnitude of the electric field at point P_1 .
- b.
 - i. On the diagram on the previous page, clearly indicate the direction of the electric field at point P_2
 - ii. How does the magnitude of the field at this point compare with the magnitude at point P_1 ? Justify your answer:

_____ Greater _____ Equal _____ Less

- c. Letting the zero of potential be at infinity, determine the potential at these points.
 - i. Point P_1
 - ii. Point P_2
- d. Determine the electric potential at an altitude of 1 km directly above point P_1 .
- e. Determine the total electric potential energy of this arrangement of charges.

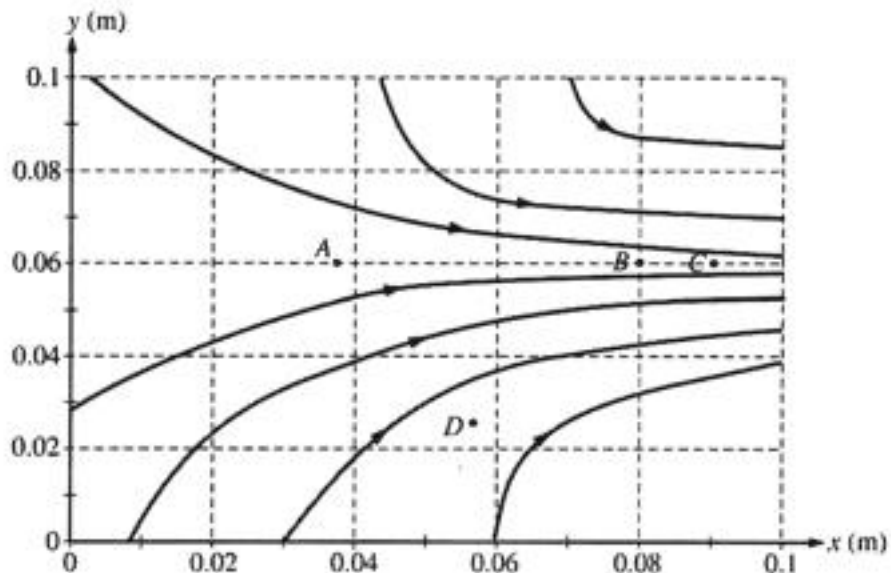

2005E1. Consider the electric field diagram above.

- Points A , B , and C are all located at $y = 0.06$ m.
 - At which of these three points is the magnitude of the electric field the greatest? Justify your answer.
 - At which of these three points is the electric potential the greatest? Justify your answer.
- An electron is released from rest at point B .
 - Qualitatively describe the electron's motion in terms of direction, speed, and acceleration.
 - Calculate the electron's speed after it has moved through a potential difference of 10 V.
- Points B and C are separated by a potential difference of 20 V. Estimate the magnitude of the electric field midway between them and state any assumptions that you make.
- On the diagram, draw an equipotential line that passes through point D and intersects at least three electric field lines.

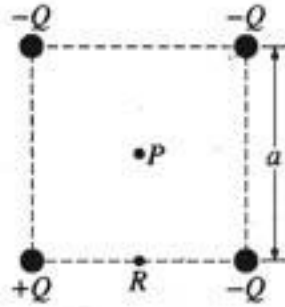

2006E1. The square of side a above contains a positive point charge $+Q$ fixed at the lower left corner and negative point charges $-Q$ fixed at the other three corners of the square. Point P is located at the center of the square.

- a. On the diagram, indicate with an arrow the direction of the net electric field at point P .
- b. Derive expressions for each of the following in terms of the given quantities and fundamental constants.
 - i. The magnitude of the electric field at point P
 - ii. The electric potential at point P
- c. A positive charge is placed at point P . It is then moved from point P to point R , which is at the midpoint of the bottom side of the square. As the charge is moved, is the work done on it by the electric field positive, negative, or zero?

_____ Positive _____ Negative _____ Zero

Explain your reasoning.

- d.
 - i. Describe one way to replace a single charge in this configuration that would make the electric field at the center of the square equal to zero. Justify your answer.
 - ii. Describe one way to replace a single charge in this configuration such that the electric potential at the center of the square is zero but the electric field is not zero. Justify your answer.

2009E1.

A spherically symmetric charge distribution has net positive charge Q_0 distributed within a radius of R . Its electric potential V as a function of the distance r from the center of the sphere is given by the following.

$$V(r) = \frac{Q}{4\pi\epsilon_0 R} \left[-2 + 3\left(\frac{r}{R}\right)^2 \right] \text{ for } r < R$$
$$V(r) = \frac{Q}{4\pi\epsilon_0 r} \text{ for } r > R$$

Express all algebraic answers in terms of the given quantities and fundamental constants.

- (a) For the following regions, indicate the direction of the electric field $E(r)$ and derive an expression for its magnitude.
- i. $r < R$
____ Radially inward ____ Radially outward
- ii. $r > R$
____ Radially inward ____ Radially outward
- (b) For the following regions, derive an expression for the enclosed charge that generates the electric field in that region, expressed as a function of r .
- i. $r < R$
- ii. $r > R$
- (c) Is there any charge on the surface of the sphere ($r = R$)?
____ Yes ____ No
If there is, determine the charge. In either case, explain your reasoning.
- (d) On the axes below, sketch a graph of the force that would act on a positive test charge in the regions $r < R$ and $r > R$. Assume that a force directed radially outward is positive.

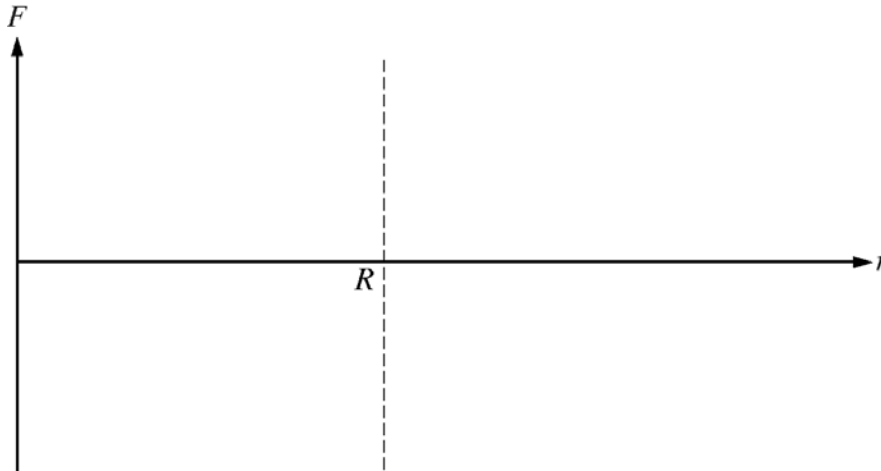

SECTION D – Capacitance

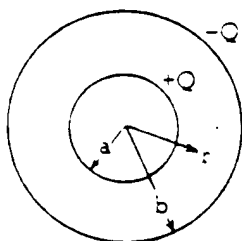

1978E3. A capacitor is composed of two concentric spherical shells of radii a and b , respectively, that have equal and opposite charges as shown above. Just outside the surface of the inner shell, the electric field is directed radially outward and has magnitude E_o .

- With the use of Gauss's law, express the charge $+Q$ on the inner shell as a function of E_o and a .
- Write an expression for the electric field strength E between the shells as a function of E_o , a , and r .
- What is the potential difference V between the shells as a function of E_o , a , and b ?
- Express the energy U stored in this capacitor as a function of E_o , a , and b .
- Determine the value of a that should be chosen in order to maximize U , if E_o and b are fixed.

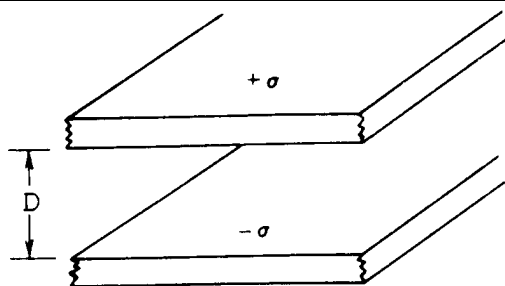

1980E2. A parallel-plate capacitor consists of two conducting plates separated by a distance D as shown above. The plates may be considered very large so that the effects of the edges may be ignored. The two plates have an equal but opposite surface charge per unit area, σ . The charge on either plate resides entirely on the inner surface facing the opposite plate.

- On the diagram below draw the electric field lines in the region between the plates.

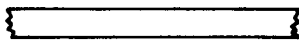

- By applying Gauss's law to the rectangular box whose upper surface lies entirely within the top conducting plate, as shown in the following diagram, determine the magnitude of the electric field E in the region between the plates.

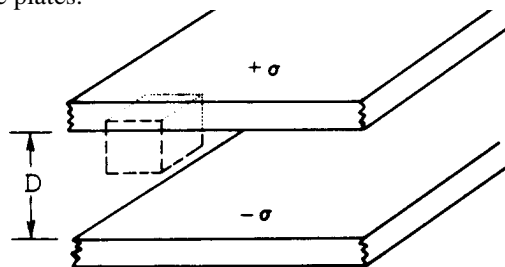

- A dielectric is inserted and fills the region between the plates. Is the electric field greater than, less than, or equal to the electric field when there is no dielectric? Describe the mechanism responsible for this effect. Recognize that the plates are not connected to a battery.

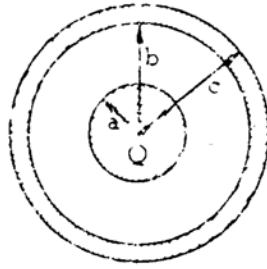

1981E1. A conducting sphere of radius a and charge Q is surrounded by a concentric conducting shell of inner radius b and outer radius c as shown above. The outer shell is first grounded; then the grounding wire is removed.

- Using Gauss's law, determine the electric field in the region $a < r < b$, where r is the distance from the center of the inner sphere.
- Develop an expression for the capacitance C_0 of the system of the two spheres. A liquid dielectric with a dielectric constant of 4 is then inserted in the space between the conducting spheres and the shell, filling half of the space as shown below.

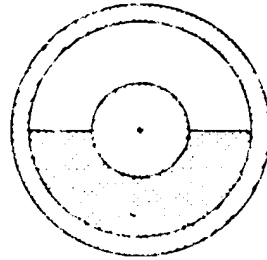

- Determine the capacitance C of the system in terms of C_0 .
-

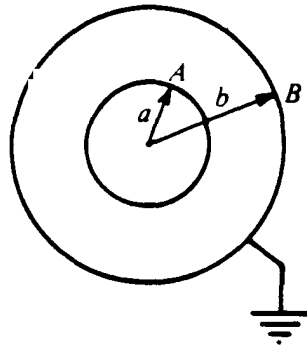

1983E1. Two concentric, conducting spherical shells, A and B, have radii a and b , respectively, ($a < b$). Shell B is grounded, whereas shell A is maintained at a positive potential V_0 .

- Using Gauss's law, develop an expression for the magnitude E of the electric field at a distance r from the center of the shells in the region between the shells. Express your answer in terms of the charge Q on the inner shell.
- By evaluating an appropriate integral, develop an expression for the potential V_0 in terms of Q , a , and b .
- Develop an expression for the capacitance of the system in terms of a and b .

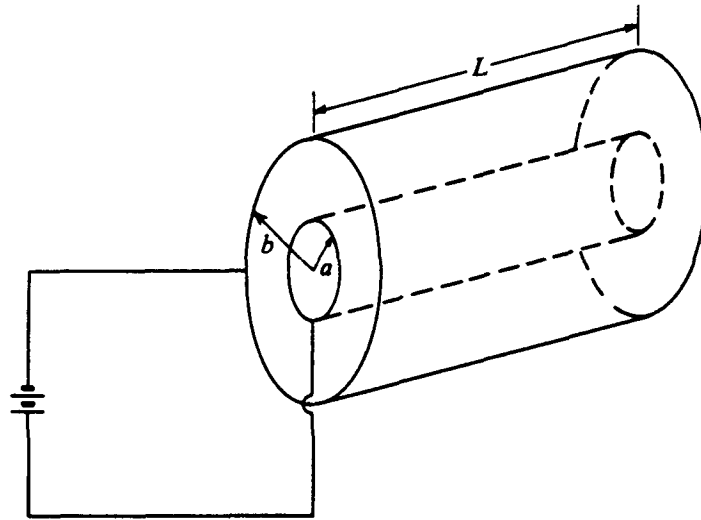

1985E1. A capacitor consisting of conducting coaxial cylinders of radii a and b , respectively, and length L is connected to a source of emf, as shown above. When the capacitor is charged, the inner cylinder has a charge $+Q$ on it. Neglect end effects and assume that the region between the cylinders is filled with air. Express your answers in terms of the given quantities.

- Use Gauss's law to determine an expression for the electric field at a distance r from the axis of the cylinder where $a < r < b$.
- Determine the potential difference between the cylinders.
- Determine the capacitance C_0 of the capacitor.

One third of the length of the capacitor is then filled with a dielectric of dielectric constant $k = 2$, as shown in the following diagram.

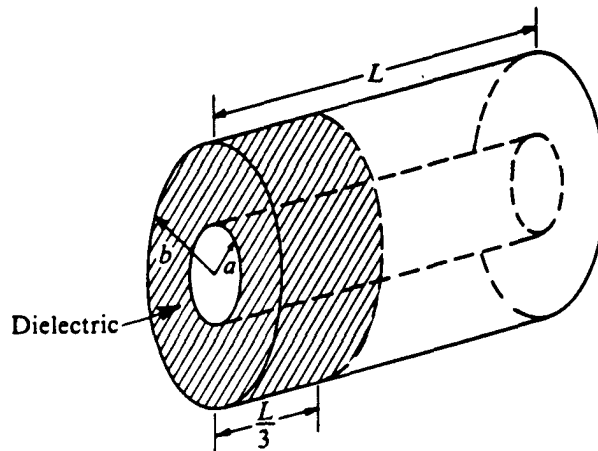

- Determine the new capacitance C in terms of C_0 .

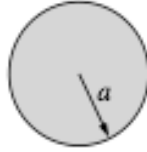

1999E1. An isolated conducting sphere of radius $a = 0.20$ m is at a potential of $-2,000$ V.

- a. Determine the charge Q_0 on the sphere.

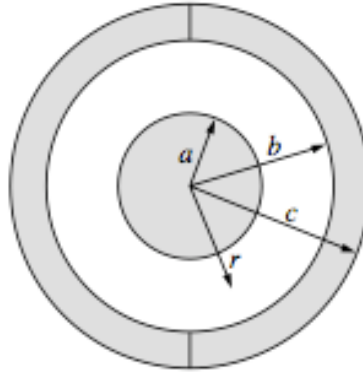

The charged sphere is then concentrically surrounded by two uncharged conducting hemispheres of inner radius $b = 0.40$ m and outer radius $c = 0.50$ m, which are joined together as shown above, forming a spherical capacitor. A wire is connected from the outer sphere to ground, and then removed.

- b. Determine the magnitude of the electric field in the following regions as a function of the distance r from the center of the inner sphere.
- $r < a$
 - $a < r < b$
 - $b < r < c$
 - $r > c$
- c. Determine the magnitude of the potential difference between the sphere and the conducting shell.
- d. Determine the capacitance of the spherical capacitor.

SECTION A – Coulomb’s Law and Coulomb’s Law Methods

<u>Solution</u>	<u>Answer</u>
1. Outside a point charge $E = kQ/r^2$	C
2. The electric field due to +Q point to the right along the x axis, for an opposing field (pointing to the left along the x axis) we need a negative charge to the left of point P. Since the magnitude of the negative charge is larger, it needs to be farther away for the field from the negative charge to have the same magnitude as the field from the positive charge.	C
3. E fields cancel from the two charges at the midpoint	A
4. The force on the bottom is to the right, the force on the top is to the left and larger. There is a non-zero net force and a net torque.	B
5. The force is proportional to the product of the charges. Before touching, this product is $2Q^2$. After touching and separating, the new charges are $(+2Q - Q)/2 = Q/2$. The new force is proportional to the new product $(Q/2)^2 = Q^2/4$, one-eighth of the original product	E
6. F is proportional to $q \times q/d^2$	E
7. $\mathbf{F} = \mathbf{E}q$, no relevance to velocity	D
8. Electric field lines point away from + charges and toward – charges. Symmetry is required for the fields to cancel at the center	A
9. Electric field lines point away from + charges and toward – charges. Construct each field vector	C
10. At the center of the ring, the field is zero due to symmetry/cancellation. Only choice B has this feature.	B
11. $\mathbf{E} = \mathbf{F}/q$, without knowing the force, you cannot know the charge	C
12. From symmetry, the electron will be attracted to the center of the positive piece and repelled from the center of the negative piece	B
13. $E = kQ/r^2$	E
14. Negative charges in sphere X are driven into sphere Y	D
15. Negative charges in sphere 1 are driven into sphere 2	C
16. The test charge is repelled to the left and down	E
17. Each force is equal and they are at right angles (Pythagorean theorem)	D
18. If there is a single force on an object, it must be accelerating. Negative charges experience forces opposite the direction of electric field lines.	A
19. $E = 0$ at the midpoint and is large near each of the charges, growing to infinity as the charge is approached	A
20. E points directly away from the positive charge and toward the (larger) negative charge	E
21. To be zero, the point must be closer to the smaller magnitude of charge (left of the origin) and where the vectors point in opposite directions (outside the charges – to the left of Q). Since the negative charge is 4 times greater, the point must be twice as far from the -4Q than from the Q.	A
22. Charge separation in I, Charging by induction in III (opposite charge of the rod)	D

SECTION B – Gauss’s Law

23. The field from an infinite sheet of charge is uniform and, in this case, equal in magnitude, pointing away from the sheet on the left and toward the sheet on the right. The E field cancels outside the sheets. E
24. The arrangement of the field lines inside will change as the charge is moved as it is due to that charge. Outside the sphere, the induced surface charge is evenly distributed around the outer surface. B
25. By definition. A
26. No net charge is enclosed B
27. Linear (proportional to r) inside, proportional to $1/r^2$ outside C
28. If four lines is proportional to +Q, then 8 inward pointing lines is proportional to -2Q. This would be the *net* charge enclosed E
29. By Gauss’s Law, the flux is proportional to the net charge enclosed E
30. Left side: $EA = E(4\pi r^2)$ (area of the Gaussian surface) Right side: Q enclosed = fraction of Q inside = $Q \times (\text{volume of Gaussian surface} / \text{volume of sphere})$ D
31. The charge +Q induces a charge -Q on the inner surface of the box, inducing a charge +Q on the outer surface A
32. Gauss’s Law needs some symmetry and regularity to the electric field for a convenient Gaussian surface to be drawn and used. C
33. E fields from external charges will not permeate into a conductor A
34. Linear (proportional to r) inside, proportional to $1/r^2$ outside D

SECTION C – Electric Potential and Energy

35. By definition E
36. $V = \Sigma kQ/r$, positive and approaching infinity as it nears the positive charge and negative and approaching negative infinity near the negative charge. Since the positive charge is larger, the zero point is closer to the smaller charge. D
37. For potential to be zero, we need two positive and two negative charges. For the electric field to be zero, we need symmetry about the origin to cancel the fields. E
38. With all positive charges, the potential can never be zero at the origin, while the symmetry allows the electric fields to cancel D
39. The field from an infinite sheet of charge is uniform and, in this case, equal in magnitude, pointing away from the sheet on the left and toward the sheet on the right. The E field cancels outside the sheets. With $E = 0$, the potential is uniform outside the sheets, positive on the left and negative on the right, with a linear transition between as E is uniform. B
40. $E = 0$ inside a conductor, which means V is constant. Outside the sphere, V varies as $1/r$ A
41. $W_{\text{field}} = -q\Delta V$ D

42. When charged conductors are connected, charge flows when there is a difference in potential, until there is no longer a difference in potential. A
43. $V = \Sigma kQ/r$, with the symmetry $V_R = V_S$. $W = q\Delta V = 0$ D
44. $V = \Sigma kQ/r$, point A represents the largest sum of Q/r for the two charges A
45. Outside the spheres $E = 0$ so V is constant (and zero relative to infinity). Once inside the negative shell, the potential is that for a positively charged conducting sphere (constant inside, proportional to $1/r$ outside) D
46. $E = 0$ in and on conductors which means V is constant throughout E
47. $W = q\Delta V = qEd$ A
48. $V = kQ/r$ so the smaller sphere is at a higher potential. Current flows from higher to lower potential. B
49. For a spherical shell of charge, $E = 0$ inside, which means V is constant, equal to its value on the surface A
50. Standard spherical charge distribution formulae D
51. $V = \Sigma kQ/r$, every point on the ring is equidistant from any given point on the x axis so $V = kQ/r$, where r is the distance from a point on the ring to a point on the x axis (Pythagorean theorem) B
52. $V = \Sigma kQ/r$ and all are positive so they all add. The electric field vectors cancel. D
53. There is a locus of points around $+Q$ that satisfy the condition $k(-2Q)/r_1 + k(+Q)/r_2 = 0$. On the x axis, one is at point P, the other is between the charges (and closer to the smaller charge) D
54. $E = -dV/dr$ E
55. From the spherical symmetry, the electric field between the shells is only dependent on the inside shell. A
56. Relative to infinity, on the outer surface of the larger shell, the potential is $k(Q_1 + Q_2)/r_2$. Once inside there is no more change to the potential due to Q_2 , but still varies as $1/r$ due to Q_1 until the final position is reached. E
57. The potential difference between the plates is $4V$, this can be produced with two $2V$ batteries in series (note the positive plate is on the left) D
58. Electrons are forced from low potential toward high potential. The electric field strength is necessary to know the magnitude. D
59. The incremental amount of work required to bring a small amount of charge dq is $dW = V(dq)$ where V is the potential relative to infinity at that time, which is kq/R (q being the amount of charge currently on the sphere) C
60. E is zero closer to the smaller charge and where the vectors will point in opposite directions C
61. $V = \Sigma kQ/r$, with no negative charges in the vicinity, V can never be zero E
62. E is proportional to the gradient of V , in this case, the slope. F is largest where E is largest which is where the greatest slope occurs. D
63. $\Delta V = W/q$ (distance is not needed) C
64. $F = ke^2/R^2 = mv^2/R$ and $K = \frac{1}{2} mv^2$ ($K > 0$) B
65. $E = -dV/dr$ C

66. Since $E = -dV/dr = -2kr$ the field points toward the origin and electrons experience forces opposite in direction to electric fields B
67. With no work done by the field, the charge must be moving along an equipotential, which is perpendicular to E fields. $W = -q\Delta V$ with $\Delta V = 0$ D
68. No work is required to move the charge inside the sphere so the only work done is to move the charge to the surface. $W = q\Delta V = q(V_R - V_r)$ where $V_R = kQ/R$ and $V_r = kQ/r$ E
69. $V = -\int_0^{0.5} \mathbf{E} \cdot d\mathbf{x}$ B
70. (misplaced question) $U_C = \frac{1}{2} CV^2$ B
71. $q\Delta V = \frac{1}{2} mv^2$ C
72. The magnitude of E is the slope of the graph, which is zero for $r < R$ and since V is proportional to $1/r$ for $r > R$, then E is proportional to $1/r^2$ for $r > R$ C
73. Due to symmetry, all fields cancel A
74. The potential at the center is $V = \Sigma kQ/R = 6kQ/R$ and $W = Q\Delta V$ D
75. E points from high to low potential and E lines are perpendicular to equipotential lines A
76. E has the greatest magnitude where V has the largest gradient (the lines are closest) B
77. $W = q\Delta V$ B
78. For charge to be distributed throughout an object, it must not be a conductor, otherwise the charge would move to the surface of the object E

SECTION D – Capacitance

79. Once disconnected and isolated, the charge on the capacitor remains constant. Doubling the plate separation halves the capacitance ($C \propto 1/d$). $V = Q/C$ and $U_C = Q^2/2C$ or $1/2 QV$ D
80. $C \propto A/d$ C
81. In series $C_{\text{total}} = (\Sigma(1/C))^{-1}$. For N identical capacitors in series $C_{\text{total}} = C/N$ B
82. Each capacitor has 2 volts across it. $U_C = 1/2 CV^2$ C
83. An isolated capacitor has constant charge. Adding a dielectric increases the capacitance and $V = Q/C$ B
84. Like resistors in parallel, the mathematics dictate that the total is less than the smallest capacitance D
85. From Gauss's Law: $E \propto \sigma$ for a sheet of charge D
86. $C \propto A/d$ B
87. An isolated capacitor has constant charge. Adding a dielectric increases the capacitance and $V = Q/C$ B
88. Each of the three branches has an equivalent capacitance of $C_{\text{total}} = C/N = 2 \mu\text{F}/2 = 1 \mu\text{F}$. In parallel, the total capacitance is the sum of the individual capacitances (branches in this case) C
89. For a $2 \mu\text{F}$ capacitor to have a charge of $6 \mu\text{C}$ it needs a voltage of $V = Q/C = 3 \text{ V}$. Since each branch has two capacitors in series the branch should have a total voltage of 6 V C

90. $C \propto \kappa A/d$ where $\kappa_{\text{glass}} > 1$ E
91. $K = W = q\Delta V$ where $V = Q/C$ and $C \propto A/d$ A
92. The two capacitors in parallel have an equivalent capacitance of $6 \mu\text{F}$. In series with the $3 \mu\text{F}$, the total capacitance is $C_{\text{total}} = (C_1 \times C_2)/(C_1 + C_2)$ B
93. Between the set of two parallel capacitors with an equivalent capacitance of $6 \mu\text{F}$ and the $3 \mu\text{F}$ capacitor, the 12 V splits in the ratio of 1:2 (8 V and 4 V) with the larger voltage across the smaller capacitance D
94. $E = V/d$ B
95. $C \propto \kappa A/d$ where $\kappa > 1$ A
96. In series $C_{\text{total}} = (\Sigma(1/C))^{-1}$. For N identical capacitors in series $C_{\text{total}} = C/N$ E
97. $C \propto \kappa A/d$ D

SECTION A – Coulomb’s Law and Coulomb’s Law Methods**1991E1**

- a. From each charge $E = kQ/r^2$, but at the origin, the vectors from the two charges point in opposite directions and cancel so $E = 0$
- b. $V = kQ/a + kQ/a = 2kQ/a$
- c. Due to each charge $E = kQ/r^2 = kQ/(a^2 + b^2)$, but the x components cancel so we only need to add the y components $E_y = [kQ/(a^2 + b^2)] \sin \theta = [kQ/(a^2 + b^2)] b / (a^2 + b^2)^{1/2}$ which gives $E = 2kQb/(a^2 + b^2)^{3/2}$
- d. The particle will repel from the closer charge and move through the origin until it is repelled and reversed by the charge on the other side of the origin. The particle will oscillate about the origin.
- e. The particle will move away from the origin
 $U = 2kQq/a = \frac{1}{2} mv^2$ giving $v = 2(kQq/ma)^{1/2}$
- f. The particle will oscillate about the origin
-

1994E1

- a. $V = \Sigma kQ/r$ and since all the charge is equidistant from the center we get $V = kQ/R$ where $Q = \lambda L = \lambda 2\pi R$ so $V = 2\pi k\lambda$
- b. The electric field from each infinitesimal piece of the ring is cancelled from a piece on the opposite side of the ring. $E = 0$
- c. The total charge on the rod is the charge per unit length times the length of the rod: $L = 2R\theta$ so $Q = 2R\theta\lambda$
- d. As in part a, the charge is all equidistant so we substitute the new amount of charge into the expression $V = 2k\theta\lambda$
- e. $E = kQ/R^2$, all of the charge is equidistant, but we must take direction into account. The y components will cancel so we only need to consider the x (horizontal) component from each infinitesimal element $dq = \lambda R d\theta$

$$E = \int_{-\theta}^{\theta} \frac{k dq}{R^2} \cos \theta d\theta = \int_{-\theta}^{\theta} \frac{k d\lambda R}{R^2} \cos \theta d\theta = \int_{-\theta}^{\theta} \frac{k\lambda}{R} \cos \theta d\theta = \frac{k\lambda}{R} \sin \theta \Big|_{-\theta}^{\theta} = \frac{2k\lambda}{R} \sin \theta$$

pointing to the right

1998E1

a.

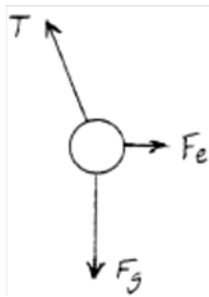

From the FBD: $T \cos \theta = mg$ and $T \sin \theta = F_e = kQ_A Q_B / r^2$ solving the two equations gives $Q = 1.9 \times 10^{-7} \text{ C}$

b. The angle is smaller since the charge will move on a conductor so the spacing between the charges is farther apart, reducing the electric force.

c.

$$\oint E \cdot dA = \frac{Q_{enc}}{\epsilon_0}$$

Left side: $E(2\pi rL)$

Right side: $\lambda L / \epsilon_0$

This gives $E = \lambda / 2\pi r \epsilon_0$

d. $F = qE = 0.14 \text{ N}$

e.

$$W = q\Delta V = -q \int E dr = -q \int_{1.5}^{0.3} \frac{1.8 \times 10^3}{r} dr = -.216 [\ln r]_{1.5}^{0.3} = 0.35 \text{ J}$$

1999E3

a. The charge on any section of the ring is equidistant from a point on the x axis so $V = kQ/r = kQ/(x^2 + R^2)^{1/2}$

b. i. $E = -dV/dr = kQx/(x^2 + R^2)$

ii. zero (the components cancel)

c. i. Set $dE_x/dx = 0$ gives $x = R/\sqrt{2}$

ii. Plugging in the value found above gives $E = kQ/(3\sqrt{3})R^2$

d.

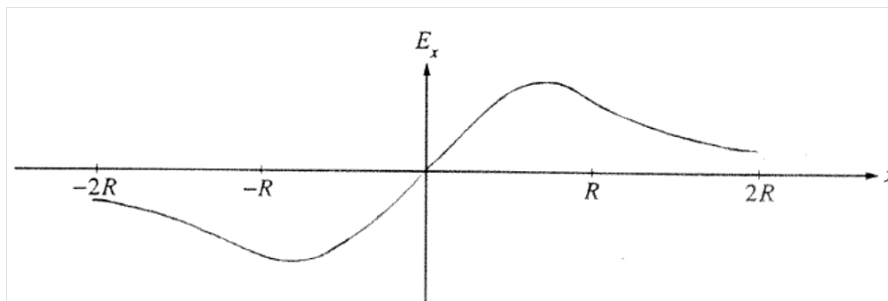

e. The electron oscillates about the origin (when displaced in the +x direction there is a force in the -x direction and vice versa)

2002E1

- a. The total charge is $q = \lambda L = \lambda(2\pi R/3) = 3.1 \times 10^{-6} \text{ C}$
 b. $E = kQ/R^2$, all of the charge is equidistant, but we must take direction into account. The y components will cancel so we only need to consider the x (horizontal) component from each infinitesimal element $dq = \lambda R d\theta$

$$E = \int_{120}^{240} \frac{k dq}{R^2} \cos\theta d\theta = \int_{120}^{240} \frac{k d\lambda R}{R^2} \cos\theta d\theta = \int_{120}^{240} \frac{k\lambda}{R} \cos\theta d\theta = \frac{k\lambda}{R} \sin\theta \Big|_{120}^{240} = 2.3 \times 10^6 \text{ N/C}$$

To the right

- c. $V = kQ/R = 2.8 \times 10^5 \text{ V}$ (all charge is equidistant from point O)
 d. $F = qE = 3.7 \times 10^{-13} \text{ N}$
 e. The proton moves off to the right, but as the force decreases the proton's acceleration decreases, all the while speeding up to the right asymptotic to some value

2010E1

- a. Compared to points A and C, point B is closer to most, and possibly all, points along the charge distribution. Since potential varies inversely with distance, point B has the highest potential. Points A and C have the same potential by symmetry.
 b. All points on the arc are a distance R from point P. Since potential is a scalar quantity, the potential will be the same as that of a point charge with charge Q located a distance R away

$$V = kQ/R$$

- c. Energy is conserved: $U_i = K_f$
 $qV = q(kQ/R) = \frac{1}{2} mv^2$ gives $v = (2kqQ/mR)^{1/2}$
 d.

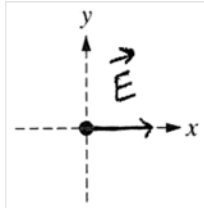

- e. $E = kQ/R^2$, all of the charge is equidistant, but we must take direction into account. The y components will cancel so we only need to consider the x (horizontal) component from each infinitesimal element dq where $dq = (2Q/\pi)d\theta$

$$|E| = \int_{-\pi/4}^{\pi/4} \frac{2kQ}{\pi R^2} \cos\theta d\theta = \frac{2kQ}{\pi R^2} \sin\theta \Big|_{-\pi/4}^{\pi/4} = \frac{2\sqrt{2}kQ}{\pi R^2}$$

SECTION B – Gauss's Law

1976E1

a.

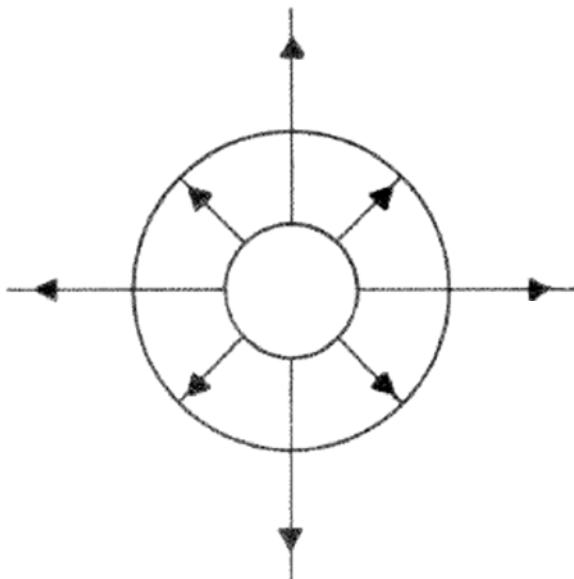

b.

$$\oint E \cdot dA = \frac{Q_{enc}}{\epsilon_0}$$

$$E(4\pi r^2) = +2Q/\epsilon_0$$

$$E = Q/2\pi\epsilon_0 r^2$$

c.

$$\Delta V = - \int E \cdot dr = - \int_R^{3R} \frac{2kQ}{r^2} dr = \frac{2kQ}{r} \Big|_R^{3R} = \frac{4kQ}{3R}$$

We can actually ignore the sign since the question asks for the general potential difference between the spheres

d. The total charge would distribute on the outer surface, leaving no charge on the inner sphere and +Q on the outer.

1979E1

a.

$$\oint E \cdot dA = \frac{Q_{enc}}{\epsilon_0}$$

$$E = kQ/r^2$$

- b. $r > c$: $Q_{enc} = 2Q$ so $E = 2kQ/r^2$
 $b < r < c$: inside a conductor $E = 0$
 $r < a$: inside a conductor $E = 0$

c.

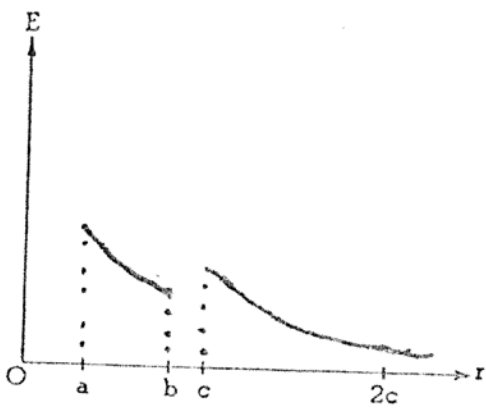

d.

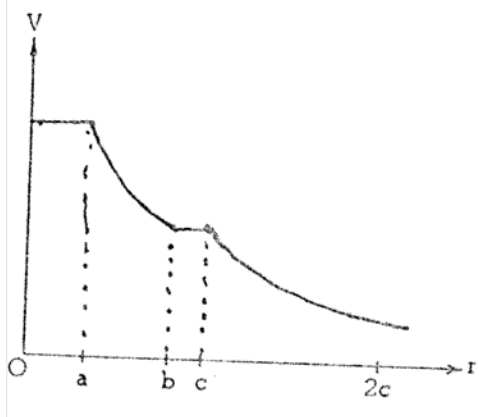

e.

$$\Delta V = - \int E \cdot dr = - \int_{\infty}^b E \cdot dr = - \int_{\infty}^c \frac{2kQ}{r^2} dr - \int_c^b 0 dr = \frac{2kQ}{c}$$

1984E2

a. $V_1 = E_1 a$ and $V_2 = E_2 b$ so $E_1/E_2 = b/a$

b.

$$\oint E \cdot dA = \frac{Q_{enc}}{\epsilon_0}$$

Left side: $E_1 A + E_2 A$ Right side: $Q_{enc} = \sigma A$

So $E_1 + E_2 = \sigma/\epsilon_0$

c.

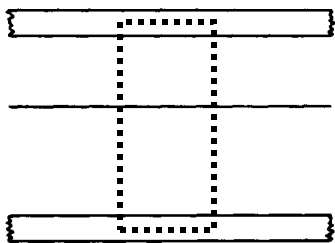

$E = 0$ in a conductor so $Q_{enc} = 0$ so $\sigma_1 A + \sigma_2 A + \sigma A = 0$, or $\sigma_1 + \sigma_2 = -\sigma$

- d. $E_1 + E_2 = \sigma/\epsilon_0$ where $E_1 = V/a$ and $E_2 = V/b$
 $V/a + V/b = \sigma/\epsilon_0$ gives $V = \sigma ab/\epsilon_0(a + b)$

1988E1

- a. $V = kQ/a$ so $Q = aV/k$

b.

$$\oint E \cdot dA = \frac{Q_{enc}}{\epsilon_0}$$

$$E(4\pi r^2) = Q/\epsilon_0$$

$$E = aV/r^2$$

c.

$$\Delta V = - \int E \cdot dr = - \int_b^a E \cdot dr = - \int_b^a \frac{kQ}{r^2} dr = kQ \left(\frac{1}{a} - \frac{1}{b} \right) = \frac{V(b-a)}{b}$$

- d. $Q = C\Delta V$
 $aV/k = CV(b-a)/b$
 $C = ab/k(b-a)$

1989E1

- a. $E = 0$ since the net charge is zero
b. $V = 0$ because the net charge is zero
c.

$$\oint E \cdot dA = \frac{Q_{enc}}{\epsilon_0}$$

The portion of the negative charge within the Gaussian surface is $-Qr^3/R^3$ (volume ratio)

The net charge enclosed is therefore $Q_{enc} = Q - Qr^3/R^3$

Applying this to Gauss's Law gives $E = kQ(1/r^2 - r/R^3)$

d.

$$\Delta V = - \int E \cdot dr = - \int_R^r E \cdot dr = - \int_R^r \left(\frac{kQ}{r^2} - \frac{kQr}{R^3} \right) dr = -kQ \left(-\frac{1}{r} - \frac{r^2}{2R^3} \right) = kQ \left(\frac{1}{r} + \frac{r^2}{2R^3} - \frac{3}{2R} \right)$$

1990E1

a.

$$\oint E \cdot dA = \frac{Q_{enc}}{\epsilon_0}$$

The portion of the charge within the Gaussian surface is Qr^3/R^3 (volume ratio)

$E(4\pi r^2) = Qr^3/R^3$ giving $E = kQr/R^3$

- b. $Q_{enc} = Q$ so $E = kQ/r^2$
c. inside a conductor $E = 0$
d. Since $E = 0$ for r inside the conductor, the total charge enclosed by such a sphere must be zero. The inner surface therefore has induced charge $-Q$ over its surface of area $4\pi(2R)^2$ which gives $\sigma = -Q/16\pi R^2$
e. Since the shell has a net charge $+q$, the outer surface charge combined with the inner surface charge should add to this value: $q_{outer} + q_{inner} = +q = q_{outer} - Q$ so $q_{outer} = q + Q$ distributed over its surface of area $4\pi(3R)^2$ which gives $\sigma_{outer} = (q + Q)/36\pi R^2$

1992E1

- a. From a given volume charge density: $Q = \int \rho \, dV$

$$Q = \int_0^a \rho 4\pi r^2 dr = \int_0^a 4\pi \beta r^3 dr = 4\pi \beta \left. \frac{r^4}{4} \right|_0^a = \beta \pi a^4$$

- b. i. for $r > a$ the sphere can be treated as a point charge where $E = kQ/r^2 = \beta a^4/4\epsilon_0 r^2$
 ii. $R = a$ is a limiting case of (i) above so just substitute $r = a$, which gives $E = \beta a^2/4\epsilon_0$
 iii. Using Gauss's Law: left side = $E4\pi r^2$; right side:

$$Q_{enc} = \int_0^r \rho 4\pi r^2 dr = \int_0^r 4\pi \beta r^3 dr = 4\pi \beta \frac{r^4}{4} \Big|_0^r = \beta \pi r^4$$

giving $E = \beta r^2/4\epsilon_0$

- c. i. This is a limiting case of $r > a$, where the sphere can be treated as a point charge and $V = kQ/r = \beta a^3/4\epsilon_0$
 ii.

$$\Delta V = - \int E \cdot dr = - \int_{\infty}^0 E \cdot dr = - \int_{\infty}^a \frac{\beta a^4}{4\epsilon_0 r^2} dr - \int_a^0 \frac{\beta r^2}{4\epsilon_0} dr = V(r = a) - \frac{\beta}{4\epsilon_0} \frac{r^3}{3} \Big|_a^0 = \frac{\beta a^3}{3\epsilon_0}$$

1995E1

a.

$$\oint E \cdot dA = \frac{Q_{enc}}{\epsilon_0}$$

$$E(2\pi rL) = Q_{enc}/\epsilon_0 = \lambda L/\epsilon_0$$

$$E = \lambda/2\pi\epsilon_0 r$$

b. i.

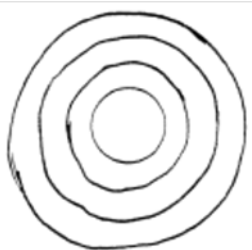

ii.

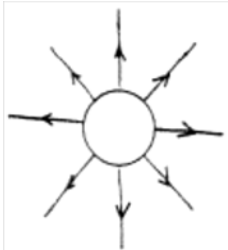

c. i.

$$\Delta V = - \int E \cdot dr$$

$$V_C - V_D = - \int_D^C E \cdot dr = \int_C^D E \cdot dr = \int_C^D \frac{\lambda}{2\pi\epsilon_0} \frac{dr}{r} = \frac{\lambda}{2\pi\epsilon_0} \ln r \Big|_a^{3a} = \frac{\lambda}{2\pi\epsilon_0} \ln 3$$

ii. $W = Q\Delta V = (Q\lambda \ln 3)/2\pi\epsilon_0$

d.

$$\oint E \cdot dA = \frac{Q_{enc}}{\epsilon_0}$$

$$\epsilon_0 E(2\pi r l) = \int_0^r \rho_0 \left(\frac{r}{a}\right)^{\frac{1}{2}} (2\pi r l) dr = \frac{2\pi l \rho_0}{\sqrt{a}} \int_0^r r^{\frac{3}{2}} dr = \frac{4\pi l \rho_0 r^{\frac{5}{2}}}{5\sqrt{a}}$$

$$E = \frac{2\rho_0 r^{\frac{3}{2}}}{5\epsilon_0 \sqrt{a}}$$

1996E1

- a. The sphere is metal, all charge resides on the outer surface and can be treated as a point charge where $V = kQ/r$
 $V_0 = kQ_0/a$ so $Q_0 = 4\pi\epsilon_0 V_0 a$ or $V_0 a/k$
- b. i. E inside a conductor is zero, therefore the inner surface of the shell must carry a charge equal and opposite to that of the sphere to cancel the field from the sphere: $Q_{\text{inner}} = -Q_0$
 ii. The net charge on the shell is zero so the charge on the outer surface must cancel that on the inner surface so $Q_{\text{outer}} = +Q_0$
- c. i. E = 0 inside a conductor (zero field has no direction)
 ii. Only the charge inside the region contributes to the field. It can be treated as a point charge: $E = kQ_0/r^2$ directed radially outward
 iii. E = 0 inside a conductor (zero field has no direction)
 iv. Equivalent to the situation in (ii) $E = kQ_0/r^2$ directed radially outward
- d. Yes, the charges induced on the inner and outer surfaces appear as the shell is being assembled and the fact that the negative charge is closer means there is a net attractive force.
- e.

$$\Delta V = - \int E \cdot dr = - \int_{\infty}^{2b} \frac{kQ_0}{r^2} dr - \int_b^a \frac{kQ_0}{r^2} dr = kQ_0 \left(\frac{1}{r} \Big|_{\infty}^{2b} + \frac{1}{r} \Big|_b^a \right) = kQ_0 \left(\frac{2b-a}{2ab} \right) = V_0 \left(\frac{2b-a}{2b} \right)$$

1997E2

- a. The sphere can be treated as a point charge: $E = kQ/R^2$ to the right
- b. The flux is represented by either side of Gauss's Law: Q/ϵ_0 or $4\pi R^2 E$
- c. The new field is the vector sum of the fields from the sphere and the point charge
 From the sphere: kQ/R^2 to the right from the point charge: kQ/R^2 downward
 from the Pythagorean theorem: $E_{\text{net}} = \sqrt{2}kQ/R^2$ 45° from the horizontal, down and to the right
- d. i. Only those charges inside contribute to the net electric flux: q_2 and q_3
 ii. All four charges contribute to the value of the electric field at point P_1
 iii. Different, the electric field is the sum of the individual fields while the flux is the sum of components over the whole surface
- e. No. Charges may exist outside the surface that would contribute to a field on the surface or, for example, the surface may enclose a dipole, which would cause a net field at some points
- f. Yes. A zero net field means the flux is also zero. Since charges inside the surface contribute to the net flux, there can be no net charge inside the surface.
-

2003E1

- a. The sphere can be treated as a point charge
 i. $E = kQ/r^2$
 ii. $V = kQ/r$
- b. The proton will move away from the sphere, its velocity will increase to reach some final value asymptotically while the acceleration decreases
- c. $K = U_r - U_R = (-keQ/r) - (-keQ/R) = keQ(1/R - 1/r)$
- d. ρ_0 can be determined by integrating the volume distribution and setting it equal to the total charge Q

$$Q = \int_0^R \rho(r) dV = \int_0^R \rho_0 \left(1 - \frac{r}{R}\right) 4\pi r^2 dr = 4\pi\rho_0 \frac{R^3}{12} \text{ so } \rho_0 = \frac{3Q}{\pi R^3}$$

e.

$$Q_{\text{enc}} = \int_0^r \rho(r) dV = \int_0^r \frac{3Q}{\pi R^3} \left(1 - \frac{r}{R}\right) 4\pi r^2 dr = \frac{Q}{R^3} \left(4r^3 - \frac{3r^4}{R}\right)$$

Substituting into Gauss's Law gives

$$E = \frac{kQr}{R^3} \left(4 - \frac{3r}{R}\right)$$

2004E1

a.

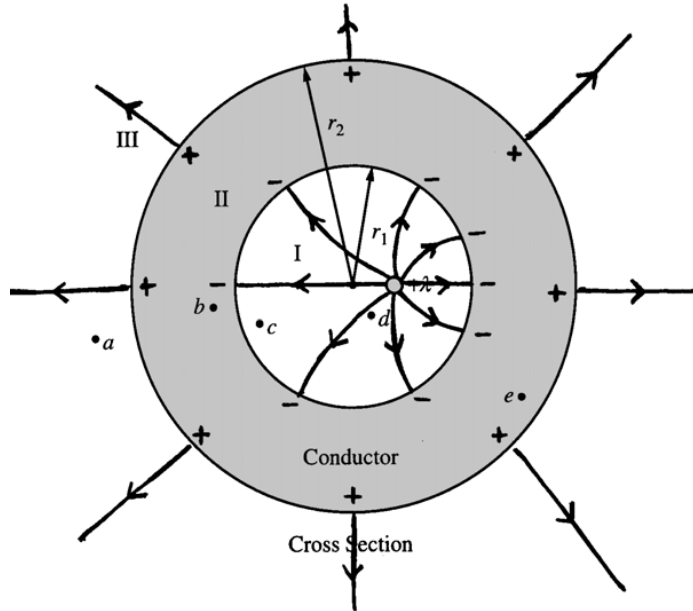

b. 4-3-2-1-3 respectively (b and e within the conductor are at the same potential)

c. i.

$$\oint E \cdot dA = \frac{Q_{enc}}{\epsilon_0}$$

$$E(2\pi rL) = Q_{enc}/\epsilon_0 = \lambda L/\epsilon_0$$

$$E = \lambda/2\pi\epsilon_0 r$$

ii. $Q_{enc} = Q_{line} + Q_{shell,inside}$ where the portion of the shell's charge within the Gaussian surface is $\rho(\pi r^2 - \pi r_1^2)$ so combining the electric fields from the line and shell gives $E = \lambda/2\pi\epsilon_0 r + (\rho/2\epsilon_0 r)(r^2 - r_1^2)$

iii. Outside the shell, we can just replace r with r_2 , enclosing all the charge of the shell:

$$E = \lambda/2\pi\epsilon_0 r + (\rho/2\epsilon_0 r)(r_2^2 - r_1^2)$$

2007E2

a. For all parts, the left side of Gauss's Law will be $E4\pi r^2$, the right side will be related to the net charge enclosed

i. The portion of the charge within the Gaussian surface is Qr^3/a^3 (volume ratio)

$$E(4\pi r^2) = Qr^3/a^3 \text{ giving } E = kQr/a^3$$

ii. Between the sphere and the shell we can treat the sphere as a point charge where $E = kQ/r^2$

iii. $Q_{enc} = Q - \rho_0 V_0$ where ρ_0 is the charge density of the outer sphere and V_0 is the volume of the outer sphere enclosed by the Gaussian surface

$$\rho_0 = \frac{Q}{\frac{4}{3}\pi(3a)^3 - \frac{4}{3}\pi(2a)^3} = \frac{Q}{\frac{4}{3}\pi a^3(19)}$$

$$V_0 = \frac{4}{3}\pi r^3 - \frac{4}{3}\pi(2a)^3 = \frac{4}{3}\pi(r^3 - 8a^3)$$

$$Q_{enc} = Q - \frac{Q}{\frac{4}{3}\pi a^3(19)} \frac{4}{3}\pi(r^3 - 8a^3) = \frac{Q}{19} \left(27 - \frac{r^3}{a^3} \right)$$

$$\oint E \cdot dA = \frac{Q_{enc}}{\epsilon_0} = E(4\pi r^2)$$

$$E = \frac{Q}{76\pi\epsilon_0 r^2} \left(27 - \frac{r^3}{a^3} \right)$$

iv. No charge is enclosed so $E = 0$

b. Since $V = \int E dr$ and $E = 0$ from infinity to $3a$, it follows that $V = 0$

c.

$$\Delta V = - \int E \cdot dr = - \int_{2a}^a E \cdot dr = - \int_{2a}^a \frac{kQ}{r^2} dr = -kQ \left. -\frac{1}{r} \right|_{2a}^a = kQ \left(\frac{1}{a} - \frac{1}{2a} \right) = \frac{Q}{8\pi\epsilon_0 a}$$

2008E1

- a. i. Applying Gauss's Law to a Gaussian surface within the shell gives $Q_{enc} = 0$ since the field in the conductor is zero. Therefore the charge on the inner surface is $-Q$.
 ii. The net charge on the shell is zero, therefore the charge on the outer surface must be equal and opposite to the charge on the inner surface, $Q_{outer} = +Q$
- b. i. Since the sphere is a conductor, all the charge lies on the outer surface, applying Gauss's Law to any Gaussian surface inside the sphere gives $Q_{enc} = 0$ therefore $E = 0$
 ii. We can treat the sphere as a point charge where $E = kQ/r^2$
 iii. Inside a conductor $E = 0$
 iv. The net charge enclosed is $+Q$ (treat both objects as point charges): $E = kQ/r^2$
- c.

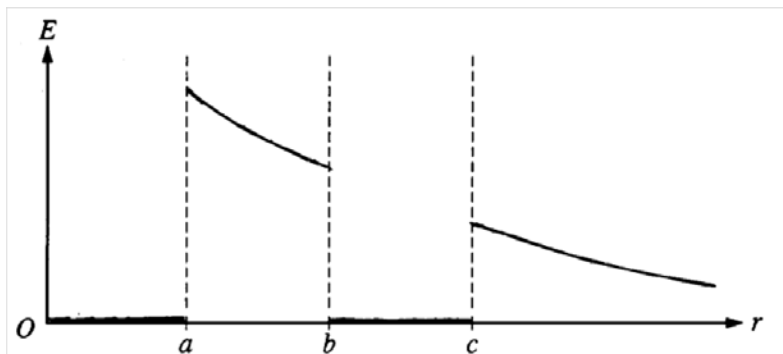

d. $K + U = 0$

$$\frac{1}{2} m_e v^2 + \frac{kQ(-e)}{10r} = 0 \text{ gives } v = \sqrt{\frac{kQe}{5m_e r}}$$

2011E1

a.

$$\oint E \cdot dA = \frac{Q_{enc}}{\epsilon_0}$$

The Gaussian surface is a sphere, concentric with the charged shell, and with a radius less than the radius of the shell. The enclosed charge Q is zero for all radii of the Gaussian surface; therefore, the electric field E is also zero everywhere inside the sphere.

- b. No. With an asymmetric distribution, the fields from individual charges no longer have the net effect of completely cancelling out.
- c. ABCD, ABGH, ADEH
 The electric field from the sphere is radial, so it is parallel to the three faces selected
- d. Corner A is inside the conducting sphere so the electric field there is zero.
- e. $E = 0$
- f. total flux = Q_{enc}/ϵ_0 , the cube encloses $1/8$ of the charge so $Q_{enc} = Q/8$
 The flux is the same through each of the three nonzero flux sides and is therefore each equal to $1/3$ of the total flux through the cube so the flux through CDEF = $Q/24\epsilon_0$

SECTION C – Electric Potential and Energy

1975E1

- a. $U = \Sigma kqV = \Sigma kq^2/r = 2kq^2/r = 2kq^2/(x^2 + \ell^2)$
 b. Each $F = kq^2/r^2 = kq^2/(x^2 + \ell^2)$
 The y components of the forces cancel, leaving just the x components (and $x = \ell$). This gives $F = kq^2/\sqrt{2}\ell^2$
 c. $W_{\text{field}} = -q\Delta V = -(U_0 - U_\infty) = -2kq^2/\ell - 0 = -2kq^2/\ell$

1977E1

- a. All parts of the ring are equidistant from point P and $V = kQ/r = kQ/(R^2 + x^2)^{1/2}$
 b. V is a maximum where $(R^2 + x^2)$ is at a minimum, which is at $x = 0$
 c. All parts of the ring are equidistant from point P and $E = kQ/r^2$, but only the x components are relevant since the components perpendicular to the x axis cancel. The net field is therefore $E = E_x = (kQ/r^2) \cos \theta$ and $\cos \theta = x/(x^2 + R^2)^{1/2}$, which gives $E = kQx/(R^2 + X^2)^{3/2}$
 d.

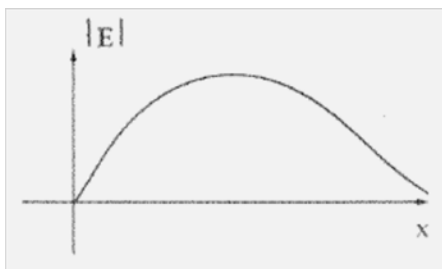

1980E1

- a. Each part of the ring is equidistant from the center and $V_o = kQ/R$ where $Q = \lambda L = \lambda \pi R$ giving $V_o = k\lambda \pi$
 b. Because of the symmetry of the charge distribution, all horizontal components cancel, thus the field is directed downward (toward the bottom of the page)
 c. Since we only need to consider vertical components we can use $dE_y = dE \cos \theta$ where θ is the angle from our differential charge element and the y axis. The differential charge element $dq = \lambda dl = \lambda R d\theta$

$$dE_y = \frac{\lambda \cos \theta d\theta}{4\pi\epsilon_0 R}$$

$$E = \frac{\lambda}{4\pi\epsilon_0 R} 2 \int_0^{\pi/2} \cos \theta d\theta = \frac{2k\lambda}{R}$$

- d. The work required to bring a charge from infinity to point P is $W = qV_P$
 The work required to bring a charge from P to O is $W = q(V_o - V_P)$
 If the field is assumed to be approximately constant between O and P the work is also given by $W_{OP} = qE_o s$
 Therefore $W_P = qV_P = q(V_o - E_o s)$

1982E1

- a. $V = \Sigma kq/r = V_1 + V_2 + V_3 = kq/(a^2 + x^2)^{1/2} + kq/(a^2 + x^2)^{1/2} - kq/x = 0$ which gives $x = \pm a/\sqrt{3}$
 b. By symmetry $E_y = 0$, $E_x = E \cos \theta = E(x/(a^2 + x^2)^{1/2})$
 $E_x = \Sigma E \cos \theta = E_{1x} + E_{2x} + E_{3x} = 2kqx/(a^2 + x^2)^{1/2} - kq/x^2$
 c. By Gauss's Law the net flux = $Q_{\text{enc}}/\epsilon_0 = q/\epsilon_0$ (or $4\pi kq$)

1986E1

a.

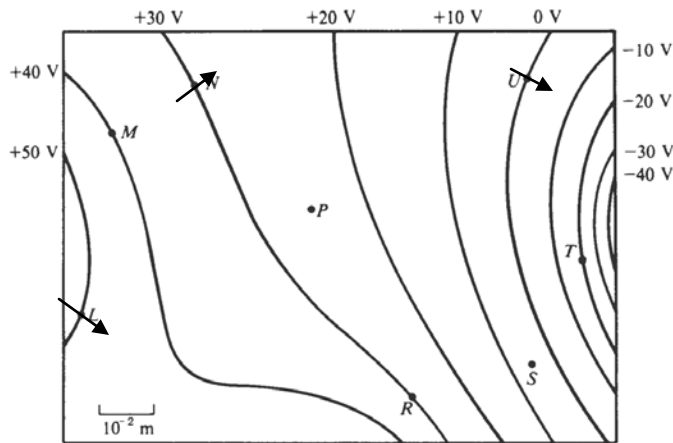

- b. E is greatest at point T because the equipotentials are closest together (largest gradient)
- c. $E = \Delta V / \Delta x = 10 \text{ V} / 0.02 \text{ m} = 500 \text{ V/m}$
- d. $V_M - V_S = 40 \text{ V} - 5 \text{ V} = 35 \text{ V}$
- e. $W_{\text{field}} = -q\Delta V = -(5 \text{ pC})(30 \text{ V} - 40 \text{ V}) = 5 \times 10^{-11} \text{ J}$
- f. No, work does not depend on path

1987E1

- a. Outside the sphere we treat the sphere as a point charge: $E = kQ/r^2$
- b. The portion of the charge within the Gaussian surface is Qr^3/R^3 (volume ratio)
 $E(4\pi r^2) = Qr^3/R^3$ giving $E = kQr/R^3$
- c. The surface of the sphere is a limiting case for the potential outside the sphere, which can be treated as a point charge, where $V = kQ/r$ so on the surface $V = kQ/R$
- d. $V_{\text{center}} = V_{\text{surface}} + \int E dr = kQ/R + kQ/R^3 [R^2/2] = 3kQ/2R$

2000E2

a. i.

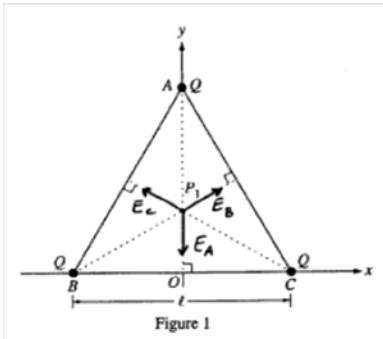

ii.

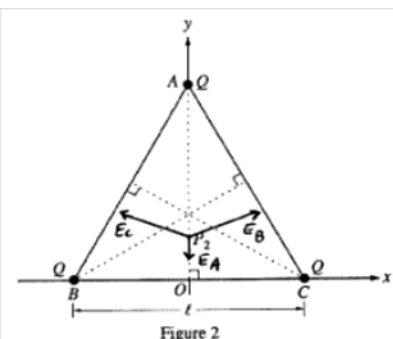

	Greater than at P_1	Less than at P_1	The same as at P_1
E_A		✓	
E_B	✓		
E_C	✓		

- b. The x components of the field vectors due to particles C and B cancel each other due to the symmetry created by having a vertex of the triangle on the y axis.
- c. $V = \Sigma kQ/r = k(Q_A/r_A + Q_B/r_B + Q_C/r_C) = k(Q_A/r_A + 2Q/r_B)$, with the proper substitutions this gives

$$V = k \left(\frac{Q}{\frac{\sqrt{3}l}{2} - y} + \frac{2Q}{\sqrt{\frac{l^2}{4} + y^2}} \right)$$

- d. Since $E_y = -dV(y)/dy$, to find the y coordinate of the point on the y-axis at which the electric field is zero, take the derivative of the expression in part (c) with respect to y, set the expression equal to zero and solve for y

2001E1

- a. Since the charges are all aligned directly above and below point P_1 we can write $E = \Sigma kq/r^2$, letting up be positive and down be negative. We get $E = -k(30)/(3000)^2 + k(30)/(2000)^2 + k(30)/(2000)^2 - k(30)/(3000)^2$
 $E = 75,000 \text{ N/C}$ upward
- b. i. The electric field points directly upward
 ii. Less, since P_2 is farther from all the charges than P_1
- c. i. $V = \Sigma kQ/r = k(30/3000 - 30/2000 + 30/2000 - 30/3000) = 0$
 ii. $V = 0$ here as well
- d. $V = \Sigma kQ/r = k(30/2000 - 30/1000 + 30/3000 - 30/4000) = -1.12 \times 10^8 \text{ V}$
- e. $U = \Sigma kq_i q_j / r_{ij} = k[(30)(-30)/1000 + (30)(30)/5000 + (30)(-30)/6000 + (30)(-30)/4000 + (-30)(-30)/5000 + (30)(-30)/1000] = -1.6 \times 10^{10} \text{ J}$

2005E1

- a. i. The field is greatest at point C where the field lines are closest together.
 ii. The potential is greatest at point A, electric fields point in the direction of decreasing potential.
- b. i. The electric moves to the left with increasing speed and decreasing acceleration
 ii. $\frac{1}{2} mv^2 = q\Delta V$ gives $v = (2q\Delta V/m)^{1/2} = 1.9 \times 10^6 \text{ m/s}$
- c. If we assume the field is uniform: $E = -\Delta V/r = 20 \text{ V}/0.01 \text{ m} = 2000 \text{ V/m}$
- d.

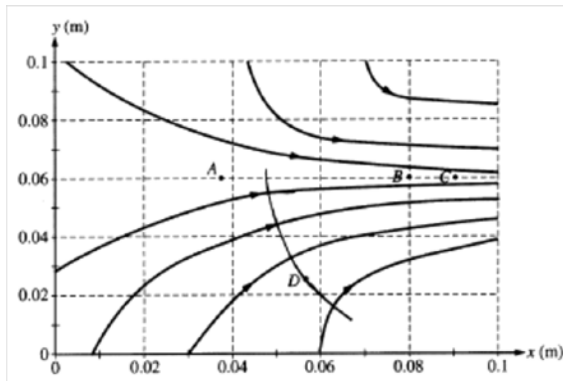

2006E1

a.

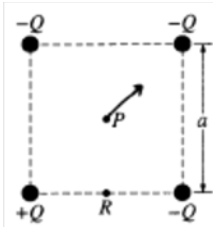

- b. i. The field due to the upper left and lower right charges are equal in magnitude and opposite in direction so they cancel out. The fields due to the other two charges are equal in magnitude and in the same direction so they add $E = 2kQ/r^2$ where $r^2 = a^2/2$ which gives $E = 4kQ/a^2$
 ii. $V = \sum kQ/r = k(-Q-Q+Q+Q)/r = -2kQ/r$ where $r = a/\sqrt{2}$ giving $V = -2\sqrt{2}kQ/a$
 c. Negative. The field is directed generally from R to P (away from the positive charge and toward the negatives) and the charge moves in the opposite direction, thus the field does negative work on the charge.
 d. i. Replace the top right negative charge with a positive charge *or* replace the bottom left positive charge with a negative charge,. The vectors will all then cancel from oppositely located same charge pairs.
 ii. Replace the top left negative charge with a positive charge *or* replace the bottom right negative charge with a positive charge. The scalar potentials all cancel (2 positive and 2 negative) but the fields do not.

2009E1

a. i.

$$E = -\frac{dV}{dr} = -\frac{d}{dr} \frac{kQ}{R} \left[-2 + 3\left(\frac{r}{R}\right)^2 \right] = -\frac{kQ}{R} \left[(3)(2)\left(\frac{r}{R}\right)\left(\frac{1}{R}\right) \right] = -\frac{6kQ_0r}{R^3}$$

$$|E| = \frac{6kQ_0r}{R^3}$$

Directed inward ($E < 0$)

ii. $E = -dV/dr = kQ_0/r^2$ directed outward

b. i.

$$\oint E \cdot dA = \frac{Q_{enc}}{\epsilon_0}$$

$$E4\pi r^2 = Q_{enc}/\epsilon_0$$

$$E_{inside} = \frac{Q_{enclosed,r < R}}{4\pi\epsilon_0 r^2} = -\frac{6kQ_0r}{R^3}$$

$$Q_{enclosed,r < R} = -\frac{6Q_0r^3}{R^3}$$

ii.

$$E4\pi r^2 = Q_{enc}/\epsilon_0$$

$$E_{outside} = \frac{Q_0}{4\pi\epsilon_0 r^2} = \frac{Q_{enclosed,r > R}}{4\pi\epsilon_0 r^2}$$

$$Q_{enclosed,r > R} = +Q_0$$

c. Yes. The total enclosed charge equals the charge at the surface plus all the charge inside the sphere

$$Q_{enclosed,r > R} = Q_{surface} + Q_{enclosed,r < R} \text{ at } r = R$$

$$Q_{surface} = Q_0 - (-6Q_0R^3/R^3) = 7Q_0$$

d.

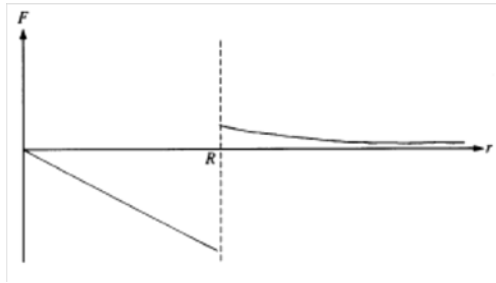

SECTION D – Capacitance

1978E3

a.

$$\oint E \cdot dA = \frac{Q_{enc}}{\epsilon_0}$$

$$\epsilon_0 E_0 4\pi a^2 = Q$$

b. $E = kQ/r^2 = E_0 a^2/r^2$

c. $V = kQ/r$ $kQ = E_0 a^2$ $V(a) = kQ/a$ $V(b) = kQ/b$

$$\Delta V = E_0 a^2 (1/a - 1/b)$$

d. $U = \frac{1}{2} Q \Delta V = 2\pi\epsilon_0 E_0^2 (a^3 - a^4/b)$

e. setting $dU/da = 0$ gives $a = \sqrt[3]{4}b$

1980E2

a.

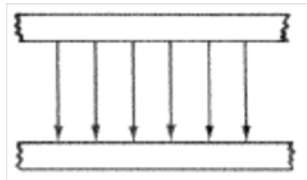

b.

$$\oint E \cdot dA = \frac{Q_{enc}}{\epsilon_0}$$

$Q_{enc} = \sigma A$ and E through the top of the box is zero, only the bottom of the box has a non-zero flux

$$EA = \sigma A/\epsilon_0 \text{ gives } E = \sigma/\epsilon_0$$

c. The electric field is less. The bound charge distribution in the dielectric has a net negative charge on the top surface and positive on the bottom due to induction. Thus the combined charge is less and so is the electric field.

1981E1

a.

$$\oint E \cdot dA = \frac{Q_{enc}}{\epsilon_0}$$

$$E(4\pi r^2) = Q/\epsilon_0$$

$$E = Q/4\pi\epsilon_0 r^2$$

b. $C = Q/\Delta V$ where $\Delta V = kQ/a - kQ/b$ giving $C_0 = 4\pi\epsilon_0(ab/b - a)$

- c. Consider the system as two capacitors in parallel $C_{\text{top}} = C_0/2$ (half the area) and $C_{\text{bottom}} = \kappa C_0/2 = C_0/2 \times 4$
 In parallel $C_{\text{total}} = C_{\text{top}} + C_{\text{bottom}} = 5C_0/2$
-

1983E1

a.

$$\oint E \cdot dA = \frac{Q_{\text{enc}}}{\epsilon_0}$$

$$E(4\pi r^2) = Q/\epsilon_0$$

$$E = Q/4\pi\epsilon_0 r^2$$

- b. $\Delta V = kQ/a - kQ/b = kQ(b-a)/ab$
 c. $C = Q/\Delta V$ giving $C = 4\pi\epsilon_0(ab/b-a)$
-

1985E1

a.

$$\oint E \cdot dA = \frac{Q_{\text{enc}}}{\epsilon_0}$$

$$E(2\pi rL) = Q_{\text{enc}}/\epsilon_0 = Q/\epsilon_0$$

$$E = Q/2\pi\epsilon_0 Lr$$

b. i.

$$\Delta V = - \int E \cdot dr$$

$$V_C - V_D = - \int_D^C E \cdot dr = \int_C^D E \cdot dr = \int_C^D \frac{Q}{2\pi\epsilon_0 L} \frac{dr}{r} = \frac{Q}{2\pi\epsilon_0 L} \ln r \Big|_a^b = \frac{Q}{2\pi\epsilon_0 L} \ln \frac{b}{a}$$

- c. $C_0 = Q/V = 2\pi\epsilon_0 L / \ln(b/a)$
 d. Consider the system as two capacitors in parallel, $C = C_1 + C_2$
 $C_{\text{left}} = \kappa C_0/3$ and $C_{\text{right}} = 2/3 C_0$ giving $C = 4/3 C_0$
-

1999E1

- a. $V = kQ/r$, or $Q = rV/k = -4.4 \times 10^{-8} \text{ C}$
 b. i. $E = 0$ inside a conductor
 ii. Treat the sphere as a point charge $E = kQ/r^2 = 396/r^2 \text{ N/C}$
 iii. $E = 0$ inside a conductor
 iv. $E = 0$ since grounding the outer sphere gives it a charge of $-Q_0$ induced to its inner surface
 c. $\Delta V = V(a) - V(b) = kQ/a - kQ/b = 1000 \text{ V}$
 d. $C = Q_0/V = 4.4 \times 10^{-11} \text{ F}$

Chapter 9

Circuits

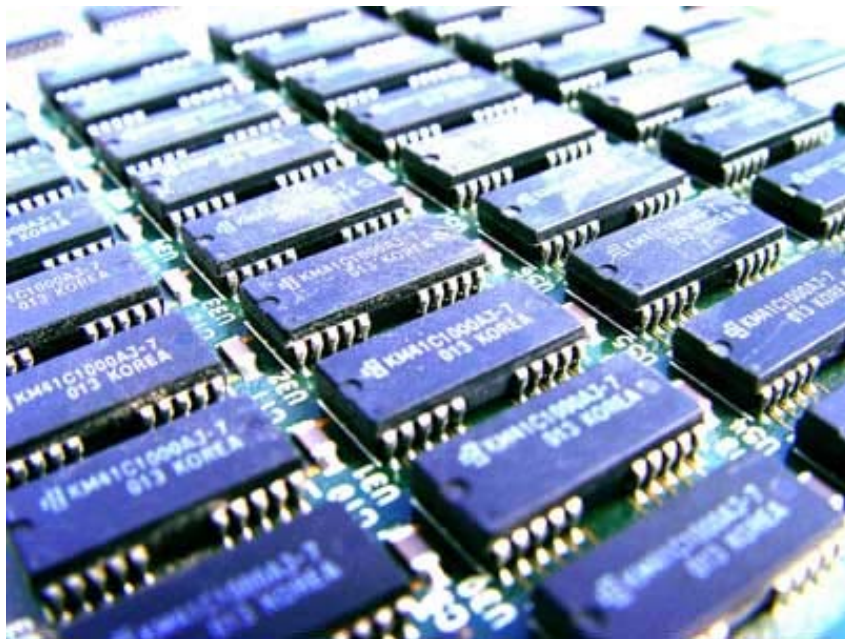

AP Physics C Multiple Choice Practice – Circuits

- When lighted, a 100-watt light bulb operating on a 110-volt household circuit has a resistance closest to
 (A) $10^{-2} \Omega$ (B) $10^{-1} \Omega$ (C) 1Ω (D) 10Ω (E) 100Ω
- If i is current, t is time, E is electric field intensity, and x is distance, the ratio of $\int i dt$ to $\int E dx$ may be expressed in
 (A) coulombs (B) joules (C) newtons (D) farads (E) henrys

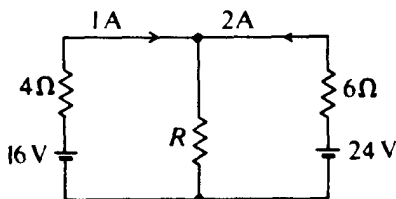

- In the circuit shown above, what is the resistance R ?
 (A) 3Ω (B) 4Ω (C) 6Ω (D) 12Ω (E) 18Ω
- The five resistors shown below have the lengths and cross-sectional areas indicated and are made of material with the same resistivity. Which has the greatest resistance?

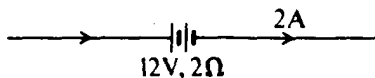
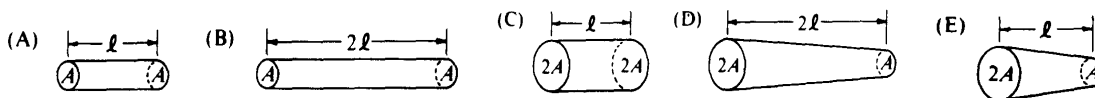

- A 12-volt storage battery, with an internal resistance of 2Ω , is being charged by a current of 2 amperes as shown in the diagram above. Under these circumstances, a voltmeter connected across the terminals of the battery will read
 (A) 4 V (B) 8 V (C) 10 V (D) 12 V (E) 16 V
- A galvanometer has a resistance of 99 ohms and deflects full scale when a current of 10^{-3} ampere passes through it. In order to convert this galvanometer into an ammeter with a full-scale deflection of 0.1 ampere, one should connect a resistance of
 (A) 1Ω in series with it
 (B) 901Ω in series with it
 (C) $9,900 \Omega$ in series with it
 (D) 1Ω in parallel with it
 (E) $9,900 \Omega$ in parallel with it

Questions 7-9

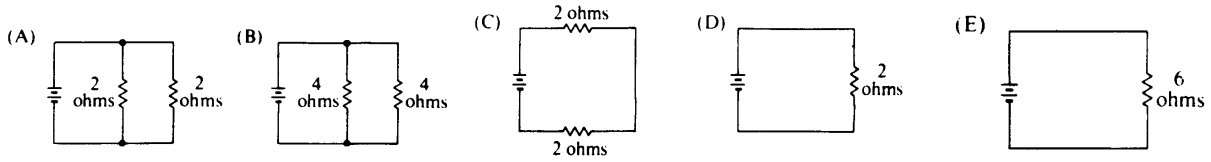

The batteries in each of the circuits shown above are identical and the wires have negligible resistance.

7. In which circuit is the current furnished by the battery the greatest?
(A) (B) (C) (D) (E)
8. In which circuit is the equivalent resistance connected to the battery the greatest?
(A) (B) (C) (D) (E)
9. Which circuit dissipates the least power?
(A) (B) (C) (D) (E)

Questions 10-12 refer to the circuit shown below.

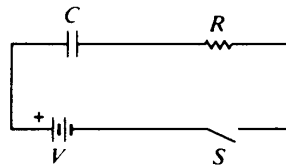

Assume the capacitor C is initially uncharged. The following graphs may represent different quantities related to the circuit as functions of time t after the switch S is closed

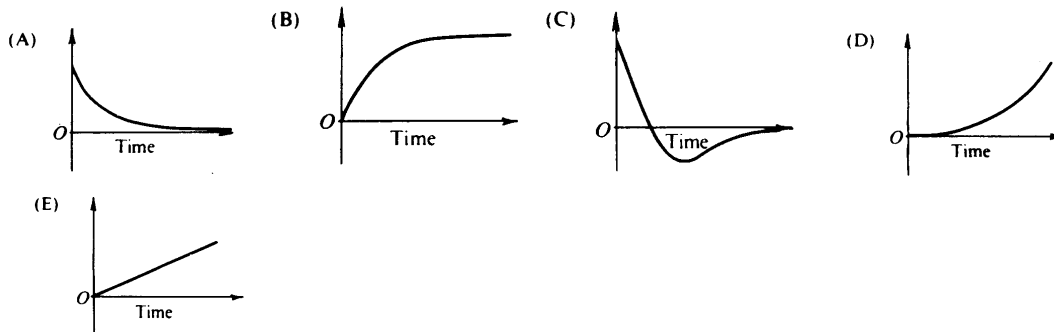

10. Which graph best represents the voltage versus time across the resistor R ?
(A) (B) (C) (D) (E)
11. Which graph best represents the current versus time in the circuit?
(A) (B) (C) (D) (E)
12. Which graph best represents the voltage across the capacitor versus time?
(A) (B) (C) (D) (E)

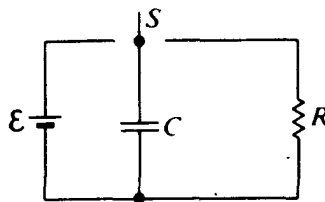

13. In the circuit shown above, the capacitor C is first charged by throwing switch S to the left, then discharged by throwing S to the right. The time constant for discharge could be increased by which of the following?
- (A) Placing another capacitor in parallel with C
 - (B) Placing another capacitor in series with C
 - (C) Placing another resistor in parallel with the resistor R
 - (D) Increasing battery emf \mathcal{E}
 - (E) Decreasing battery emf \mathcal{E}

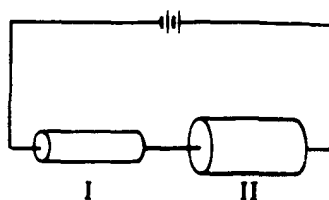

14. Two resistors of the same length, both made of the same material, are connected in a series to a battery as shown above. Resistor II has a greater cross sectional area than resistor I. Which of the following quantities has the same value for each resistor?
- (A) Potential difference between the two ends
 - (B) Electric field strength within the resistor
 - (C) Resistance
 - (D) Current per unit area
 - (E) Current
15. The emf of a battery is 12 volts. When the battery delivers a current of 0.5 ampere to a load, the potential difference between the terminals of the battery is 10 volts. The internal resistance of the battery is
- (A) 1Ω
 - (B) 2Ω
 - (C) 4Ω
 - (D) 20Ω
 - (E) 24Ω

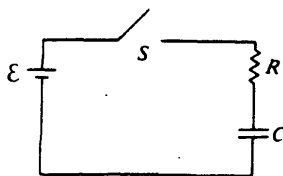

16. In the circuit shown above, the capacitor is initially uncharged. At time $t = 0$, switch S is closed. The natural logarithmic base is e . Which of the following is true at time $t = RC$?
- (A) The current is \mathcal{E}/eR .
 - (B) The current is \mathcal{E}/R
 - (C) The voltage across the capacitor is \mathcal{E} .
 - (D) The voltage across the capacitor is \mathcal{E}/e .
 - (E) The voltages across the capacitor and resistor are equal.

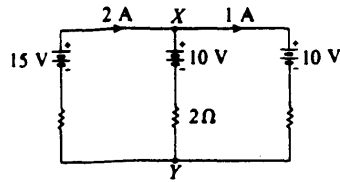

17. In the circuit shown above, the emf's of the batteries are given, as well as the currents in the outside branches and the resistance in the middle branch. What is the magnitude of the potential difference between X and Y ?
 (A) 4 V (B) 8 V (C) 10 V (D) 12 V (E) 16 V
18. The power dissipated in a wire carrying a constant electric current I may be written as a function of I , the length l of the wire, the diameter d of the wire, and the resistivity ρ of the material in the wire. In this expression, the power dissipated is directly proportional to which of the following?
 A) l only B) d only C) l and ρ only D) d and ρ only E) l , d , and ρ

Questions 19-21

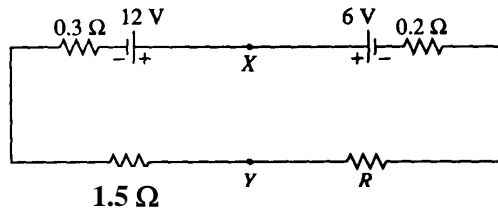

In the circuit above, the emf's and the resistances have the values shown. The current I in the circuit is 2 amperes.

19. The resistance R is
 A) 1 Ω B) 2 Ω C) 3 Ω D) 4 Ω E) 6 Ω
20. The potential difference between points X and Y is
 A) 1.2 V B) 6.0 V C) 8.4 V D) 10.8 V E) 12.2 V
21. How much energy is dissipated by the 1.5-ohm resistor in 60 seconds?
 A) 6 J B) 180 J C) 360 J D) 720 J E) 1,440 J

Questions 22-23

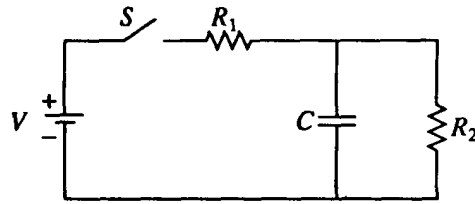

In the circuit shown above, the battery supplies a constant voltage V when the switch S is closed. The value of the capacitance is C , and the value of the resistances are R_1 and R_2 .

22. Immediately after the switch is closed, the current supplied by the battery is
 A) $V/(R_1 + R_2)$ B) V/R_1 C) V/R_2 D) $V(R_1 + R_2)/R_1R_2$ E) zero
23. A long time after the switch has been closed, the current supplied by the battery is
 A) $V/(R_1 + R_2)$ B) V/R_1 C) V/R_2 D) $V(R_1 + R_2)/R_1R_2$ E) zero

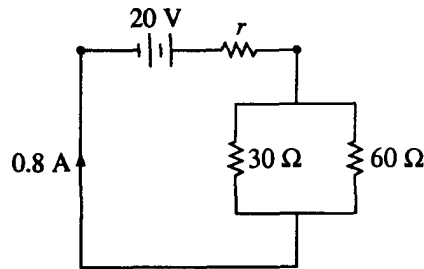

24. A 30-ohm resistor and a 60-ohm resistor are connected as shown above to a battery of emf 20 volts and internal resistance r . The current in the circuit is 0.8 ampere. What is the value of r ?
 A) 0.22Ω B) 4.5Ω C) 5Ω D) 16Ω E) 70Ω
25. A variable resistor is connected across a constant voltage source. Which of the following graphs represents the power P dissipated by the resistor as a function of its resistance R ?

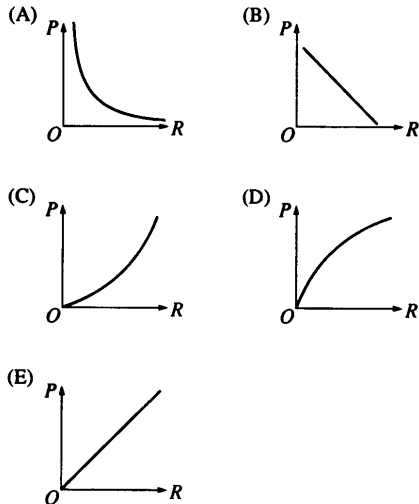

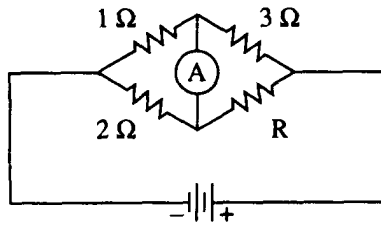

26. If the ammeter in the circuit above reads zero, what is the resistance R ?
 A) 1.5Ω B) 2Ω C) 4Ω D) 5Ω E) 6Ω
27. A resistor R and a capacitor C are connected in series to a battery of terminal voltage V_0 . Which of the following equations relating the current I in the circuit and the charge Q on the capacitor describes this circuit?
 (A) $V_0 + QC - I^2R = 0$ (B) $V_0 - Q/C - IR = 0$ (C) $V_0^2 - Q^2/2C - I^2R = 0$
 (D) $V_0 - C(dQ/dt) - I^2R = 0$ (E) $Q/C - IR = 0$

28. Which of the following combinations of 4Ω resistors would dissipate 24 W when connected to a 12 Volt battery?

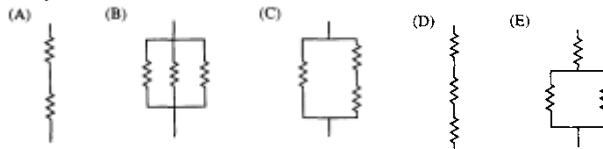

29. A wire of resistance R dissipates power P when a current I passes through it. The wire is replaced by another wire with resistance $3R$. The power dissipated by the new wire when the same current passes through it is
 (A) $P/9$ (B) $P/3$ (C) P (D) $3P$ (E) $6P$

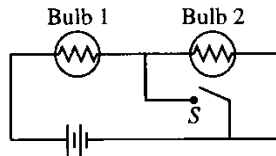

30. The circuit in the figure above contains two identical lightbulbs in series with a battery. At first both bulbs glow with equal brightness. When switch S is closed, which of the following occurs to the bulbs?
- | <u>Bulb 1</u> | <u>Bulb 2</u> |
|--------------------------|----------------------|
| (A) Goes out | Gets brighter |
| (B) Gets brighter | Goes out |
| (C) Gets brighter | Gets slightly dimmer |
| (D) Gets slightly dimmer | Gets brighter |
| (E) Nothing | Goes out |

31. A hair dryer is rated as 1200 W , 120 V . Its effective internal resistance is
 (A) 0.1Ω (B) 10Ω (C) 12Ω (D) 120Ω (E) 1440Ω

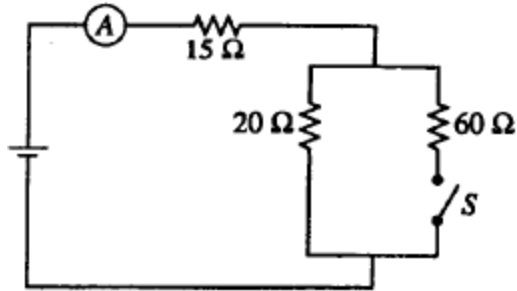

32. When the switch S is open in the circuit shown above, the reading on the ammeter A is 2.0 A. When the switch is closed, the reading on the ammeter is
- (A) doubled
 (B) increased slightly but not doubled
 (C) the same
 (D) decreased slightly but not halved
 (E) halved
33. Two conducting cylindrical wires are made out of the same material. Wire X has twice the length and twice the diameter of wire Y . What is the ratio R_x/R_y of their resistances?
- (A) $1/4$ (B) $1/2$ (C) 1 (D) 2 (E) 4

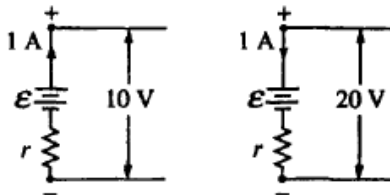

34. The figures above show parts of two circuits, each containing a battery of emf \mathcal{E} and internal resistance r . The current in each battery is 1 A, but the direction of the current in one battery is opposite to that in the other. If the potential differences across the batteries' terminals are 10 V and 20 V as shown, what are the values of \mathcal{E} and r ?
- (A) $\mathcal{E} = 5$ V, $r = 15$ Ω
 (B) $\mathcal{E} = 10$ V, $r = 100$ Ω
 (C) $\mathcal{E} = 15$ V, $r = 5$ Ω
 (D) $\mathcal{E} = 20$ V, $r = 10$ Ω
 (E) The values cannot be computed unless the complete circuits are shown.

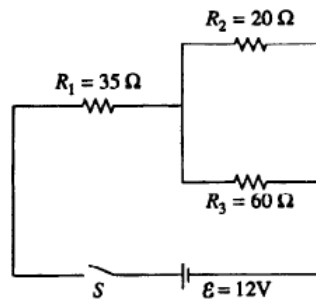

35. In the circuit shown above, the equivalent resistance of the three resistors is
- (A) 10.5 Ω (B) 15 Ω (C) 20 Ω (D) 50 Ω (E) 115 Ω

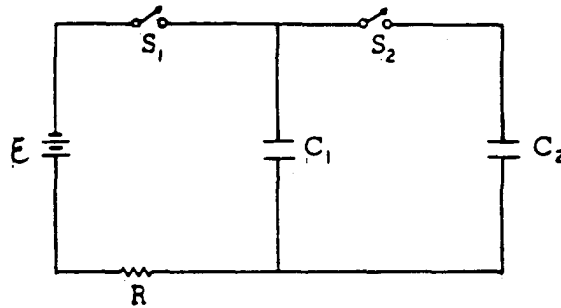

1975E2. In the diagram above, $V = 100$ volts; $C_1 = 12$ microfarads; $C_2 = 24$ microfarads; $R = 10$ ohms.

Initially, C_1 and C_2 are uncharged, and all switches are open.

- First, switch S_1 is closed. Determine the charge on C_1 when equilibrium is reached.
- Next S_1 is opened and afterward S_2 is closed. Determine the charge on C_1 when equilibrium is again reached.
- For the equilibrium condition of part (b), determine the voltage across C_1 .
- S_2 remains closed, and now S_1 is also closed. How much additional charge flows from the battery?

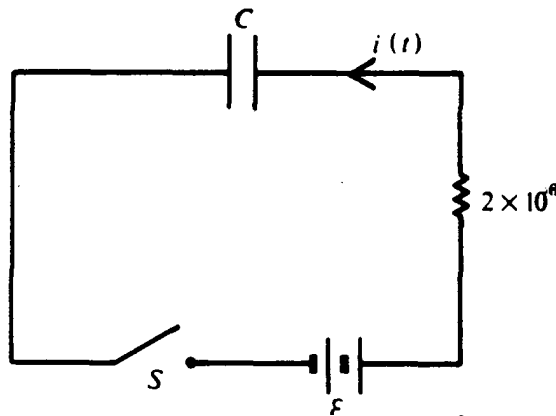

1983E2. The series circuit shown above contains a resistance $R = 2 \times 10^6$ ohms, a capacitor of unknown capacitance C , and a battery of unknown emf \mathcal{E} and negligible internal resistance. Initially the capacitor is uncharged and the switch S is open. At time $t = 0$ the switch S is closed. For $t > 0$ the current in the circuit is described by the equation:

$$i(t) = i_0 e^{-t/6} \text{ where } i_0 = 10 \text{ microamperes and } t \text{ is in seconds.}$$

- Determine the emf of the battery.
- By evaluating an appropriate integral, develop an expression for the charge on the right-hand plate of the capacitor as a function of time for $t > 0$.

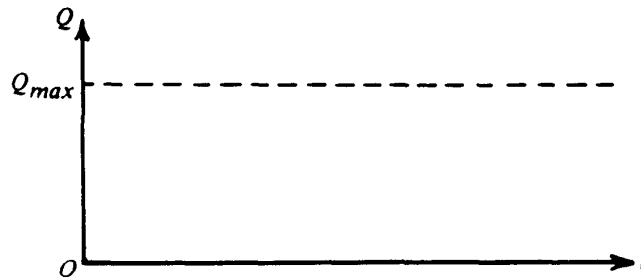

- On the axes below sketch a graph of the charge Q on the capacitor as a function of time t .
- Determine the capacitance C .

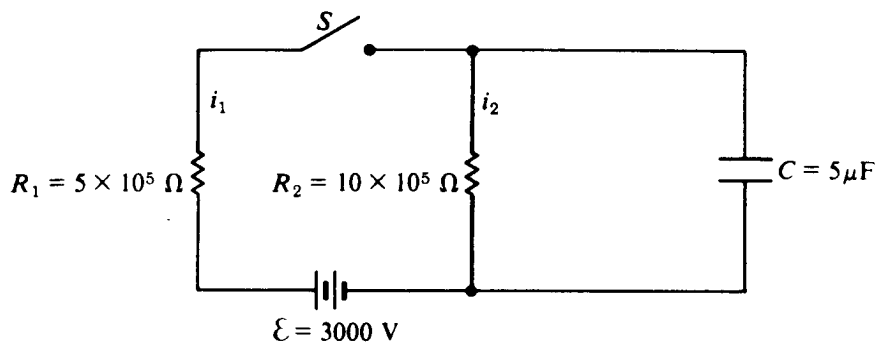

- 1985E2. In the circuit shown above, i_1 and i_2 are the currents through resistors R_1 and R_2 , respectively. V_1 , V_2 , and V_c are the potential differences across resistor R_1 , resistor R_2 , and capacitor C , respectively. Initially the capacitor is uncharged.
- Calculate the current i_1 immediately after switch S is closed.
 - On the axes below, sketch the potential difference V_2 as a function of time t .

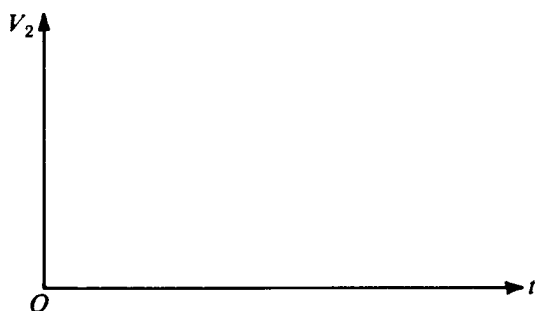

Assume switch S has been closed for a long time.

- Calculate the current i_2 .
- Calculate the charge Q on the capacitor.
- Calculate the energy U stored in the capacitor.

Now the switch S is opened.

- On the axes below, sketch the current i_2 as a function of time t and clearly indicate initial and final values.

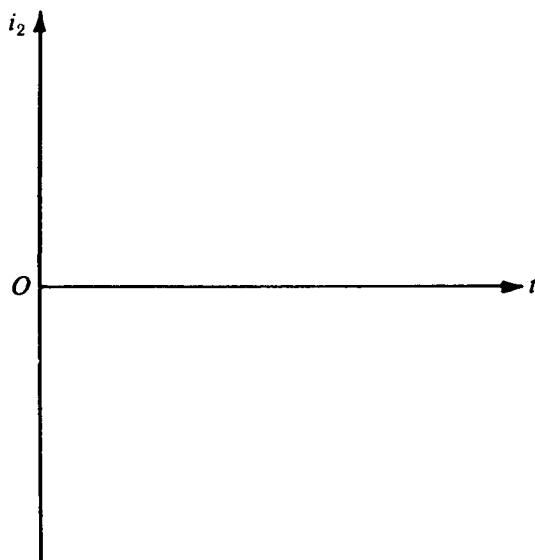

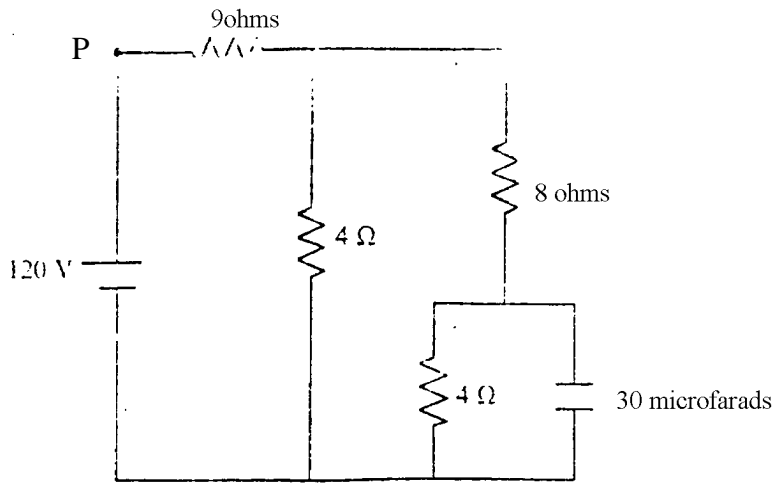

1988E2. In the circuit shown above, the battery has been connected for a long time so that the currents have steady values. Given these conditions, calculate each of the following

- The current in the 9-ohm resistor.
- The current in the 8-ohm resistor.
- The potential difference across the 30-microfarad capacitor.
- The energy stored in the 30-microfarad capacitor.

At some instant, the connection at point P fails, and the current in the 9-ohm resistor becomes zero.

- Calculate the total amount of energy dissipated in the 8-ohm resistor after the connection fails.

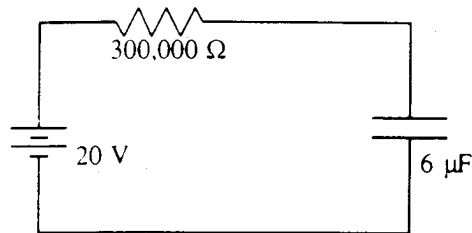

1989E3. A battery with an emf of 20 volts is connected in series with a resistor of 300,000 ohms and an air-filled parallel-plate capacitor of capacitance 6 microfarads.

- Determine the energy stored in the capacitor when it is fully charged.

The spacing between the capacitor plates is suddenly increased (in a time short compared to the time constant of the circuit) to four times its original value.

- Determine the work that must be done in increasing the spacing in this fashion.
- Determine the current in the resistor immediately after the spacing is increased.

After a long time, the circuit reaches a new static state.

- Determine the total charge that has passed through the battery.
- Determine the energy that has been added to the battery.

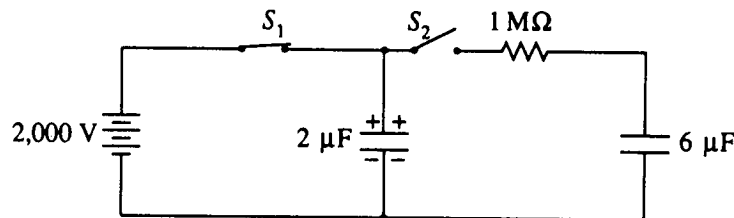

1992E2. The 2-microfarad (2×10^{-6} farad) capacitor shown in the circuit above is fully charged by closing switch S_1 and keeping switch S_2 open, thus connecting the capacitor to the 2,000-volt power supply.

- a. Determine each of the following for this fully charged capacitor.
 - i. The magnitude of the charge on each plate of the capacitor.
 - ii. The electrical energy stored in the capacitor.

At a later time, switch S_1 is opened. Switch S_2 is then closed, connecting the charged 2-microfarad capacitor to a $1 \times 10^6 \Omega$ resistor and a 6-microfarad capacitor, which is initially uncharged.

- b. Determine the initial current in the resistor the instant after switch S_2 is closed.

Equilibrium is reached after a long period of time.

- c. Determine the charge on the positive plate of each of the capacitors at equilibrium.
- d. Determine the total electrical energy stored in the two capacitors at equilibrium. If the energy is greater than the energy determined in part (a) ii., where did the increase come from? If the energy is less than the energy determined in part (a) ii., where did the electrical energy go?

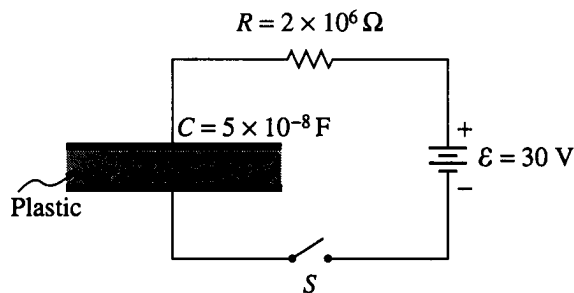

1995E2. A parallel-plate capacitor is made from two sheets of metal, each with an area of 1.0 square meter, separated by a sheet of plastic 1.0 millimeter (10^{-3} m) thick, as shown above. The capacitance is measured to be 0.05 microfarad (5×10^{-8} F).

- a. What is the dielectric constant of the plastic?
- b. The uncharged capacitor is connected in series with a resistor $R = 2 \times 10^6$ ohms, a 30-volt battery, and an open switch S , as shown above. The switch is then closed.
 - i. What is the initial charging current when the switch S is closed?
 - ii. What is the time constant for this circuit?
 - iii. Determine the magnitude and sign of the final charge on the bottom plate of the fully charged capacitor.
 - iv. How much electrical energy is stored in the fully charged capacitor?

After the capacitor is fully charged, it is carefully disconnected, leaving the charged capacitor isolated in space. The plastic sheet is then removed from between the metal plates. The metal plates retain their original separation of 1.0 millimeter.

- c. What is the new voltage across the plates?
- d. If there is now more energy stored in the capacitor, where did it come from? If there is now less energy, what happened to it?

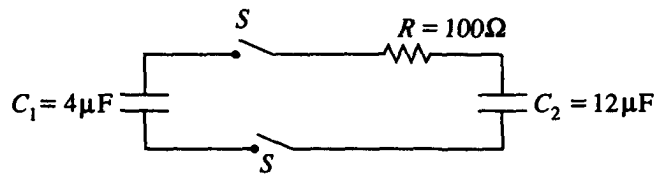

1996E2. Capacitors 1 and 2, of capacitance $C_1 = 4\ \mu\text{F}$ and $C_2 = 12\ \mu\text{F}$, respectively, are connected in a circuit as shown above with a resistor of resistance $R = 100\ \Omega$ and two switches. Capacitor 1 is initially charged to a voltage $V_0 = 50\ \text{V}$, and capacitor 2 is initially uncharged. Both of the switches S are then closed at time $t = 0$.

- What are the final charges on the positive plate of each of the capacitors 1 and 2 after equilibrium has been reached?
- Determine the difference between the initial and the final stored energy of the system after equilibrium has been reached.
- Write, but do not solve, an equation that, at any time after the switches are closed, relates the charge on capacitor C_1 , its time derivative (which is the instantaneous current in the circuit), and the parameters V_0 , R , C_1 , and C_2 .

The current in the resistor is given as a function of time by $I = I_0 e^{-t/\tau}$, where $I_0 = 0.5\ \text{A}$ and $\tau = 3 \times 10^{-4}\ \text{s}$.

- Determine the rate of energy dissipation in the resistor as an explicit function of time.
- How much energy is dissipated in the resistor from the instant the switch is closed to when equilibrium is reached?

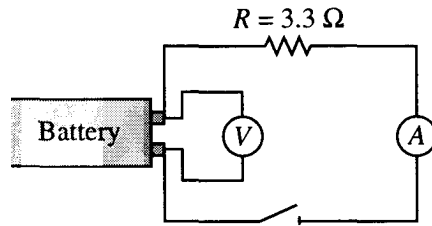

1997E1. A technician uses the circuit shown above to test prototypes of a new battery design. The switch is closed, and the technician records the current for a period of time. The curve that best fits the results is shown in the graph below.

The equation for this curve is $I = I_0 e^{-kt}$ where t is the time elapsed from the instant the switch is closed and I_0 and k are constants.

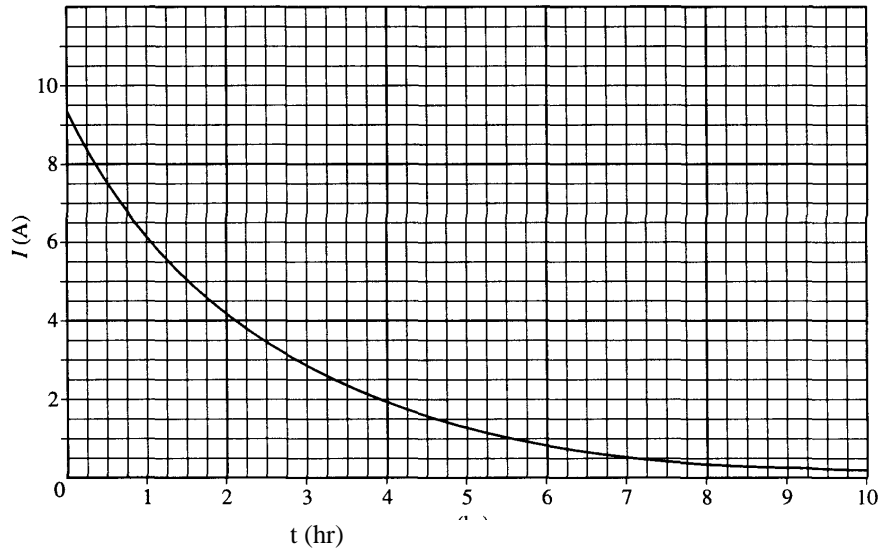

- Using the information in the graph, determine the potential difference V_0 across the resistor immediately after the switch is closed.
 - Would the open circuit voltage of the fresh battery have been less than, greater than, or equal to the value in part i? Justify your answer.
- Determine the value of k from this best-fit curve. Show your work and be sure to include units in your answer.
- Determine the following in terms of R , I_0 , k , and t .
 - The power delivered to the resistor at time $t = 0$
 - The power delivered to the resistor as a function of time t
 - The total energy delivered to the resistor from $t = 0$ until the current is reduced to zero

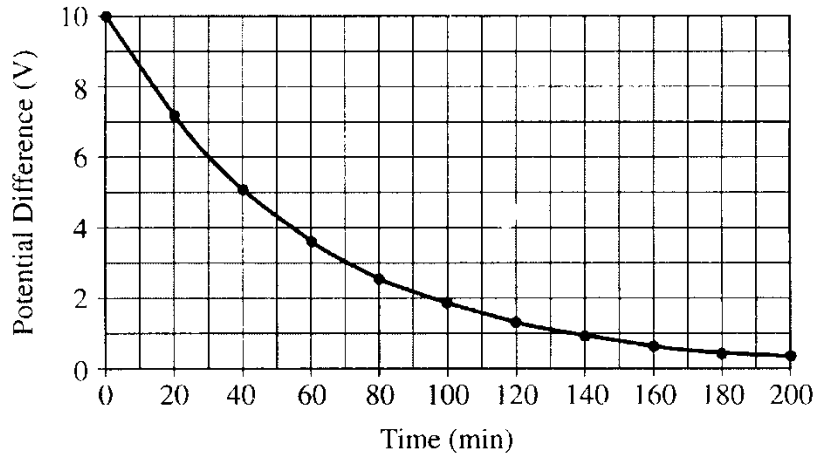

2001E2. You have been hired to determine the internal resistance of $8.0 \mu\text{F}$ capacitors for an electronic component manufacturer. (Ideal capacitors have an infinite internal resistance - that is, the material between their plates is a perfect insulator. In practice, however, the material has a very small, but nonzero, conductivity.) You cannot simply connect the capacitors to an ohmmeter, because their resistance is too large for an ohmmeter to measure. Therefore you charge the capacitor to a potential difference of 10 V with a battery, disconnect it from the battery and measure the potential difference across the capacitor every 20 minutes with an ideal voltmeter, obtaining the graph shown above.

- a. Determine the internal resistance of the capacitor.

The capacitor can be approximated as a parallel-plate capacitor separated by a 0.10 mm thick dielectric with $\kappa = 5.6$.

- b. Determine the approximate surface area of one of the capacitor "plates."
 c. Determine the resistivity of the dielectric.
 d. Determine the magnitude of the charge leaving the positive plate of the capacitor in the first 100 min.

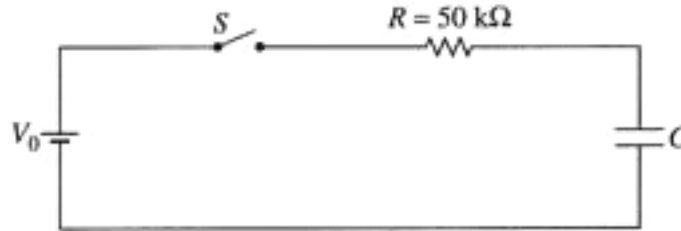

2002E2. Your engineering firm has built the RC circuit shown above. The current is measured for the time t after the switch is closed at $t = 0$ and the best-fit curve is represented by the equation $I(t) = 5.20 e^{-t/10}$, where I is in milliamperes and t is in seconds.

- Determine the value of the charging voltage V_0 predicted by the equation.
- Determine the value of the capacitance C predicted by the equation.
- The charging voltage is measured in the laboratory and found to be greater than predicted in part a.
 - Give one possible explanation for this finding.
 - Explain the implications that your answer to part i has for the predicted value of the capacitance.
- Your laboratory supervisor tells you that the charging time must be decreased. You may add resistors or capacitors to the original components and reconnect the RC circuit. In parts i and ii below, show how to reconnect the circuit, using either an additional resistor or a capacitor to decrease the charging time.
 - Indicate how a resistor may be added to decrease the charging time. Add the necessary resistor and connections to the following diagram.



- Instead of a resistor, use a capacitor. Indicate how the capacitor may be added to decrease the charging time. Add the necessary capacitor and connections to the following diagram.



2003E2. In the laboratory, you connect a resistor and a capacitor with unknown values in series with a battery of emf $\mathcal{E} = 12 \text{ V}$. You include a switch in the circuit. When the switch is closed at time $t = 0$, the circuit is completed, and you measure the current through the resistor as a function of time as plotted below.

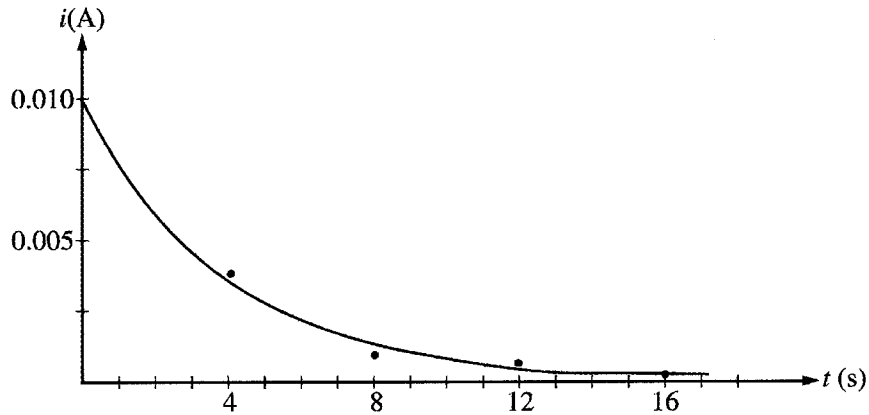

A data-fitting program finds that the current decays according to the equation $i(t) = \frac{\mathcal{E}}{R} e^{-t/4}$

- Using common symbols for the battery, the resistor, the capacitor, and the switch, draw the circuit that you constructed. Show the circuit before the switch is closed and include whatever other devices you need to measure the current through the resistor to obtain the above plot. Label each component in your diagram.
- Having obtained the curve shown above, determine the value of the resistor that you placed in this circuit.
- What capacitance did you insert in the circuit to give the result above?

You are now asked to reconnect the circuit with a new switch in such a way as to charge and discharge the capacitor. When the switch in the circuit is in position *A*, the capacitor is charging; and when the switch is in position *B*, the capacitor is discharging, as represented by the graph below of voltage V_C across the capacitor as a function of time

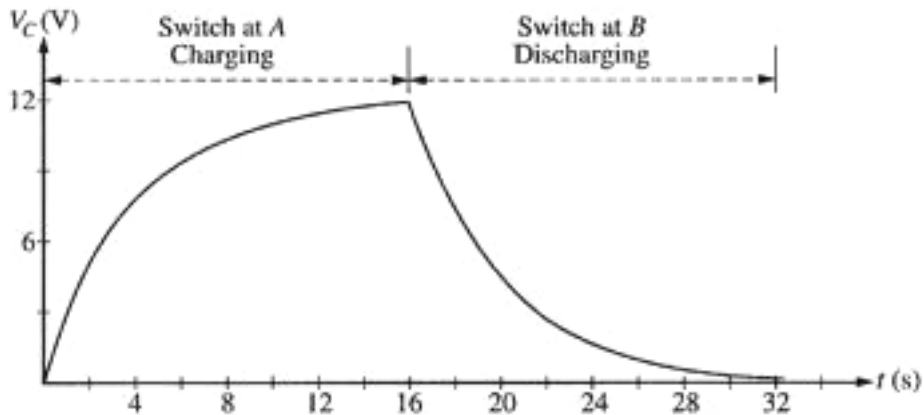

- Draw a schematic diagram of the RC circuit that you constructed that would produce the graph above. Clearly indicate switch positions *A* and *B* on your circuit diagram and include whatever other devices you need to measure the voltage across the capacitor to obtain the above plot. Label each component in your diagram.

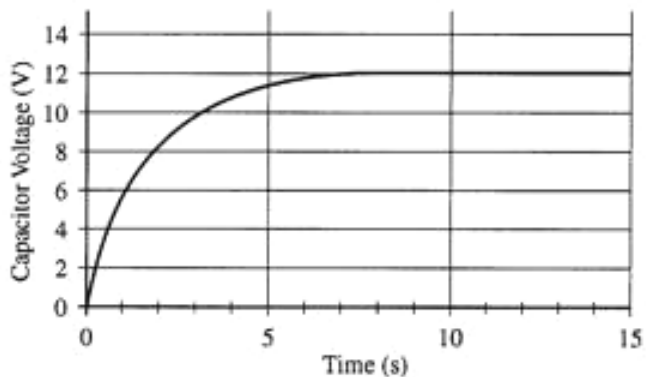
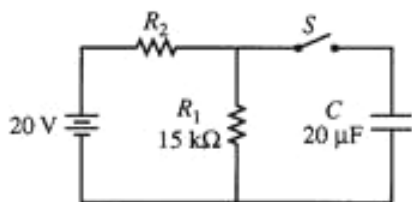

2004E2. In the circuit shown above left, the switch S is initially in the open position and the capacitor C is initially uncharged. A voltage probe and a computer (not shown) are used to measure the potential difference across the capacitor as a function of time after the switch is closed. The graph produced by the computer is shown above right. The battery has an emf of 20 V and negligible internal resistance. Resistor R_1 has a resistance of $15\text{ k}\Omega$ and the capacitor C has a capacitance of $20\text{ }\mu\text{F}$.

- Determine the voltage across resistor R_2 immediately after the switch is closed.
- Determine the voltage across resistor R_2 a long time after the switch is closed.
- Calculate the value of the resistor R_2 .
- Calculate the energy stored in the capacitor a long time after the switch is closed.
- On the axes below, graph the current in R_2 as a function of time from 0 to 15 s. Label the vertical axis with appropriate values.

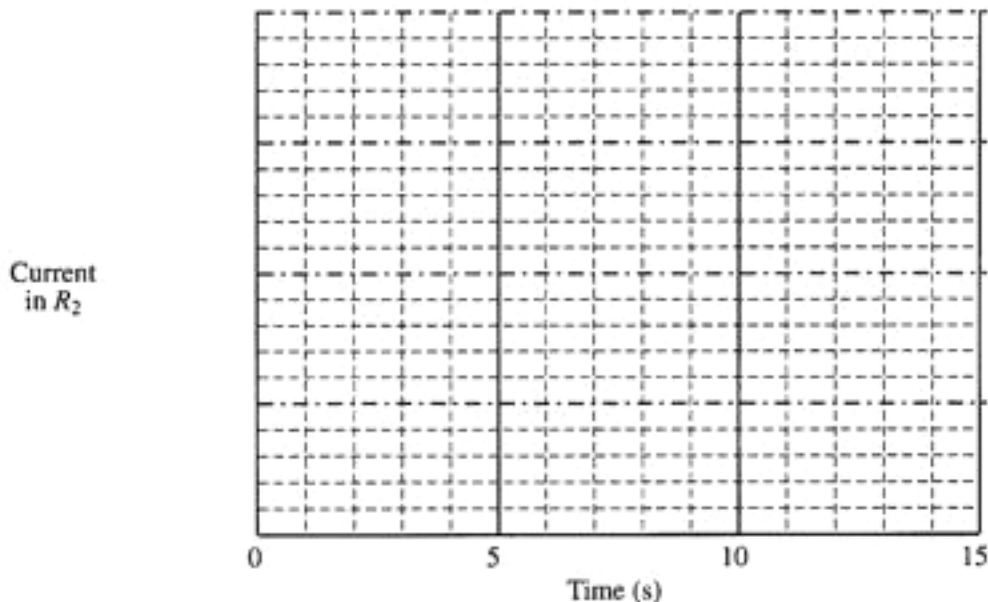

Resistor R_2 is removed and replaced with another resistor of lesser resistance. Switch S remains closed for a long time.

- Indicate below whether the energy stored in the capacitor is greater than, less than, or the same as it was with resistor R_2 in the circuit.

_____ Greater than _____ Less than _____ The same as

Explain your reasoning.

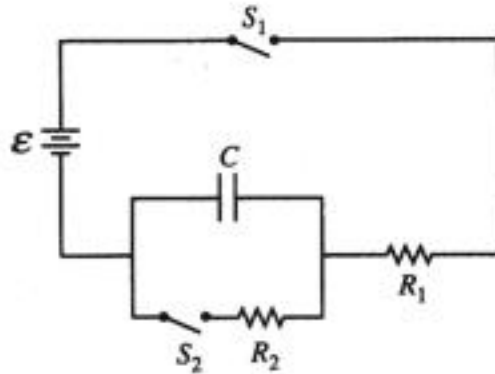

2006E2. The circuit above contains a capacitor of capacitance C , a power supply of emf \mathcal{E} , two resistors of resistances R_1 and R_2 , and two switches, S_1 and S_2 . Initially, the capacitor is uncharged and both switches are open. Switch S_1 then gets closed at time $t = 0$.

- Write a differential equation that can be solved to obtain the charge on the capacitor as a function of time t .
- Solve the differential equation in part a. to determine the charge on the capacitor as a function of time.

Numerical values for the components are given as follows:

$$\mathcal{E} = 12\text{V}$$

$$C = 0.060\text{ F}$$

$$R_1 = R_2 = 4700\ \Omega$$

- Determine the time at which the capacitor has a voltage 4.0 V across it.

After switch S_1 has been closed for a long time, switch S_2 gets closed at a new time $t = 0$.

- On the axes below, sketch graphs of the current I_1 in R_1 versus time and of the current I_2 in R_2 versus time, beginning when switch S_2 is closed at new time $t = 0$. Clearly label which graph is I_1 and which is I_2 .

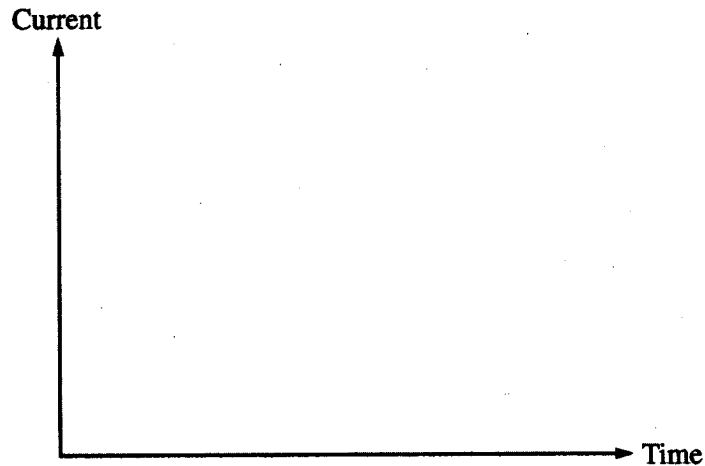

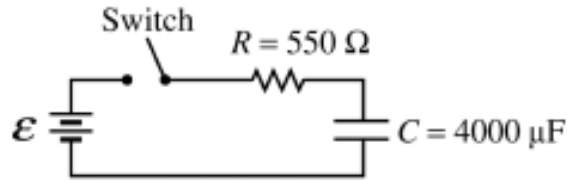

2007E1. A student sets up the circuit above in the lab. The values of the resistance and capacitance are as shown, but the constant voltage \mathcal{E} delivered by the ideal battery is unknown. At time $t = 0$, the capacitor is uncharged and the student closes the switch. The current as a function of time is measured using a computer system, and the following graph is obtained.

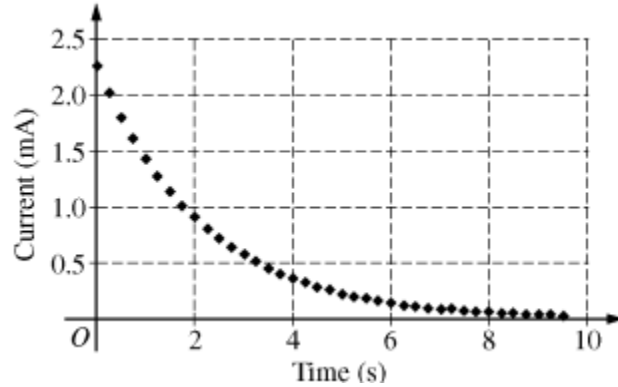

- Using the data above, calculate the battery voltage \mathcal{E} .
- Calculate the voltage across the capacitor at time $t = 4.0$ s.
- Calculate the charge on the capacitor at $t = 4.0$ s.
- On the axes below, sketch a graph of the charge on the capacitor as a function of time.

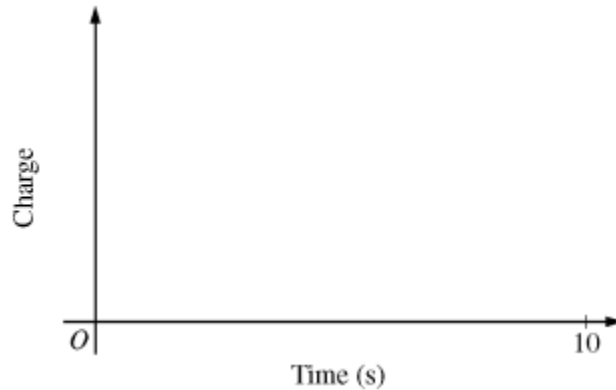

- Calculate the power being dissipated as heat in the resistor at $t = 4.0$ s.
- The capacitor is now discharged, its dielectric of constant $\kappa = 1$ is replaced by a dielectric of constant $\kappa = 3$, and the procedure is repeated. Is the amount of charge on one plate of the capacitor at $t = 4.0$ s now greater than, less than, or the same as before? Justify your answer.

_____ Greater than _____ Less than _____ The same

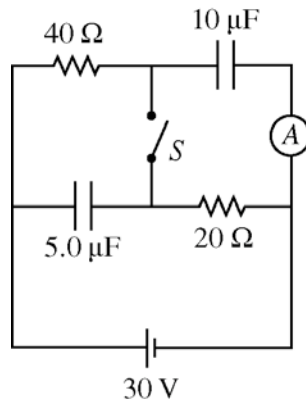

2010E2. In the circuit illustrated above, switch S is initially open and the battery has been connected for a long time.

- What is the steady-state current through the ammeter?
- Calculate the charge on the 10 mF capacitor.
- Calculate the energy stored in the 5.0 mF capacitor.

The switch is now closed, and the circuit comes to a new steady state.

- Calculate the steady-state current through the battery.
- Calculate the final charge on the 5.0 mF capacitor.
- Calculate the energy dissipated as heat in the $40 \text{ } \Omega$ resistor in one minute once the circuit has reached steady state

ANSWERS - AP Physics C Multiple Choice Practice – Circuits

<u>Solution</u>	<u>Answer</u>
1. $P = V^2/R$	E
2. $\int idt$ is charge, $\int Edx$ is potential difference. Q/V is capacitance	D
3. The current through R is found using the junction rule at the top junction, where 1 A + 2 A enter giving $I = 3$ A. Now utilize Kirchhoff's loop rule through the left or right loops: (left side) $+ 16$ V $- (1$ A) $(4$ $\Omega) - (3$ A) $R = 0$ giving $R = 4$ Ω	B
4. $R = \rho L/A$. Greatest resistance is the longest, narrowest resistor.	B
5. Summing the potential differences from left to right gives $V_T = -12$ V $- (2$ A) $(2$ $\Omega) = -16$ V. It is possible for $V_T > \mathcal{E}$.	E
6. When a current of 0.1 A passes through the circuit element connected to the galvanometer, we want 10^{-3} A through the "galvanometer" and $0.1 - 10^{-3} = 0.099$ A to flow through, bypassing the coil. For full scale deflection we need a voltage of $(99$ $\Omega)(10^{-3}$ A) = .099 V so we need a resistance of $(0.099$ V) $/(0.099$ A) = 1 Ω in parallel	D
7. Current is greatest where resistance is least. The resistances are, in order, 1 Ω , 2 Ω , 4 Ω , 2 Ω and 6 Ω .	A
8. See above	E
9. Least power is for the greatest resistance ($P = \mathcal{E}^2/R$)	E
10. When the switch is closed, the circuit behaves as if the capacitor were just a wire and all the potential of the battery is across the resistor. As the capacitor charges, the voltage changes over to the capacitor over time, eventually making the current (and the potential difference across the resistor) zero and the potential difference across the capacitor equal to the emf of the battery.	A
11. See above	A
12. See above	B
13. The time constant is $R \times C$. To increase it, we need to increase either R and/or C. In parallel, capacitors add their capacitances.	A
14. Since these resistors are in series, they must have the same current.	E
15. $V_T = \mathcal{E} - Ir$	C
16. When charging a capacitor, the voltage across the capacitor (and its charge) grows as $(1 - e^{-t})$ while the voltage across the resistor (and the current) decays as e^{-t}	A
17. Kirchhoff's junction rule applied at point X gives 2 A = $I + 1$ A, so the current in the middle wire is 1 A. Summing the potential differences through the middle wire from X to Y gives -10 V $- (1$ A) $(2$ $\Omega) = -12$ V	D
18. $P = I^2R$ and $R = \rho L/A$ giving $P \propto \rho L/d^2$	C
19. Utilizing Kirchhoff's loop rule starting at the upper left and moving clockwise: $-(2$ A) $(0.3$ $\Omega) + 12$ V $- 6$ V $- (2$ A) $(0.2$ $\Omega) - (2$ A) $(R) - (2$ A) $(1.5$ $\Omega) = 0$	A
20. Summing the potential differences: -6 V $- (2$ A) $(0.2$ $\Omega) - (2$ A) $(1$ $\Omega) = -8.4$ V	C
21. Energy = $Pt = I^2Rt$	C

22. When the switch is closed, the circuit behaves as if the capacitor were just a wire, shorting out the resistor on the right. B
23. When the capacitor is fully charged, the branch with the capacitor is “closed” to current, effectively removing it from the circuit for current analysis. A
24. Total resistance = $\mathcal{E}/I = 25 \Omega$. Resistance of the 30Ω and 60Ω resistors in parallel = 20Ω adding the internal resistance in series with the external circuit gives $R_{\text{total}} = 20 \Omega + r = 25 \Omega$ C
25. $P = V^2/R$ and if V is constant $P \propto 1/R$ A
26. For the ammeter to read zero means the junctions at the ends of the ammeter have the same potential. For this to be true, the potential drops across the 1Ω and the 2Ω resistor must be equal, which means the current through the 1Ω resistor must be twice that of the 2Ω resistor. This means the resistance of the upper branch (1Ω and 3Ω) must be $\frac{1}{2}$ that of the lower branch (2Ω and R) giving $1 \Omega + 3 \Omega = \frac{1}{2}(2 \Omega + R)$ E
27. Kirchhoff’s loop rule ($V = Q/C$ for a capacitor) B
28. To dissipate 24 W means $R = V^2/P = 6 \Omega$. The resistances, in order, are: 8Ω , $4/3 \Omega$, $8/3 \Omega$, 12Ω and 6Ω E
29. $P = I^2R$ D
30. Closing the switch short circuits Bulb 2 causing no current to flow to it. Since the bulbs were originally in series, this decreases the total resistance and increases the total current, making bulb 1 brighter. B
31. $P = V^2/R$ C
32. Closing the switch reduces the resistance in the right side from 20Ω to 15Ω , making the total circuit resistance decrease from 35Ω to 30Ω , a slight decrease, causing a slight increase in current. For the current to double, the total resistance must be cut in half. B
33. $R = \rho L/A \propto L/d^2$ where d is the diameter. $R_x/R_y = L_x/d_x^2 \div L_y/d_y^2 = (2L_y)d_y^2/[L_y(2d_y)^2] = \frac{1}{2}$ B
34. Summing the potential differences from bottom to top:
left circuit: $-(1 \text{ A})r + \mathcal{E} = 10 \text{ V}$
right circuit: $+(1 \text{ A})r + \mathcal{E} = 20 \text{ V}$, solve simultaneous equations C
35. The equivalent resistance of the 20Ω and the 60Ω in parallel is 15Ω , added to the 35Ω resistor in series gives $15 \Omega + 35 \Omega = 50 \Omega$ D

1975E2

- $Q = C\mathcal{E} = 12 \mu\text{F} \times 100 \text{ V} = 1200 \mu\text{C}$
- Connecting the two capacitors puts them in parallel with the same voltage so $V_1 = V_2$ and $V = Q/C$ which gives $Q_1/C_1 = Q_2/C_2$ or $Q_1/12 = Q_2/24$ and $Q_2 = 2Q_1$. We also know the total charge is conserved so $Q_1 + Q_2 = 1200 \mu\text{C}$ so we have $Q_1 + 2Q_1 = 1200 \mu\text{C}$ so $Q_1 = 400 \mu\text{C}$
- $V = Q/C = 33.3 \text{ V}$
- When the battery is reconnected, both capacitors charge to a potential difference of 100 V each. The total charge is then $Q = Q_1 + Q_2 = (C_1 + C_2)V = 3600 \mu\text{C}$ making the *additional* charge from the battery $2400 \mu\text{C}$.

1983E2

- Initially there is no potential drop across the capacitor so $\mathcal{E} = i_0 R = 20 \text{ Volts}$
-

$$Q = \int i dt = \int_0^t i_0 e^{-\frac{t}{6}} dt = -6i_0 e^{-\frac{t}{6}} - (-6i_0 e^0) = 6i_0(1 - e^{-\frac{t}{6}})$$

-

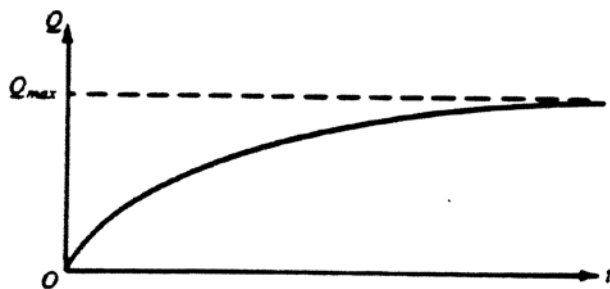

- For charging a capacitor, the time constant is RC . The numerical value of the time constant is 6 seconds so $C = 6/R = 3 \times 10^{-6} \text{ F}$

1985E2

- Immediately after the switch is closed, the capacitor begins charging with current flowing to the capacitor as if it was just a wire. This short circuits R_2 making the total effective resistance of the circuit $5 \times 10^6 \Omega$ and the total current $\mathcal{E}/R_{\text{eff}} = 0.006 \text{ A}$

-

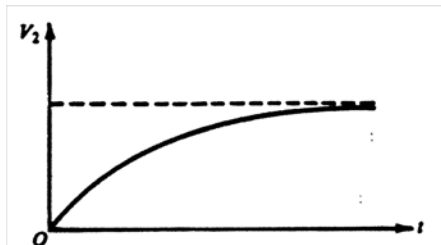

- When the capacitor is fully charged, no current flows through that branch and the circuit behaves as a simple series circuit with a total resistance of $15 \times 10^6 \Omega$ and a total current of $\mathcal{E}/R = 0.002 \text{ A}$
- The voltage across the capacitor is equal to the voltage across the $10 \text{ M}\Omega$ resistor as they are in parallel. $V_C = V_{10\text{M}} = IR = 2000 \text{ V}$ and $Q = CV = 0.01 \text{ C}$
- $U_C = \frac{1}{2} CV^2 = 10 \text{ J}$

f.

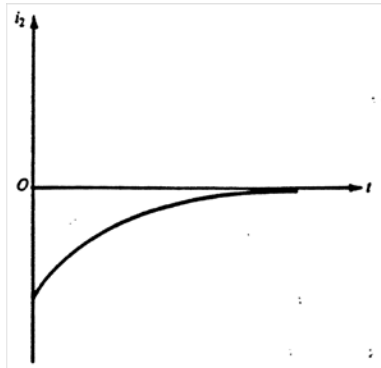

1988E2

- In their steady states, no current flows through the capacitor so the effective resistance of the branch on the right is $8\ \Omega + 4\ \Omega = 12\ \Omega$. This is in parallel with the $4\ \Omega$ resistor making their effective resistance $(12 \times 4)/(12 + 4) = 3\ \Omega$. Adding the $9\ \Omega$ resistor in the main branch gives a total circuit resistance of $12\ \Omega$ and a total current of $\mathcal{E}/R = 10\ \text{A}$. This is the current in the $9\ \Omega$ resistor as it is in the main branch.
- With $10\ \text{A}$ across the $9\ \Omega$ resistor, the potential drop across it is $90\ \text{V}$, leaving $30\ \text{V}$ across the two parallel branches on the right. With $30\ \text{V}$ across the $12\ \Omega$ effective resistance in the right branch, we have a current through that branch (including the $8\ \Omega$ resistor) of $V/R = 2.5\ \text{A}$
- $V_C = V_4 = IR = (2.5\ \text{A})(4\ \Omega) = 10\ \text{V}$
- $U_C = \frac{1}{2} CV^2 = 1500\ \mu\text{J}$
- Considering the capacitor as a battery, the equivalent circuit consists of a $4\ \Omega$ branch and a branch with a $4\ \Omega$ and $8\ \Omega$ resistor in series. The current from the discharging capacitor divides in the ratio of $1:3$, with the $8\ \Omega$ resistor getting $\frac{1}{4}$ of the total and within the series branch, the $8\ \Omega$ resistor will receive $\frac{2}{3}$ of the branch voltage so the fraction of the total energy dissipated in the $8\ \Omega$ resistor is $(\frac{1}{4})(\frac{2}{3})U_{\text{total}} = 250\ \mu\text{J}$

1989E3

- When charged, the potential difference across the capacitor is $20\ \text{V}$. $U_C = \frac{1}{2} CV^2 = 1200\ \mu\text{J}$
- Given that the charge is initially unchanged, the work done is the change in the energy stored in the capacitor. Increasing the distance between plates to 4 times the initial value causes the capacitance to decrease to $\frac{1}{4}$ its initial value ($C \propto 1/d$). Since $Q_i = Q_f$ we have $C_i V_i = C_f V_f$ so $V_f = 4V_i$
 $W = \Delta U_C = \frac{1}{2} C_f V_f^2 - \frac{1}{2} C_i V_i^2 = \frac{1}{2} (\frac{1}{4} C)(4V)^2 - \frac{1}{2} CV^2 = 3600\ \mu\text{J}$
- After the spacing is increased, the capacitor acts as a battery with a voltage of $4V = 80\ \text{V}$ with its emf opposite that of the $20\ \text{V}$ battery making the effective voltage supplied to the circuit $80\ \text{V} - 20\ \text{V} = 60\ \text{V}$.
 $I = \mathcal{E}_{\text{eff}}/R = 2 \times 10^{-4}\ \text{A}$
- The charge on the capacitor initially was $Q = CV = 120\ \mu\text{C}$ and after the plates have been separated and a new equilibrium is reached $Q = (\frac{1}{4}C)V = 30\ \mu\text{C}$ so the charge that flowed back through the battery is $120\ \mu\text{C} - 30\ \mu\text{C} = 90\ \mu\text{C}$
- For the battery $U = Q_{\text{added}}V = 1800\ \mu\text{J}$

1992E2

- a. i. $Q = CV = 4 \times 10^{-3} \text{ C}$
ii. $U_C = \frac{1}{2} CV^2 = 4 \text{ J}$
- b. When the switch is closed, there is no charge on the $6 \mu\text{F}$ capacitor so the potential difference across the resistor equals that across the $2 \mu\text{F}$ capacitor, or 2000 V and $I = V/R = 2 \times 10^{-3} \text{ A}$
- c. In equilibrium, charge is no longer moving so there is no potential difference across the resistor therefore the capacitors have the same potential difference. $V_2 = V_6$ gives $Q_2/C_2 = Q_6/C_6$ giving $Q_6 = 3Q_2$ and since total charge is conserved we have $Q_2 + Q_6 = Q_2 + 3Q_2 = 4Q_2 = 4 \times 10^{-3} \text{ C}$ so $Q_2 = 1 \times 10^{-3} \text{ C}$ and $Q_6 = 3 \times 10^{-3} \text{ C}$
- d. $U_C = U_2 + U_6 = Q_2^2/2C_2 + Q_6^2/2C_6 = 1 \text{ J}$. This is less than in part a. ii. Part of the energy was converted to heat in the resistor.
-

1995E2

- a. $C = \kappa \epsilon_0 A/d$ so $\kappa = Cd/\epsilon_0 A = 5.65$
- b. i. When the switch is closed, the voltage across the capacitor is zero thus all the voltage appears across the resistor and $I = \mathcal{E}/R = 1.5 \times 10^{-5} \text{ A}$
ii. $\tau = RC = 0.1 \text{ seconds}$
iii. When fully charged, the current has stopped flowing and all the voltage now appears across the capacitor and $Q = CV = 1.5 \times 10^{-6} \text{ C}$ and since the bottom plate is connected to the negative terminal of the battery the charge on that plate is also negative.
iv. $U_C = \frac{1}{2} CV^2 = 2.25 \times 10^{-5} \text{ J}$
- c. Since the capacitor is isolated, the charge on it remains the same. Removing the plastic reduces the capacitance to $C' = \epsilon_0 A/d = C_{\text{original}}/\kappa$ and $V = Q/C' = 170 \text{ V}$
- d. $U' = Q^2/2C' = Q^2/2(C/\kappa) = \kappa(Q^2/2C) = \kappa U > U_{\text{original}}$. The increase came from the work that had to be done to remove the plastic from the capacitor.
-

1996E2

- a. The initial charge on C_1 is $Q = CV_0 = 200 \mu\text{C}$. In equilibrium, charge is no longer moving so there is no potential difference across the resistor therefore the capacitors have the same potential difference. $V_1 = V_2$ gives $Q_1/C_1 = Q_2/C_2$ giving $Q_2 = 3Q_1$ and since total charge is conserved we have $Q_1 + Q_2 = Q_1 + 3Q_1 = 4Q_1 = 200 \mu\text{C}$ so $Q_1 = 50 \mu\text{C}$ and $Q_2 = 150 \mu\text{C}$
- b. $\Delta U = U_f - U_i = (Q_1^2/2C_1 + Q_2^2/2C_2) - \frac{1}{2} C_1 V_0^2 = -3750 \mu\text{J}$
- c. Kirchhoff's loop rule: $\mathcal{E} - IR - V_2 = 0$ with the following substitutions
 $\mathcal{E} = V_1 = Q_1/C_1$
 $I = \text{discharge rate of } C_1 = -dQ_1/dt$
 $V_2 = Q_2/C_2$ where $Q_2 = Q_0 - Q_1 = V_0 C_1 - Q_1$ all of which gives
 $Q_1/C_1 + (dQ_1/dt)R - (V_0 C_1 - Q_1)/C_2 = 0$
- d.
$$P = I^2 R = \left(I_0 e^{-\frac{t}{\tau}} \right)^2 R = I_0^2 R e^{-\frac{2t}{\tau}} \text{ or } 25 e^{-\frac{t}{1.5 \times 10^{-4}}}$$
- e. The energy dissipated is equal to the difference in stored energy calculated in part (b): $\Delta U = 3750 \mu\text{J}$
(You could also integrate $P \text{ dt}$)
-

1997E1

- a. i. $V = IR$, from the graph $I_0 \approx 9.3 \text{ A}$ so $V = (9.3 \text{ A})(3.3 \Omega) \approx 31 \text{ V}$
 ii. The battery's open circuit voltage would be greater as a real battery has internal resistance so when it is connected in a circuit only part of the open circuit voltage appears across the external components
- b. Taking the natural log of the expression for current gives $\ln(I) = \ln(I_0) - kt \ln(e)$, or $\ln(I/I_0) = -kt$
 $k = \ln(I/I_0)/t$ and take a reading from the graph (for example 7.5 A at 0.5 h) gives $k = 0.4 \text{ hr}^{-1}$
- c. i. $P = I^2R$ at $t=0$ gives $P = I_0^2R$
 ii. substituting the expression for current gives $P = I_0^2R e^{-2kt}$
 iii.

$$U = \int P dt = \int_0^{\infty} I_0^2 R e^{-2kt} dt = I_0^2 R \left(-\frac{1}{2k} \right) e^{-2kt} \Big|_0^{\infty} = -\frac{I_0^2 R}{2k} (0 - 1) = \frac{I_0^2 R}{2k}$$

2001E2

- a. One method is to use the equation $V = V_0 e^{-t/RC}$ and substitute values from the graph,
 e.g. $V_0 = 10 \text{ V}$, and $V = 2 \text{ V}$ at $t = 100 \text{ min}$
 $2 = 10e^{-(6000 \text{ s})/R(8\mu\text{F})}$ giving $R = 4.7 \times 10^8 \Omega$
- b. $C = \kappa\epsilon_0 A/d$ so $A = Cd/\kappa\epsilon_0 = 16 \text{ m}^2$
- c. $R = \rho L/A$ giving $\rho = RA/L = 7.2 \times 10^{13} \Omega\text{-m}$
- d. One method is to use $\Delta Q = C\Delta V = (8 \times 10^{-6} \text{ F})(10 \text{ V} - 2 \text{ V}) = 64 \mu\text{C}$
 Another method is to integrate $I dt$

2002E2

- a. $V_0 = I(0)R = (5.2 \times 10^{-3} \text{ A})(50 \times 10^3 \Omega) = 260 \text{ V}$
- b. at $t = \infty$ the capacitor is fully charged so the total voltage drop occurs across it. We can integrate the current to find the total charge stored
 $Q = \int_0^{\infty} I dt = \int_0^{\infty} 5.2 \text{ mA } e^{-t/10} dt = -(10)(5.2 \text{ mA})e^{-t/10} \Big|_0^{\infty} = 52 \text{ mC}$
 Now $C = Q/V_0 = 200 \mu\text{F}$
 Another method is to realize $\tau = 10$ seconds and $\tau = RC$
- c. i. There is resistance in the connecting wires and within the power supply
 ii. The predicted value of the capacitance is too high since the actual V_0 should be higher and $C = Q/V_0$
- d. i.

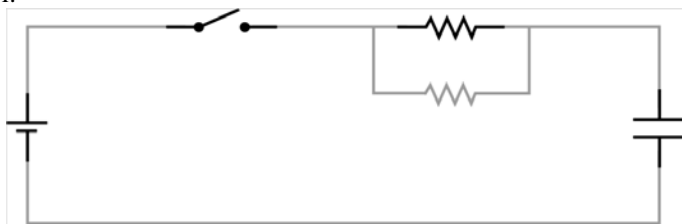

ii.

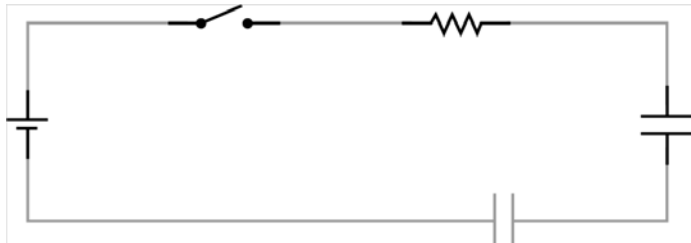

2003E2

a.

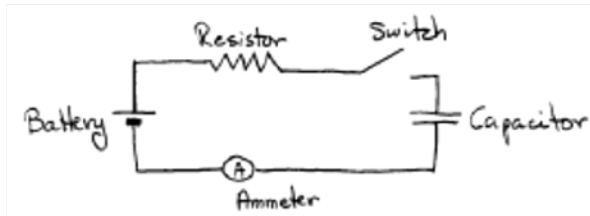

- b. $R = V/I = (12 \text{ V})/(0.01 \text{ A}) = 1200 \Omega$
 c. $\tau = RC$ so $C = \tau/R = (4 \text{ s})/(1200 \Omega) = 3.3 \times 10^{-3} \text{ F}$
 d.

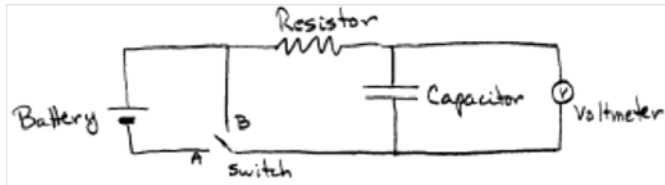

2004E2

- a. Once the switch is closed, $V_{R1} = V_C$ and $V_C = 0$ (initially uncharged) therefore all the voltage drop occurs across R_2 so $V_{R2} = 20 \text{ V}$
 b. From the graph, the maximum voltage across the capacitor (and thus also R_1) is 12 V , the remaining voltage drop occurs across R_2 so $V_{R2} = 8 \text{ V}$
 c. A long time after the switch is closed $I_1 = I_2$ and $I_1 = V_1/R_1 = (12 \text{ V})/(15 \text{ k}\Omega) = (8 \text{ V})/R_2$ so $R_2 = 10 \text{ k}\Omega$
 d. $U = \frac{1}{2} CV^2 = \frac{1}{2}(20 \mu\text{F})(12 \text{ V})^2 = 1.44 \times 10^{-3} \text{ J}$
 e.

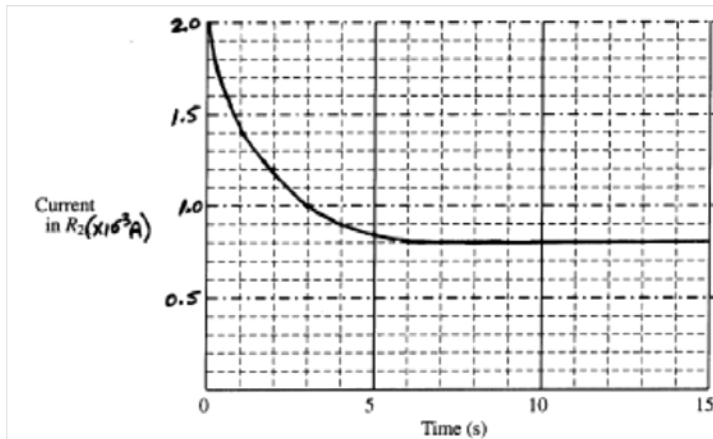

- f. The energy would be greater. Consider the circuit a long time after the switch is closed, when there is no current in the capacitor. If R_2 is replaced with a smaller resistance, then the total resistance decreases. This results in a larger current through the resistors. Therefore, the voltage across R_1 , and thus across the capacitor, increases.

2006E2

- a. From Kirchhoff's loop rule $\mathcal{E} - V_R - V_C = 0$
 $\mathcal{E} - IR_1 - q/C = 0$ where $I = dq/dt$
 $\mathcal{E} - R_1 dq/dt - q/C = 0$

b.

$$\mathcal{E} - \frac{dq}{dt} R_1 - \frac{q}{C} = 0$$

$$\frac{dq}{\mathcal{E}C - q} = \frac{dt}{R_1 C}$$

$$\int_0^q \frac{dq}{\mathcal{E}C - q} = \int_0^t \frac{dt}{R_1 C}$$

$$\ln(q - \mathcal{E}C) \Big|_0^q = -\frac{t}{R_1 C} \Big|_0^t$$

$$\ln(q - \mathcal{E}C) - \ln(-\mathcal{E}C) = \ln \frac{q - \mathcal{E}C}{-\mathcal{E}C} = -\frac{t}{R_1 C}$$

$$\frac{q - \mathcal{E}C}{-\mathcal{E}C} = e^{-\frac{t}{R_1 C}}$$

$$q - \mathcal{E}C = -\mathcal{E}C e^{-\frac{t}{R_1 C}}$$

$$q = \mathcal{E}C \left(1 - e^{-\frac{t}{R_1 C}} \right)$$

c. $q = CV$

$$\mathcal{E}C(1 - e^{-t/RC}) = CV \text{ gives } t = R_1 C \ln \left(\frac{\mathcal{E}}{\mathcal{E} - V} \right) = (4700 \Omega)(0.06 \text{ F}) \ln (12 \text{ V}/(12 \text{ V} - 4\text{V})) = 114 \text{ seconds}$$

d.

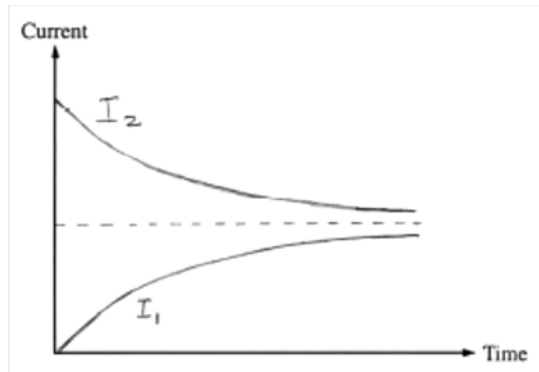

2007E1

- a. Since $V_C = 0$ at $t = 0$, $\mathcal{E} = IR$. From the graph I is approximately 2.25 mA giving $\mathcal{E} = 1.24 \text{ V}$
 b. At $t = 4 \text{ s}$, $I = 0.35 \text{ mA}$ and $V_C = \mathcal{E} - IR = 1.24 \text{ V} - (0.35 \text{ mA})(550 \Omega) = 1.05 \text{ V}$
 c. $Q = CV = 4200 \mu\text{C}$
 d.

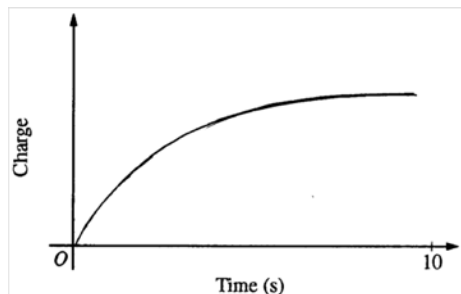

- e. $P = I^2 R = (0.35 \text{ mA})^2 (550 \Omega) = 6.7 \times 10^{-5} \text{ W}$
- f. Greater. C increases with a larger dielectric constant, but so does the time constant so we check
 $Q(\kappa=3)/Q(\kappa=1) = \kappa C \mathcal{E} (1 - e^{-t/\kappa\tau}) / C \mathcal{E} (1 - e^{-t/\kappa\tau}) = 3(1 - e^{-0.61}) / (1 - e^{-1.82}) = 1.63$
-

2010E2

- a. With a capacitor in each branch, the steady state current is zero.
- b. $Q = CV$ and each branch has 30 V (and the resistors have no potential drop with no current)
 $Q = (10 \mu\text{F})(30 \text{ V}) = 300 \mu\text{C}$
- c. $U = \frac{1}{2} CV^2 = \frac{1}{2} (5 \mu\text{F})(30 \text{ V})^2 = 2250 \mu\text{J}$
- d. With the switch closed, the capacitors are charged, but there is a steady current which winds its way through both resistors in series. $R_T = 20 \Omega + 40 \Omega = 60 \Omega$ and $V = IR$ so $I = 0.5 \text{ A}$
- e. The voltage across the 5 μF capacitor is identical to the voltage across the 40 Ω resistor, which is $(0.5 \text{ A})(40 \Omega) = 20 \text{ V}$. So $Q = CV = 100 \mu\text{C}$
- f. $P = I^2 R = (0.5 \text{ A})^2 (40 \Omega) = 10 \text{ W}$
 $E = Pt = (10 \text{ W})(60 \text{ s}) = 600 \text{ J}$
-

Chapter 10

Magnetism

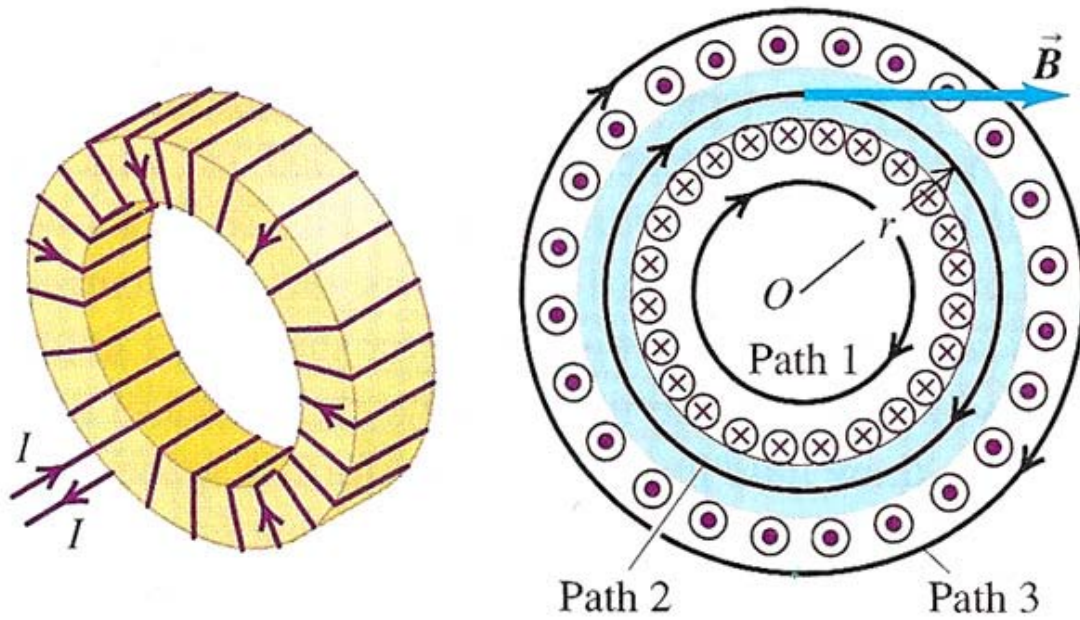

SECTION A – Magnetostatics

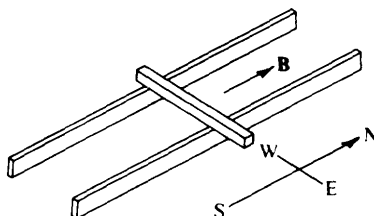

- The ends of a metal bar rest on two horizontal north-south rails as shown above. The bar may slide without friction freely with its length horizontal and lying east and west as shown above. There is a magnetic field parallel to the rails and directed north. A battery is connected between the rails and causes the electrons in the bar to drift to the east. The resulting magnetic force on the bar is directed
 (A) north (B) south (C) east (D) west (E) vertically
- A charged particle is projected with its initial velocity parallel to a uniform magnetic field. The resulting path is a
 (A) spiral
 (B) parabolic arc
 (C) circular arc
 (D) straight line parallel to the field
 (E) straight line perpendicular to the field

Questions 3-4



A proton traveling with speed v enters a uniform electric field of magnitude E , directed parallel to the plane of the page, as shown in the figure above. There is also a magnetic force on the proton that is in the direction opposite to that of the electric force.

- Which of the following is a possible direction for the magnetic field?
 (A) (B) (C) (D) \odot (directed out of the page) (E) \otimes (directed into the page)
- If e represents the magnitude of the proton charge, what minimum magnitude of the magnetic field could balance the electric force on the proton?
 (A) E/v (B) eE/v (C) vE (D) eE (E) evE



- At point X a charged particle has a kinetic energy of 9 microjoules (μJ). It follows the path shown above from X to Y through a region in which there is an electric field and a magnetic field. At Y the particle has a kinetic energy of 11 μJ . What is the work done by the magnetic field on the particle?
 (A) 11 μJ (B) 2 μJ (C) - 2 μJ (D) - 11 μJ (E) None of the above

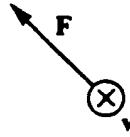

6. In a region of space there is a uniform \mathbf{B} field in the plane of the page but no \mathbf{E} field. A positively charged particle with velocity \mathbf{v} directed into the page is subject to a force \mathbf{F} in the plane of the page as shown above. Which of the following vectors best represents the direction of \mathbf{B} ?

- (A) (B) (C) (D) (E)

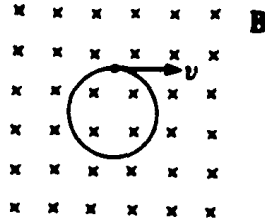

7. A negatively charged particle in a uniform magnetic field \mathbf{B} moves with constant speed v in a circular path of radius r , as shown above. Which of the following graphs best represents the radius r as a function of the magnitude of \mathbf{B} , if the speed v is constant?

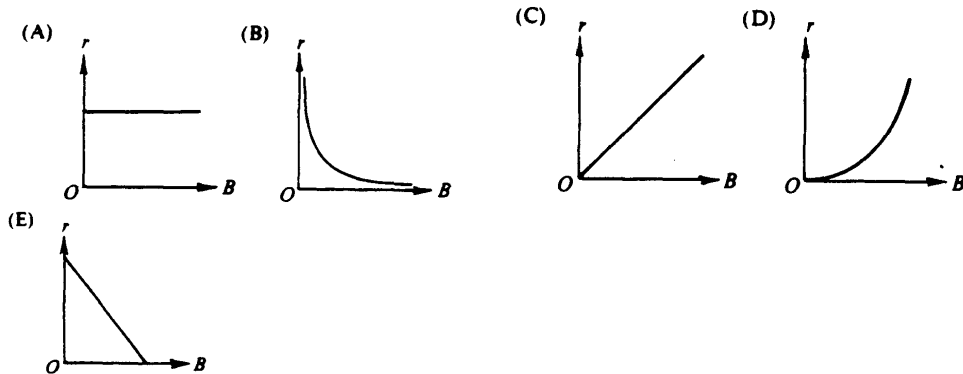

8. Which of the following equations implies that it is impossible to isolate a magnetic pole?

(A) $\oint \mathbf{E} \cdot d\mathbf{A} = q / \epsilon_0$

(B) $\oint \mathbf{E} \cdot d\mathbf{l} = -d\phi_E / dt$

(C) $\oint \mathbf{B} \cdot d\mathbf{A} = 0$

(D) $\oint \mathbf{B} \cdot d\mathbf{l} = \mu_0 i + \mu_0 \epsilon_0 d\phi_E / dt$

(E) None of the above

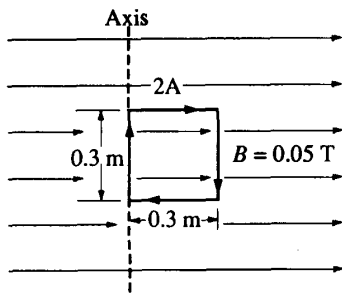

9. A square loop of wire 0.3 meter on a side carries a current of 2 amperes and is located in a uniform 0.05-tesla magnetic field. The left side of the loop is aligned along and attached to a fixed axis. When the plane of the loop is parallel to the magnetic field in the position shown above, what is the magnitude of the torque exerted on the loop about the axis?
- A) 0.00225 Nm B) 0.0090 Nm C) 0.278 Nm D) 1.11 Nm E) 111 Nm

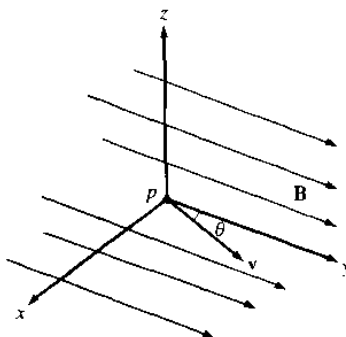

10. A uniform magnetic field \mathbf{B} is parallel to the xy -plane and in the $+y$ -direction, as shown above. A proton p initially moves with velocity \mathbf{v} in the xy -plane at an angle θ to the magnetic field and the y -axis. The proton will subsequently follow what kind of path?
- (A) A straight-line path in the direction of \mathbf{v} (B) A circular path in the xy -plane
 (C) A circular path in the yz -plane (D) A helical path with its axis parallel to the y -axis
 (E) A helical path with its axis parallel to the z -axis

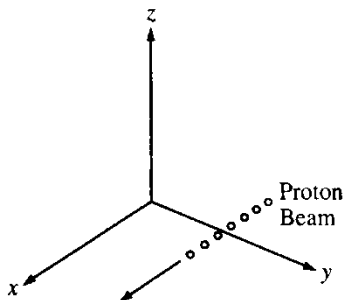

11. A beam of protons moves parallel to the x -axis in the positive x -direction, as shown above, through a region of crossed electric and magnetic fields balanced for zero deflection of the beam. If the magnetic field is pointed in the positive y -direction, in what direction must the electric field be pointed?
- (A) Positive y -direction (B) Positive z -direction (C) Negative x -direction (D) Negative y -direction
 (E) Negative z -direction

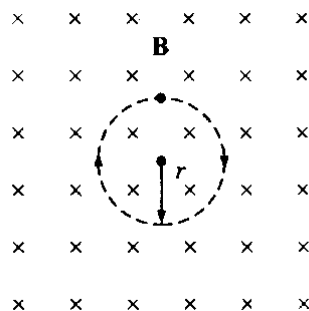

12. A negatively charged particle in a uniform magnetic field B moves in a circular path of radius r , as shown above. Which of the following graphs best depicts how the frequency of revolution f of the particle depends on the radius r ?

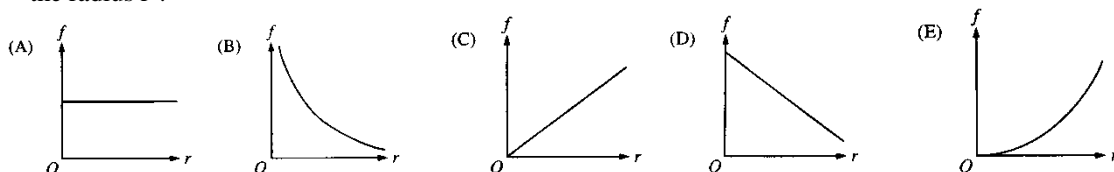

Questions 13-14

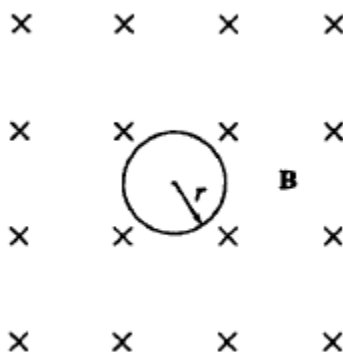

A particle of charge $+e$ and mass m moves with speed v perpendicular to a uniform magnetic field B directed into the page. The path of the particle is a circle of radius r , as shown above.

13. Which of the following correctly gives the direction of motion and the equation relating v and r ?

<u>Direction</u>	<u>Equation</u>
(A) Clockwise	$eBr = mv$
(B) Clockwise	$eBr = mv^2$
(C) Counterclockwise	$eBr = mv$
(D) Counterclockwise	$eBr = mv^2$
(E) Counterclockwise	$eBr^2 = mv^2$

14. The period of revolution of the particle is

(A) mr/eB (B) $\sqrt{m/eB}$ (C) $2\pi m/eB$ (D) $2\pi\sqrt{m/eB}$ (E) $2\pi\sqrt{mr/eB}$

15. A charged particle can move with constant velocity through a region containing both an electric field and a magnetic field only if the

- (A) electric field is parallel to the magnetic field
 (B) electric field is perpendicular to the magnetic field
 (C) electric field is parallel to the velocity vector
 (D) magnetic field is parallel to the velocity vector
 (E) magnetic field is perpendicular to the velocity vector

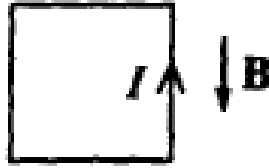

16. A square loop of wire carrying a current I is initially in the plane of the page and is located in a uniform magnetic field B that points toward the bottom of the page, as shown above. Which of the following shows the correct initial rotation of the loop due to the force exerted on it by the magnetic field?

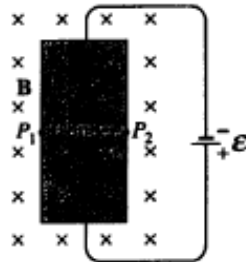
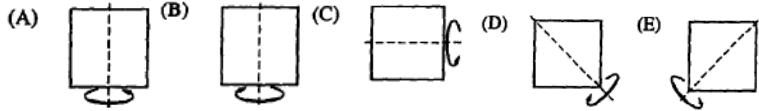

17. A sheet of copper in the plane of the page is connected to a battery as shown above, causing electrons to drift through the copper toward the bottom of the page. The copper sheet is in a magnetic field B directed into the page. P_1 and P_2 are points at the edges of the strip. Which of the following statements is true?
- (A) P_1 is at a higher potential than P_2 .
 - (B) P_2 is at a higher potential than P_1 .
 - (C) P_1 and P_2 are at equal positive potential.
 - (D) P_1 and P_2 are at equal negative potential.
 - (E) Current will cease to flow in the copper sheet.

SECTION B – Biot Savart and Ampere’s Law

18. Two long, parallel wires, fixed in space, carry currents I_1 and I_2 . The force of attraction has magnitude F . What currents will give an attractive force of magnitude $4F$?
- (A) $2I_1$ and $\frac{1}{2}I_2$
 (B) I_1 and $\frac{1}{4}I_2$
 (C) $\frac{1}{2}I_1$ and $\frac{1}{2}I_2$
 (D) $2I_1$ and $2I_2$
 (E) $4I_1$ and $4I_2$
19. A solid cylindrical conductor of radius R carries a current I uniformly distributed throughout its interior. Which of the following graphs best represents the magnetic field intensity as a function of r , the radial distance from the axis of the cylinder

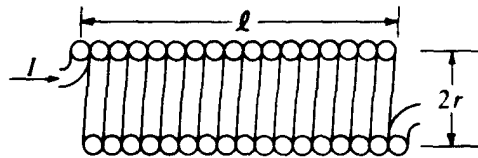
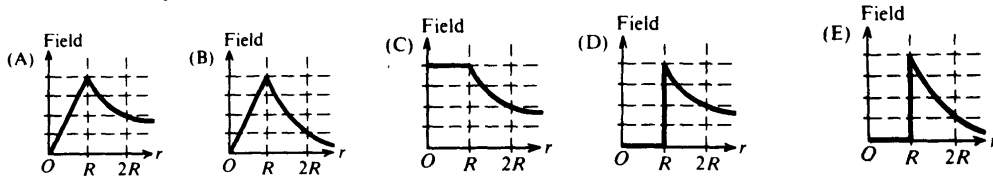

20. The cross section above shows a long solenoid of length l and radius r consisting of N closely wound turns of wire. When the current in the wire is I , the magnetic field within this solenoid has magnitude B_0 . A solenoid with the same number of turns N , length l , and current I , but with radius $2r$, would have a magnetic field of magnitude most nearly equal to
- (A) $B_0/4$ (B) $B_0/2$ (C) B_0 (D) $2B_0$ (E) $4B_0$

$P \bullet$

Wire \otimes

\otimes Wire

21. Two very long parallel wires carry equal currents in the same direction into the page, as shown above. At point P , which is 10 centimeters from each wire, the magnetic field is
- (A) zero
 (B) directed into the page
 (C) directed out of the page
 (D) directed to the left
 (E) directed to the right

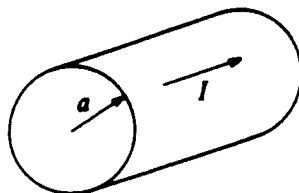

22. A current I , uniformly distributed over the cross section of a long cylindrical conductor of radius a , is directed as shown above. Which of the following graphs best represents the intensity B of the magnetic field as a function of the distance r from the axis of the cylinder?

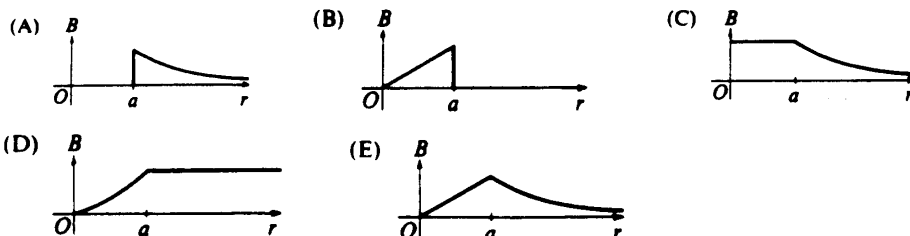

- Questions 23-24 relate to the two long parallel wires shown below. Initially the wires are a distance d apart and each has a current i directed into the page. The force per unit length on each wire has magnitude F_0 .

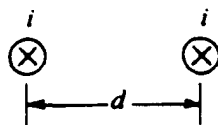

23. The direction of the force on the right-hand wire due to the current in the left-hand wire is
 (A) to the right (B) to the left (C) upward in the plane of the page
 (D) downward in the plane of the page (E) into the page
24. The wires are moved apart to a separation $2d$ and the current in each wire is increased to $2i$. The new force per unit length on each wire is
 (A) $F_0/4$ (B) $F_0/2$ (C) F_0 (D) $2F_0$ (E) $4F_0$

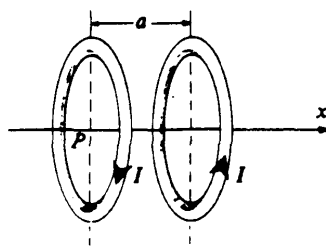

25. Two identical parallel conducting rings have a common axis and are separated by a distance a , as shown above. The two rings each carry a current I , but in opposite directions. At point P , the center of the ring on the left the magnetic field due to these currents is
 (A) zero (B) in the plane perpendicular to the x -axis (C) directed in the positive x -direction
 (D) directed in the negative x -direction (E) none of the above

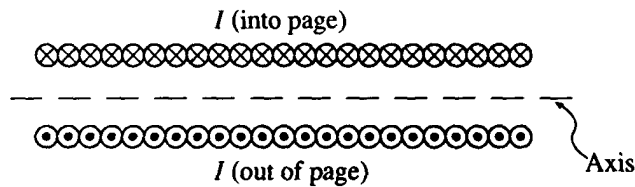

26. A cross section of a long solenoid that carries current I is shown above. All of the following statements about the magnetic field B inside the solenoid are correct EXCEPT:
- A) B is directed to the left.
 - B) An approximate value for the magnitude of B may be determined by using Ampere's law.
 - C) The magnitude of B is proportional to the current I .
 - D) The magnitude of B is proportional to the number of turns of wire per unit length.
 - E) The magnitude of B is proportional to the distance from the axis of the solenoid.

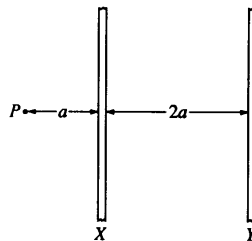

27. Two long parallel wires are a distance $2a$ apart, as shown above. Point P is in the plane of the wires and a distance a from wire X . When there is a current I in wire X and no current in wire Y , the magnitude of the magnetic field at P is B_0 . When there are equal currents I in the same direction in both wires, the magnitude of the magnetic field at P is
- A) $2B_0/3$ B) B_0 C) $10B_0/9$ D) $4B_0/3$ E) $2B_0$

Questions 28-29

A narrow beam of protons produces a current of 1.6×10^{-3} A. There are 10^9 protons in each meter along the beam.

28. Of the following, which is the best estimate of the average speed of the protons in the beam?
- (A) 10^{-15} m/s (B) 10^{-12} m/s (C) 10^{-7} m/s (D) 10^7 m/s (E) 10^{12} m/s
29. Which of the following describes the lines of magnetic field in the vicinity of the beam due to the beam's current?
- (A) Concentric circles around the beam (B) Parallel to the beam (C) Radial and toward the beam
 - (D) Radial and away from the beam (E) There is no magnetic field.

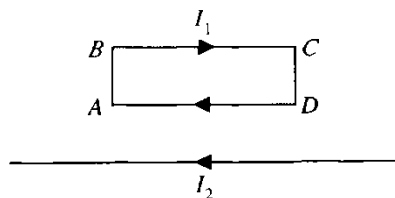

30. A rigid, rectangular wire loop $ABCD$ carrying current I_1 lies in the plane of the page above a very long wire carrying current I_2 as shown above. The net force on the loop is
- (A) toward the wire (B) away from the wire (C) toward the left (D) toward the right (E) zero

31. In which of the following cases does there exist a nonzero magnetic field that can be conveniently determined by using Ampere's law?
- (A) Outside a point charge that is at rest
 (B) Inside a stationary cylinder carrying a uniformly distributed charge
 (C) Inside a very long current-carrying solenoid
 (D) At the center of a current-carrying loop of wire
 (E) Outside a square current-carrying loop of wire
32. A wire of radius R has a current I uniformly distributed across its cross-sectional area. Ampere's law is used with a concentric circular path of radius r , with $r < R$, to calculate the magnitude of the magnetic field B at a distance r from the center of the wire. Which of the following equations results from a correct application of Ampere's law to this situation?
- (A) $B(2\pi r) = \mu_0 I$ (B) $B(2\pi r) = \mu_0 I(r^2/R^2)$ (C) $B(2\pi r) = 0$ (D) $B(2\pi R) = \mu_0 I$ (E) $B(2\pi R) = \mu_0 I(r^2/R^2)$
33. Two parallel wires, each carrying a current I , repel each other with a force F . If both currents are doubled, the force of repulsion is
- A) $2F$ (B) $2\sqrt{2} F$ (C) $4F$ (D) $4\sqrt{2} F$ (E) $8F$

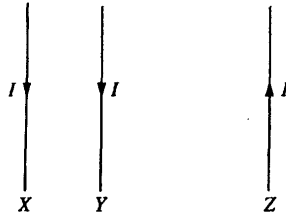

34. The currents in three parallel wires, X, Y, and Z, each have magnitude I and are in the directions shown above. Wire Y is closer to wire X than to wire Z. The magnetic force on wire Y is
- (A) zero (B) into the page (C) out of the page (D) toward the bottom of the page (E) toward the left

SECTION C – Induction and Inductance

35. In each of the following situations, a bar magnet is aligned along the axis of a conducting loop. The magnet and the loop move with the indicated velocities. In which situation will the bar magnet NOT induce a current in the conducting loop?

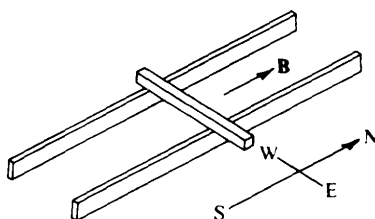
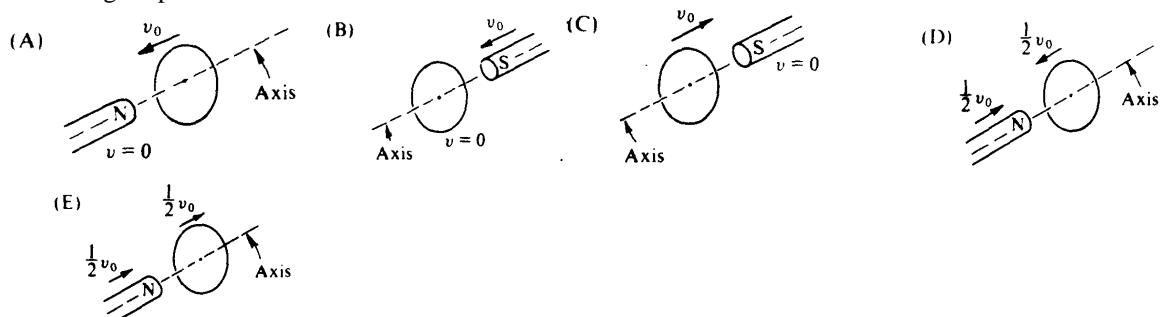

36. The ends of a metal bar rest on two horizontal north-south rails as shown above. The bar may slide without friction freely with its length horizontal and lying east and west as shown above. There is a magnetic field parallel to the rails and directed north. If the bar is pushed northward on the rails, the electromotive force induced in the bar as a result of the magnetic field will
- be directed upward
 - be zero
 - produce a westward current
 - produce an eastward current
 - stop the motion of the bar

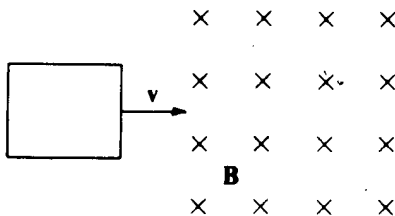

37. A loop of wire is pulled with constant velocity v to the right through a region of space where there is a uniform magnetic field B directed into the page, as shown above. The magnetic force on the loop is
- directed to the left both as it enters and as it leaves the region
 - directed to the right both as it enters and as it leaves the region
 - directed to the left as it enters the region and to the right as it leaves
 - directed to the right as it enters the region and to the left as it leaves
 - zero at all times

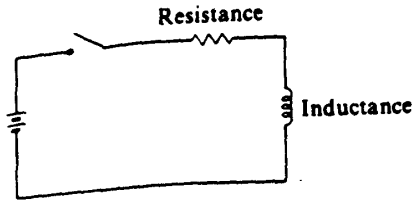

38. At time $t = 0$ the switch is closed in the circuit shown above. Which of the following graphs best describes the potential difference V , across the resistance as a function of time t ?

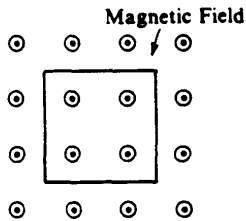
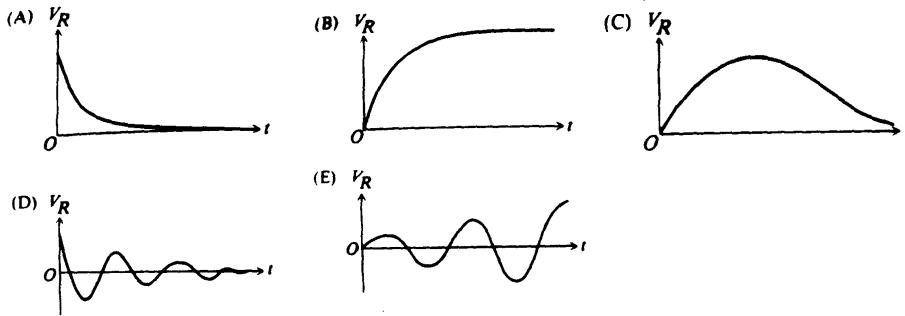

39. A square loop of wire of side 0.5 meter and resistance 10^{-2} ohm is located in a uniform magnetic field of intensity 0.4 tesla directed out of the page as shown above. The magnitude of the field is decreased to zero at a constant rate in 2 seconds. As the field is decreased, what are the magnitude and direction of the current in the loop?

- (A) Zero (B) 5 A, counterclockwise (C) 5 A, clockwise
 (D) 20 A, counterclockwise (E) 20 A, clockwise

40. If R is 1 ohm and L is 1 henry, then L/R is

- (A) 1 volt (B) 1 farad (C) 1 ampere (D) 1 coulomb (E) 1 second

Questions 41-42 refer to the diagram below of two conducting loops having a common axis.

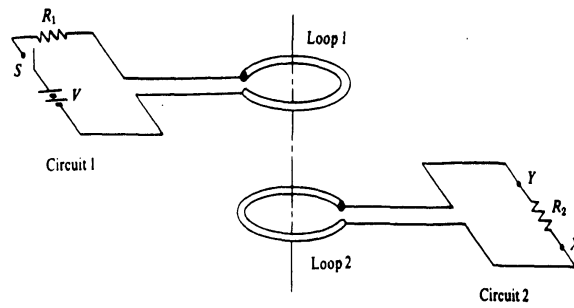

41. After the switch S is closed, the current through resistor R_2 is
- from point X to point Y
 - from point Y to point X
 - zero at all times
 - oscillating with decreasing amplitude
 - oscillating with constant amplitude
42. After the switch S has been closed for a very long time, the currents in the two circuits are
- zero in both circuits
 - zero in circuit 1 and V/R_2 in circuit 2
 - V/R_1 in circuit 1 and zero in circuit 2
 - V/R_1 in circuit 1 and V/R_2 in circuit 2
 - oscillating with constant amplitude in both circuits
43. A large parallel-plate capacitor is being charged and the magnitude of the electric field between the plates of the capacitor is increasing at the rate dE/dt . Which of the following statements is correct about the magnetic field in the region between the plates of the charging capacitor?
- It is parallel to the electric field.
 - Its magnitude is directly proportional to dE/dt .
 - Its magnitude is inversely proportional to dE/dt .
 - Nothing about the field can be determined unless the charging current is known.
 - Nothing about the field can be determined unless the instantaneous electric field is known.

Questions 44-46 relate to the following circuit in which the switch S has been open for a long time.

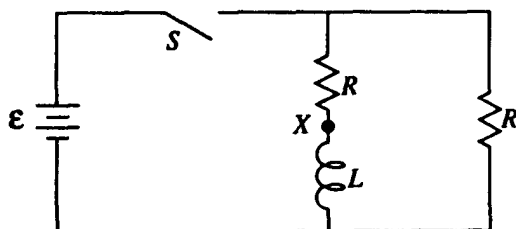

44. What is the instantaneous current at point X immediately after the switch is closed?
 A) 0 B) \mathcal{E}/R C) $\mathcal{E}/2R$ D) \mathcal{E}/RL E) $\mathcal{E}L/2R$
45. When the switch has been closed for a long time what is the energy stored in the inductor?
 A) $L\mathcal{E}/2R$ B) $L\mathcal{E}^2/2R^2$ C) $L\mathcal{E}^2/4R^2$ D) $LR^2/2\mathcal{E}^2$ E) $\mathcal{E}^2R^2/4L$
46. After the switch has been closed for a long time, it is opened at time $t = 0$. Which of the following graphs best represents the subsequent current i at point X as a function of time t ?

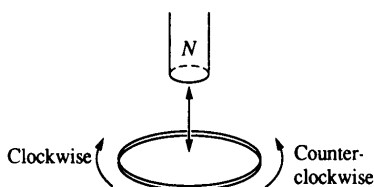
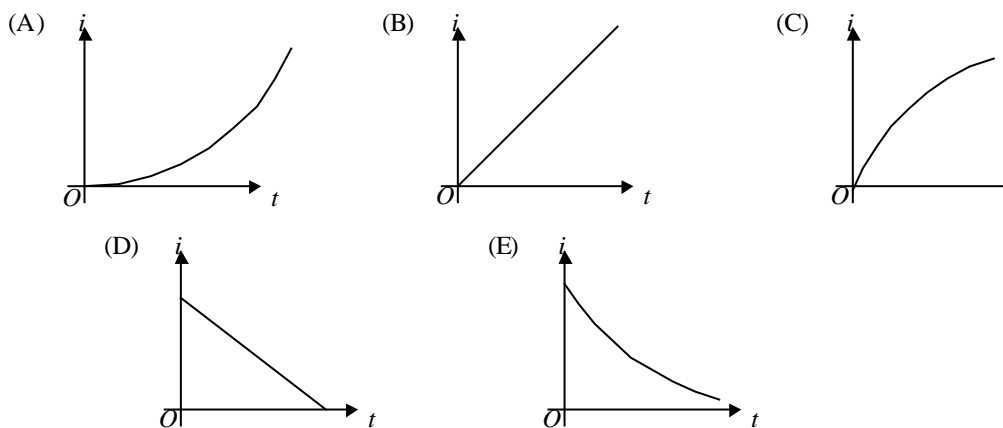

47. In the figure above, the north pole of the magnet is first moved down toward the loop of wire, then withdrawn upward. As viewed from above, the induced current in the loop is
 A) always clockwise with increasing magnitude
 B) always clockwise with decreasing magnitude
 C) always counterclockwise with increasing magnitude
 D) always counterclockwise with decreasing magnitude
 E) first counterclockwise, then clockwise

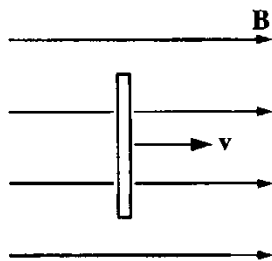

48. A vertical length of copper wire moves to the right with a steady velocity v in the direction of a constant horizontal magnetic field B as shown above. Which of the following describes the induced charges on the ends of the wire?

<u>Top End</u>	<u>Bottom End</u>
(A) Positive	Negative
(B) Negative	Positive
(C) Negative	Zero
(D) Zero	Negative
(E) Zero	Zero

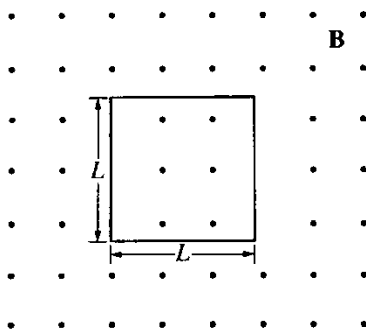

49. A square wire loop with side L and resistance R is held at rest in a uniform magnetic field of magnitude B directed out of the page, as shown above. The field decreases with time t according to the equation $B = a - bt$, where a and b are positive constants. The current I induced in the loop is
 (A) zero (B) aL^2/R , clockwise (C) aL^2/R , counterclockwise
 (D) bL^2/R , clockwise (E) bL^2/R , counterclockwise

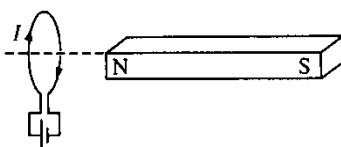

50. A bar magnet and a wire loop carrying current I are arranged as shown above. In which direction, if any, is the force on the current loop due to the magnet?
 (A) Toward the magnet (B) Away from the magnet (C) Toward the top of the page
 (D) Toward the bottom of the page (E) There is no force on the current loop.

B (into page)

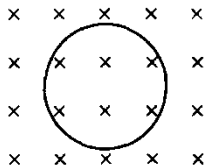

51. A wire loop of area A is placed in a time-varying but spatially uniform magnetic field that is perpendicular to the plane of the loop, as shown above. The induced emf in the loop is given by $\mathcal{E} = bAt^{1/2}$, where b is a constant. The time varying magnetic field could be given by

(A) $\frac{1}{2}bAt^{-1/2}$ (B) $\frac{1}{2}bt^{-1/2}$ (C) $\frac{1}{2}bt^{1/2}$ (D) $\frac{2}{3}bAt^{3/2}$ (E) $\frac{2}{3}bt^{3/2}$

52. A circular current-carrying loop lies so that the plane of the loop is perpendicular to a constant magnetic field of strength B . Suppose that the radius R of the loop could be made to increase with time t so that $R = at$, where a is a constant. What is the magnitude of the emf that would be generated around the loop as a function of t ?

(A) $2\pi Ba^2t$ (B) $2\pi Bat$ (C) $2\pi Bt$ (D) πBa^2t (E) $(\pi/3)Ba^2t^3$

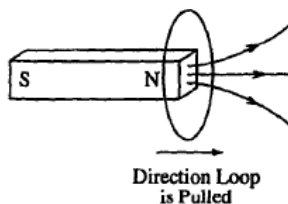

53. A conducting loop of wire that is initially around a magnet is pulled away from the magnet to the right, as indicated in the figure above, inducing a current in the loop. What is the direction of the force on the magnet and the direction of the magnetic field at the center of the loop due to the induced current?

<u>Direction of Force on the Magnet</u>	<u>Direction of Magnetic Field at Center of Loop due to Induced Current</u>
(A) To the right	To the right
(B) To the right	To the left
(C) To the left	To the right
(D) To the left	To the left
(E) No direction; the force is zero.	To the left

54. One of Maxwell's equations can be written as $\oint E \cdot ds = -\frac{d\phi}{dt}$. This equation expresses the fact that

- (A) a changing magnetic field produces an electric field
 (B) a changing electric field produces a magnetic field
 (C) the net magnetic flux through a closed surface depends on the current inside
 (D) the net electric flux through a closed surface depends on the charge inside
 (E) electric charge is conserved

Questions 55-56 relate to the circuit represented below. The switch S, after being open for a long time, is then closed.

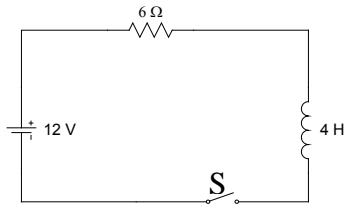

55. What is the current in the circuit after the switch has been closed a long time?
(A) 0 A (B) 1.2 A (C) 2 A (D) 3 A (E) 12 A
56. What is the potential difference across the resistor immediately after the switch is closed?
(A) 0 V (B) 2 V (C) 7.2 V (D) 8 V (E) 12 V

SECTION A – Magnetostatics

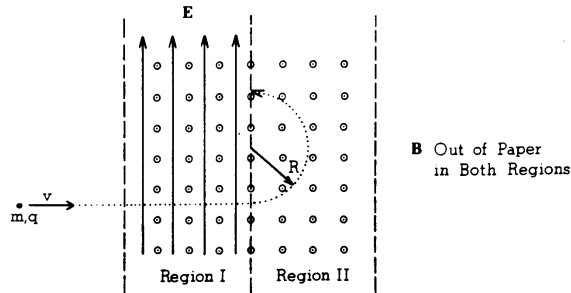

1976E3. An ion of mass m and charge of known magnitude q is observed to move in a straight line through a region of space in which a uniform magnetic field \mathbf{B} points out of the paper and a uniform electric field \mathbf{E} points toward the top edge of the paper, as shown in region I above. The particle travels into region II in which the same magnetic field is present, but the electric field is zero. In region II the ion moves in a circular path of radius R as shown.

- a. Indicate on the diagram below the direction of the force on the ion at point P_2 , in region II.

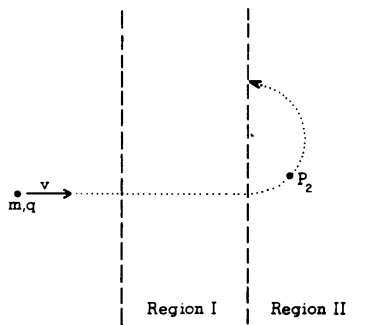

- b. Is the ion positively or negatively charged? Explain clearly the reasoning on which you base your conclusion.
 c. Indicate and label on the diagram below the forces which act on the ion at point P_1 in region I.

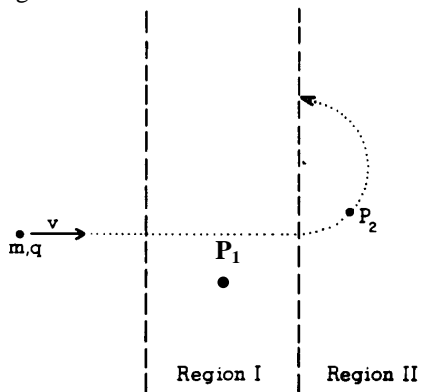

- d. Find an expression for the ion's speed v at point P_1 in terms of E and B .
 e. Starting with Newton's law, derive an expression for the mass m of the ion in terms of B , E , q , and R .

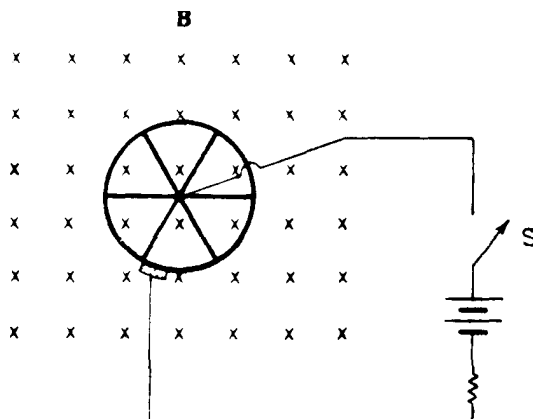

1977E3. A wheel with six spokes is positioned perpendicular to a uniform magnetic field B of magnitude 0.5 tesla (weber per square meter). The field is directed into the plane of the paper and is present over the entire region of the wheel as shown above. When the switch S is closed, there is an initial current of 6 amperes between the axle and the rim, and the wheel begins to rotate. The resistance of the spokes and the rim may be neglected.

- What is the direction of rotation of the wheel? Explain.
- The radius of the wheel is 0.2 meters. Calculate the initial torque on the wheel.

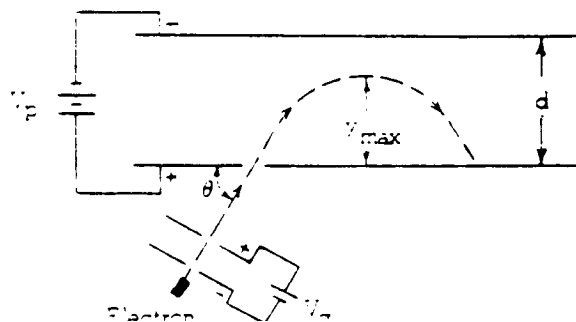

1978E1. Electrons are accelerated from rest in an electron gun between two plates that have a voltage V_g across them. The electrons then move into the region between two other parallel plates of separation d that have voltage V_p across them. The electrons are projected into this region at an angle θ to the plates as shown above. Assume that the entire apparatus is in vacuum and that $V_p > V_g$. Display all results in terms that include d , V_g , V_p , θ , e (the magnitude of the electron charge), and m_o (the electron mass).

- Develop an equation for the speed v_e with which the electrons leave the electron gun.
- Develop an equation for the maximum distance y_{max} that the electrons travel above the lower plate.

Suppose that a magnetic field directed into the plane of the paper is introduced in the region between the upper plates

- How will the speed with which the electrons strike the lower plate be affected? Explain.
- Sketch on the diagram a trajectory that an electron might follow with the magnetic field present. Account qualitatively for the difference between the new and old trajectory.

1979E3. A uniform magnetic field exists in a region of space. Two experiments were done to discover the direction of the field and the following results were obtained.

Experiment I

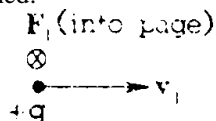

A proton moving to the right with instantaneous velocity \mathbf{v}_1 experienced a force \mathbf{F}_1 directed into the page, as shown above.

Experiment II

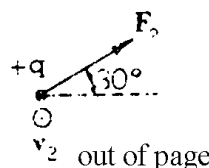

A proton moving out of the page with instantaneous velocity \mathbf{v}_2 experienced a force \mathbf{F}_2 in the plane of the page as shown above.

- State the direction of the magnetic field and show that your choice accounts for the directions of the forces in both experiments.
- In which experiment did the proton describe a circular orbit? Explain your choice and determine the radius of the circular orbit in terms of the given force and velocity for the proton and the proton mass m .
- Describe qualitatively the motion of the proton in the other experiment.

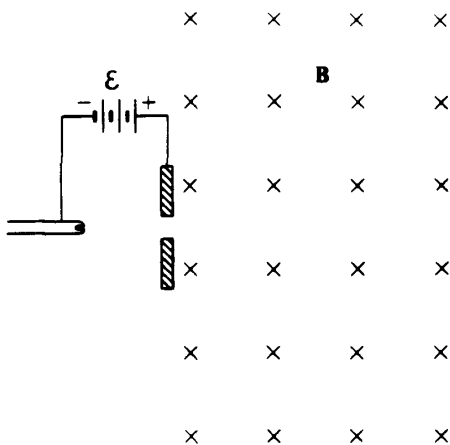

1984E1. An electron from a hot filament in a cathode ray tube is accelerated through a potential difference \mathcal{E} . It then passes into a region of uniform magnetic field \mathbf{B} , directed into the page as shown above. The mass of the electron is m and the charge has magnitude e .

- Find the potential difference \mathcal{E} necessary to give the electron a speed v as it enters the magnetic field.
- On the diagram above, sketch the path of the electron in the magnetic field.
- In terms of mass m , speed v , charge e , and field strength B , develop an expression for r , the radius of the circular path of the electron.
- An electric field \mathbf{E} is now established in the same region as the magnetic field, so that the electron passes through the region undeflected.
 - Determine the magnitude of \mathbf{E} .
 - Indicate the direction of \mathbf{E} on the diagram above.

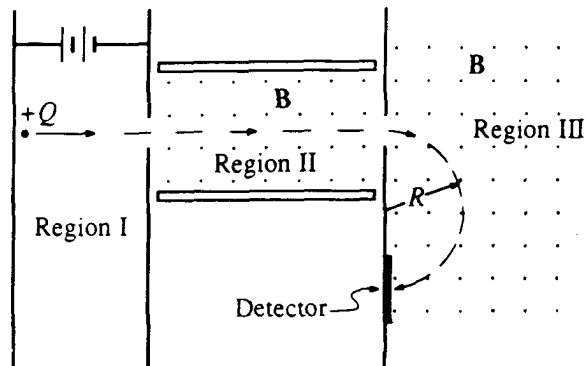

1990E2. In the mass spectrometer shown above, particles having a net charge $+Q$ are accelerated from rest through a potential difference in Region I. They then move in a straight line through Region II, which contains a magnetic field \mathbf{B} and an electric field \mathbf{E} . Finally, the particles enter Region III, which contains only a magnetic field \mathbf{B} , and move in a semicircular path of radius R before striking the detector. The magnetic fields in Regions II and III are uniform, have the same magnitude \mathbf{B} , and are directed out of the page as shown.

- In the figure above, indicate the direction of the electric field necessary for the particles to move in a straight line through Region II.

In terms of any or all the quantities Q , B , E , and R , determine expressions for

- the speed v of the charged particles as they enter Region III;
- the mass m of the charged particles;
- the accelerating potential V in Region I;
- the acceleration a of the particles in Region III;
- the time required for the particles to move along the semicircular path in Region III.

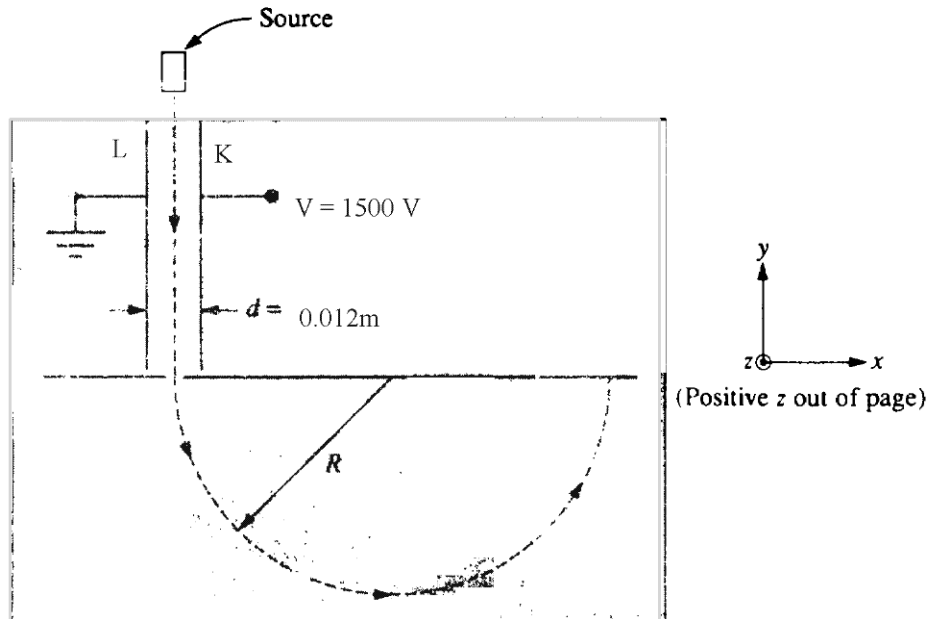

1993E3. A mass spectrometer, constructed as shown in the diagram above, is to be used for determining the mass of singly ionized positively charged ions. There is a uniform magnetic field $B = 0.20$ tesla perpendicular to the page in the shaded region of the diagram. A potential difference $V = 1,500$ volts is applied across the parallel plates L and K, which are separated by a distance $d = 0.012$ meter and which act as a velocity selector.

- In which direction, relative to the coordinate system shown above on the right, should the magnetic field point in order for positive ions to move along the path shown by the dashed line in the diagram above?
- Should plate K have a positive or negative voltage polarity with respect to plate L?
- Calculate the magnitude of the electric field between the plates.
- Calculate the speed of a particle that can pass between the parallel plates without being deflected.
- Calculate the mass of a hypothetical singly charged ion that travels in a semicircle of radius $R = 0.50$ meter.
- A doubly ionized positive ion of the same mass and velocity as the singly charged ion enters the mass spectrometer. What is the radius of its path?

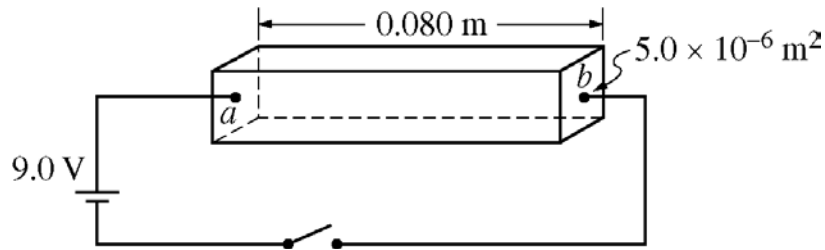

2009E2. A 9.0 V battery is connected to a rectangular bar of length 0.080 m, uniform cross-sectional area $5.0 \times 10^{-6} \text{ m}^2$, and resistivity $4.5 \times 10^{-4} \Omega\text{-m}$, as shown above. Electrons are the sole charge carriers in the bar. The wires have negligible resistance. The switch in the circuit is closed at time $t = 0$.

- Calculate the power delivered to the circuit by the battery.
- On the diagram below, indicate the direction of the electric field in the bar.

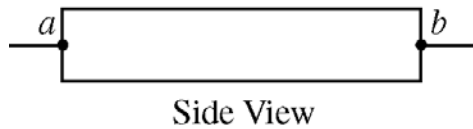

Explain your answer.

- Calculate the strength of the electric field in the bar.

A uniform magnetic field of magnitude 0.25 T perpendicular to the bar is added to the region around the bar, as shown below.

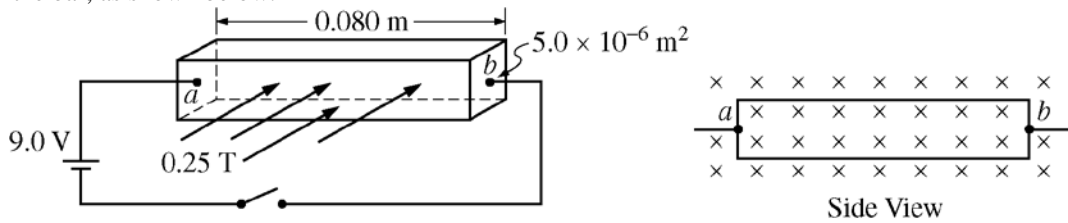

- Calculate the magnetic force on the bar.
- The electrons moving through the bar are initially deflected by the external magnetic field. On the diagram below, indicate the direction of the additional electric field that is created in the bar by the deflected electrons.

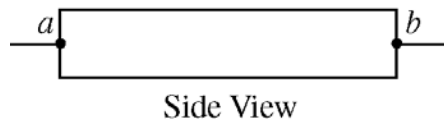

- The electrons eventually experience no deflection and move through the bar at an average speed of $3.5 \times 10^{-3} \text{ m/s}$. Calculate the strength of the additional electric field indicated in part (e).

SECTION B – Biot Savart and Ampere’s Law

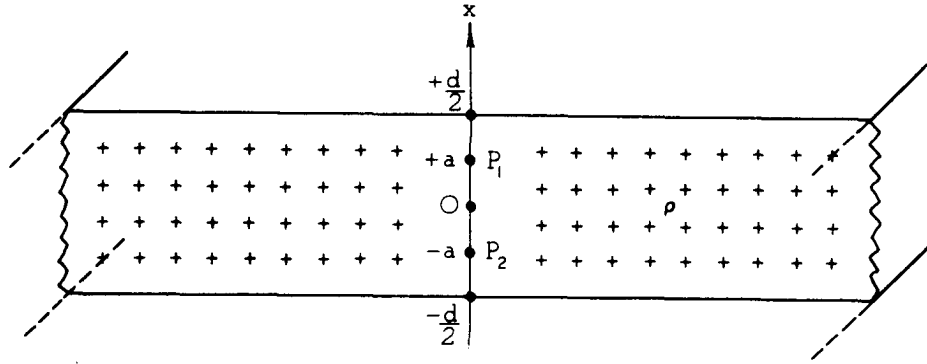

1979E2. A slab of infinite length and infinite width has a thickness d . Point P_1 is a point inside the slab at $x = a$ and point P_2 is a point inside the slab at $x = -a$. For parts (a) and (b) consider the slab to be nonconducting with uniform charge per unit volume ρ as shown.

- a. Sketch vectors representing the electric field \mathbf{E} at points P_1 and P_2 on the following diagram.

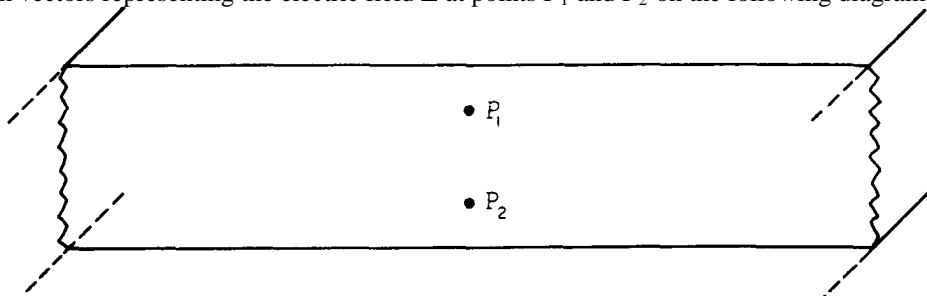

- b. Use Gauss's law and symmetry arguments to determine the magnitude of \mathbf{E} at point P_1 .

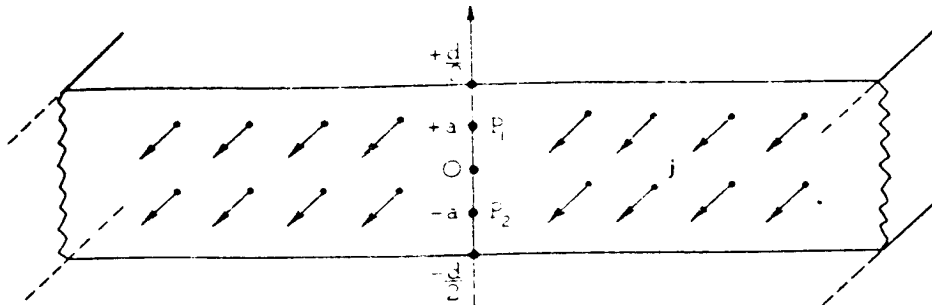

For parts (c) and (d), consider the slab to be conducting and uncharged but with a uniform current density \mathbf{j} directed out of the page as shown below.

- c. Sketch vectors representing the magnetic field \mathbf{B} at points P_1 and P_2 on the following diagram.

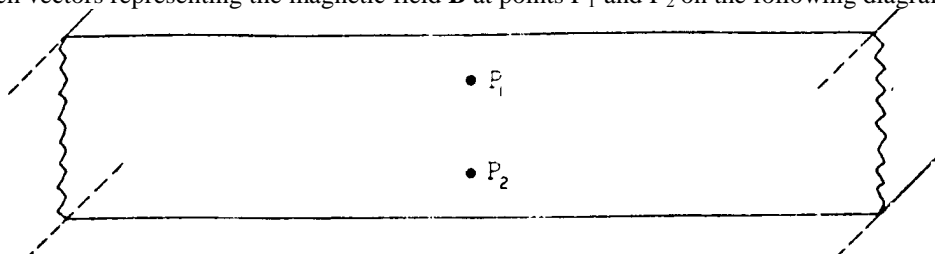

- d. Use Ampere’s law and symmetry arguments to determine the magnitude of \mathbf{B} at point P_1 .

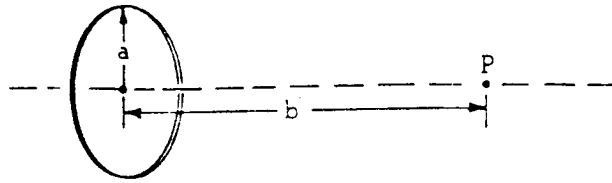

Figure I

- 1981E2. A ring of radius a has a total charge $+Q$ distributed uniformly around its circumference. As shown in Figure I, the point P is on the axis of the ring at a distance b from the center of the ring.
- On Figure I above, show the direction of the electric field at point P .
 - Determine the magnitude of the electric field intensity at point P .

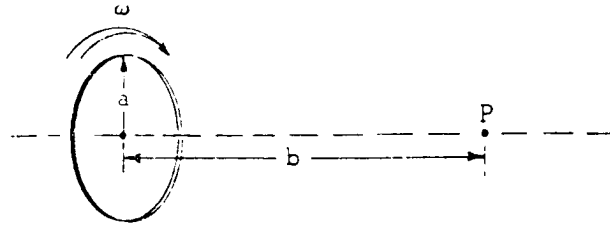
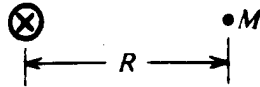

Figure II

As shown in Figure II, the ring is now rotated about its axis at a uniform angular velocity ω in a clockwise direction as viewed from point P . The charge moves with the ring.

- Determine the current of this moving charge.
- on Figure II above, draw the direction of the magnetic field at point P .
- Determine the magnitude B of the magnetic field at point P .



1983E3.

- A long straight wire carries current I into the plane of the page as shown above. Using Ampere's law, develop an expression for the magnetic field intensity at a point M that is a distance R from the center of the wire. On the diagram above indicate your path of integration and indicate the direction of the field at point M .

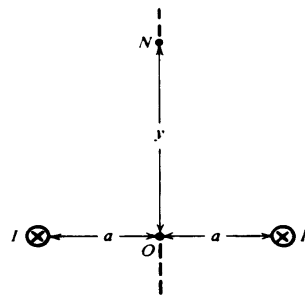

- Two long parallel wires that are a distance $2a$ apart carry equal currents I into the plane of the page as shown above.
 - Determine the resultant magnetic field intensity at the point O midway between the wires.
 - Develop an expression for the resultant magnetic field intensity at the point N , which is a vertical distance of y above point O . On the diagram above indicate the direction of the resultant magnetic field at point N .

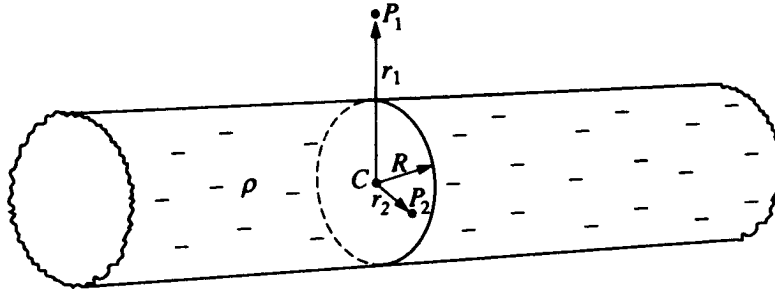

1993E1. The solid nonconducting cylinder of radius R shown above is very long. It contains a negative charge evenly distributed throughout the cylinder, with volume charge density ρ . Point P_1 is outside the cylinder at a distance r_1 from its center C and point P_2 is inside the cylinder at a distance r_2 from its center C . Both points are in the same plane, which is perpendicular to the axis of the cylinder.

- a. On the following cross-sectional diagram, draw vectors to indicate the directions of the electric field at points P_1 and P_2 .

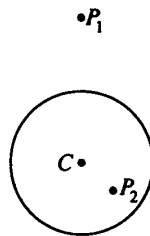

- b. Using Gauss's law, derive expressions for the magnitude of the electric field E in terms of r , R , ρ , and fundamental constants for the following two cases.
- $r > R$ (outside the cylinder)
 - $r < R$ (inside the cylinder)

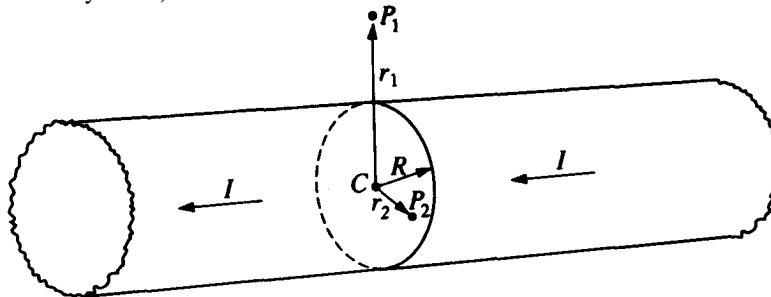

Another cylinder of the same dimensions, but made of conducting material, carries a total current I parallel to the length of the cylinder, as shown in the diagram above. The current density is uniform throughout the cross-sectional area of the cylinder. Points P_1 and P_2 are in the same positions with respect to the cylinder as they were for the nonconducting cylinder.

- c. On the following cross-sectional diagram in which the current is out of the plane of the page (toward the reader), draw vectors to indicate the directions of the magnetic field at points P_1 and P_2 .



- d. Use Ampere's law to derive an expression for the magnetic field B inside the cylinder in terms of r , R , I , and fundamental constants.

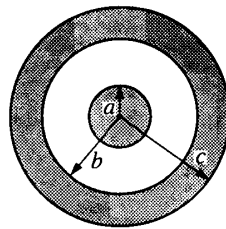

Cross Section

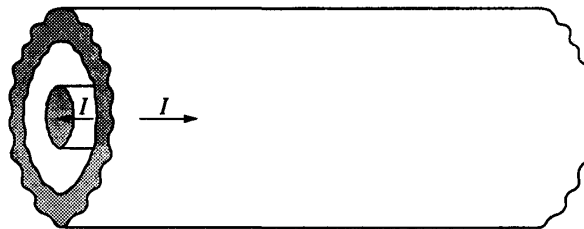

Coaxial Cable

1994E3. A long coaxial cable, a section of which is shown above, consists of a solid cylindrical conductor of radius a , surrounded by a hollow coaxial conductor of inner radius b and outer radius c . The two conductors each carry a uniformly distributed current I , but in opposite directions. The current is to the right in the outer cylinder and to the left in the inner cylinder. Assume $\mu = \mu_0$ for all materials in this problem.

- Use Ampere's law to determine the magnitude of the magnetic field at a distance r from the axis of the cable in each of the following cases.
 - $0 < r < a$
 - $a < r < b$
- What is the magnitude of the magnetic field at a distance $r = 2c$ from the axis of the cable?
- On the axes below, sketch the graph of the magnitude of the magnetic field B as a function of r , for all values of r . You should estimate and draw a reasonable graph for the field between b and c rather than attempting to determine an exact expression for the field in this region.

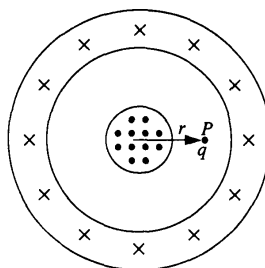
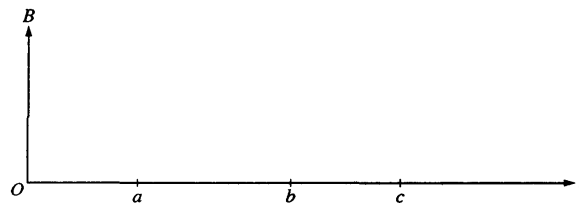

Cross Section

The coaxial cable continues to carry currents I as previously described. In the cross section above, current is directed out of the page toward the reader in the inner cylinder and into the page in the outer cylinder. Point P is located between the inner and outer cylinders, a distance r from the center. A small positive charge q is introduced into the space between the conductors so that when it is at point P its velocity v is directed out of the page, perpendicular to it, and parallel to the axis of the cable.

- Determine the magnitude of the force on the charge q at point P in terms of the given quantities.
 - Draw an arrow on the diagram at P to indicate the direction of the force.
- If the current in the outer cylinder were reversed so that it is directed out of the page, how would your answers to (d) change, if at all?

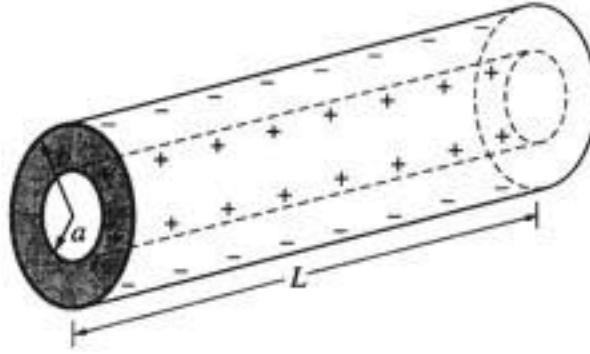

2000E3. A capacitor consists of two conducting, coaxial, cylindrical shells of radius a and b , respectively, and length $L \gg b$. The space between the cylinders is filled with oil that has a dielectric constant κ . Initially both cylinders are uncharged, but then a battery is used to charge the capacitor, leaving a charge $+Q$ on the inner cylinder and $-Q$ on the outer cylinder, as shown above. Let r be the radial distance from the axis of the capacitor.

- a. Using Gauss's law, determine the electric field midway along the length of the cylinder for the following values of r , in terms of the given quantities and fundamental constants. Assume end effects are negligible.
 - i. $a < r < b$
 - ii. $b < r \ll L$
- b. Determine the following in terms of the given quantities and fundamental constants.
 - i. The potential difference across the capacitor
 - ii. The capacitance of this capacitor

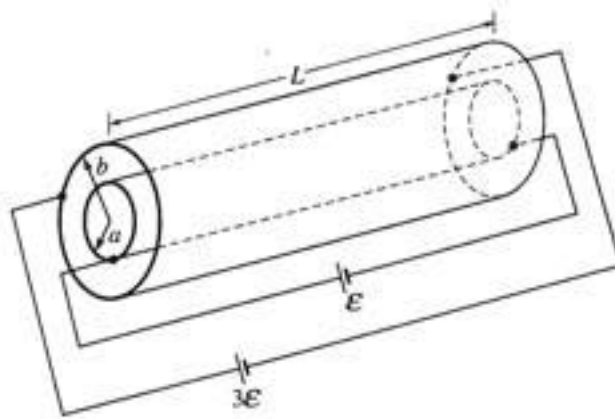

- c. Now the capacitor is discharged and the oil is drained from it. As shown above, a battery of emf ϵ is connected to opposite ends of the inner cylinder and a battery of emf 3ϵ is connected to opposite ends of the outer cylinder. Each cylinder has resistance R . Assume that end effects and the contributions to the magnetic field from the wires are negligible. Using Ampere's law, determine the magnitude B of the magnetic field midway along the length of the cylinders due to the current in the cylinders for the following values of r .
 - i. $a < r < b$
 - ii. $b < r \ll L$

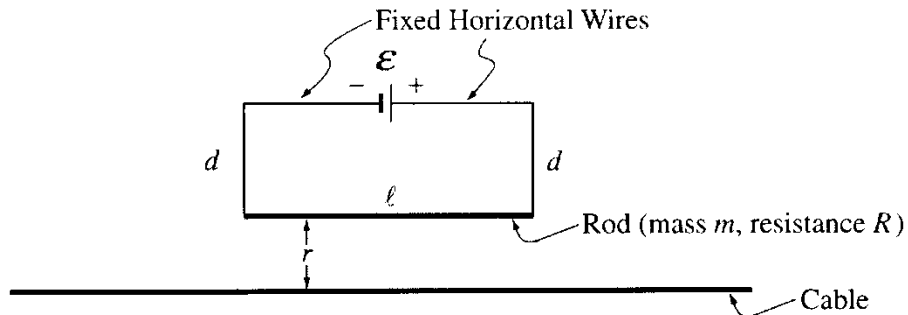

2001E3. The circuit shown above consists of a battery of emf \mathcal{E} in series with a rod of length l , mass m , and resistance R . The rod is suspended by vertical connecting wires of length d , and the horizontal wires that connect to the battery are fixed. All these wires have negligible mass and resistance. The rod is a distance r above a conducting cable. The cable is very long and is located directly below and parallel to the rod. Earth's gravitational pull is toward the bottom of the page. Express all algebraic answers in terms of the given quantities and fundamental constants.

- What is the magnitude and direction of the current I in the rod?
- In which direction must there be a current in the cable to exert an upward force on the rod? Justify your answer.
- With the proper current in the cable, the rod can be lifted up such that there is no tension in the connecting wires. Determine the minimum current I_C in the cable that satisfies this situation.
- Determine the magnitude of the magnetic flux through the circuit due to the minimum current I_C determined in part c.

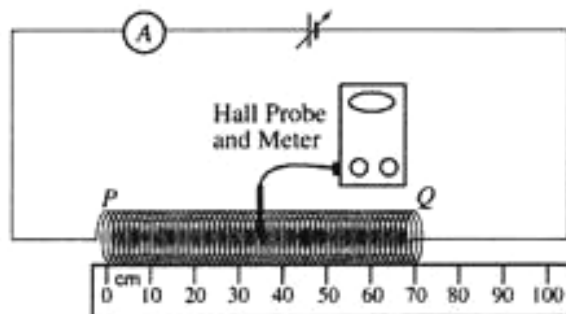

2005E3. A student performs an experiment to measure the magnetic field along the axis of the long, 100-turn solenoid PQ shown above. She connects ends P and Q of the solenoid to a variable power supply and an ammeter as shown. End P of the solenoid is taped at the 0 cm mark of a meter stick. The solenoid can be stretched so that the position of end Q can be varied. The student then positions a Hall probe* in the center of the solenoid to measure the magnetic field along its axis. She measures the field for a fixed current of 3.0 A and various positions of the end Q . The data she obtains are shown below.

* A Hall Probe is a device used to measure the magnetic field at a point.

Trial	Position of End Q (cm)	Measured Magnetic Field (T) (directed from P to Q)	n (turns/m)
1	40	9.70×10^{-4}	
2	50	7.70×10^{-4}	
3	60	6.80×10^{-4}	
4	80	4.90×10^{-4}	
5	100	4.00×10^{-4}	

- Complete the last column of the table above by calculating the number of turns per meter.
- On the axes below, plot the measured magnetic field B versus n . Draw a best-fit straight line for the data points.

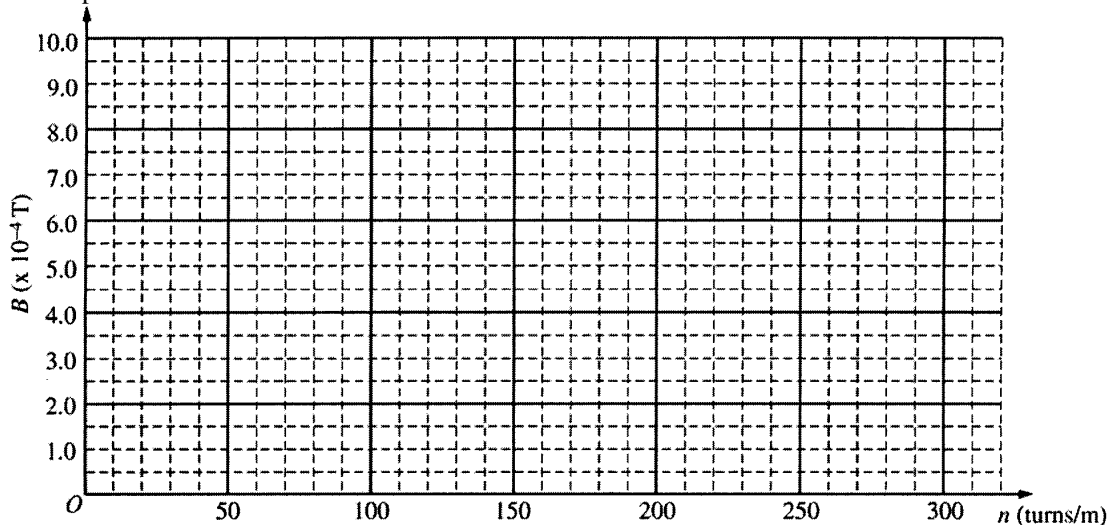

- From the graph, obtain the value of μ_0 , the magnetic permeability of vacuum.
- Using the theoretical value of $\mu_0 = 4\pi \times 10^{-7}$ T m/A, determine the percent error in the experimental value of μ_0 computed in part (c).

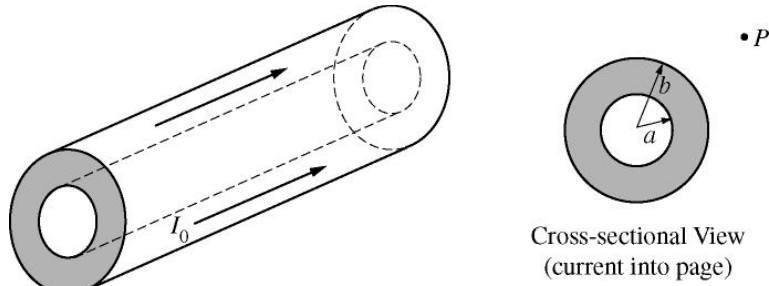

2011E3. A section of a long conducting cylinder with inner radius a and outer radius b carries a current I_0 that has a uniform current density, as shown in the figure above.

- (a) Using Ampère's law, derive an expression for the magnitude of the magnetic field in the following regions as a function of the distance r from the central axis.
- i. $r < a$
 - ii. $a < r < b$
 - iii. $r = 2b$
- (b) On the cross-sectional view in the diagram above, indicate the direction of the field at point P , which is at a distance $r = 2b$ from the axis of the cylinder.
- (c) An electron is at rest at point P . Describe any electromagnetic forces acting on the electron. Justify your answer.

Now consider a long, solid conducting cylinder of radius b carrying a current I_0 . The magnitude of the magnetic field inside this cylinder as a function of r is given by $B = \mu_0 I_0 r / 2\pi b^2$. An experiment is conducted using a particular solid cylinder of radius 0.010 m carrying a current of 25 A. The magnetic field inside the cylinder is measured as a function of r , and the data is tabulated below.

Distance r (m)	0.002	0.004	0.006	0.008	0.010
Magnetic Field B (T)	1.2×10^{-4}	2.7×10^{-4}	3.6×10^{-4}	4.7×10^{-4}	6.4×10^{-4}

- (d) i. On the graph below, plot the data points for the magnetic field B as a function of the distance r , and label the scale on both axes. Draw a straight line that best represents the data.

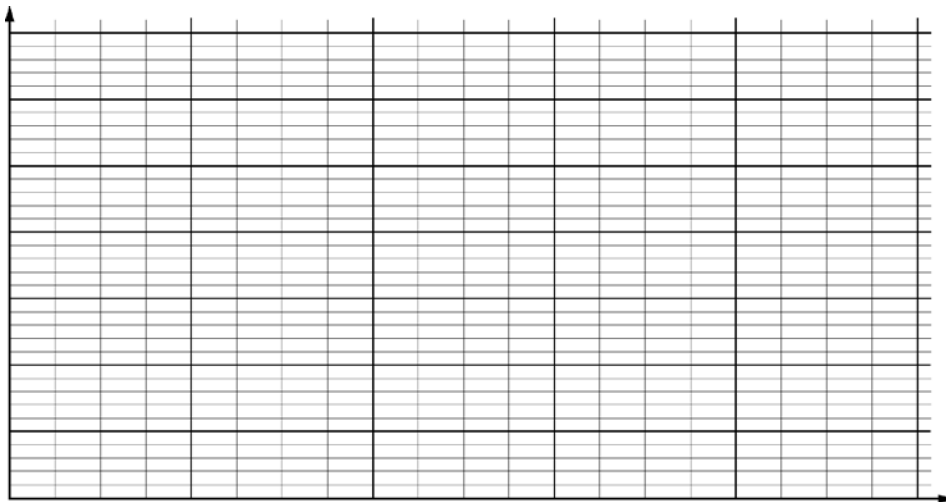

- ii. Use the slope of your line to estimate a value of the permeability μ_0 .

SECTION C – Induction and Inductance

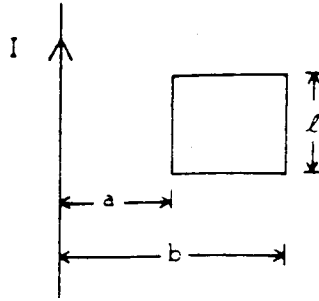

- 1975E3. A long straight conductor lies in the plane of a rectangular loop of wire as shown above. The total resistance of the loop is R . The current in the long straight conductor increases at a constant rate dI/dt .
- Indicate on the diagram the direction of the induced current in the loop and explain your reasoning.
 - Determine the magnitude of the current assuming the self-inductance of the loop may be neglected.
-

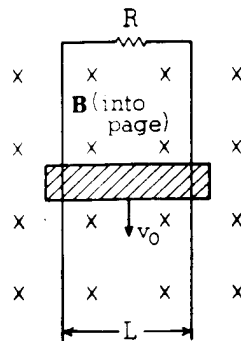

- 1976E2. A conducting bar of mass M slides without friction down two vertical conducting rails which are separated by a distance L and are joined at the top through an unknown resistance R . The bar maintains electrical contact with the rails at all times. There is a uniform magnetic field B , directed into the page as shown above. The bar is observed to fall with a constant terminal speed v_0 .
- On the diagram below, draw and label all the forces acting on the bar.



- Determine the magnitude of the induced current I in the bar as it falls with constant speed v_0 in terms of B , L , g , v_0 , and M .
- Determine the voltage induced in the bar in terms of B , L , g , v_0 , and M .
- Determine the resistance R in terms of B , L , g , v_0 , and M .

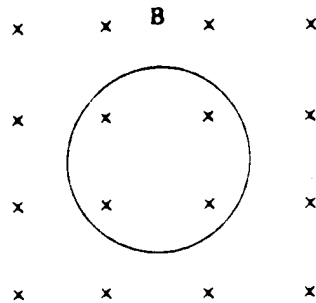

- 1978E2. A circular loop of wire of area A and electrical resistance R is placed in a spatially uniform magnetic field B directed into the page and perpendicular to the plane of the loop as shown above. The magnetic field is gradually reduced from an initial value of B_0 , in such a way that the magnetic field strength as a function of time is $B(t) = B_0 e^{-\alpha t}$.
- Indicate on the diagram the direction of the induced current. Applying the fundamental relation for electromagnetic induction, explain your choice.
 - Do the electromagnetic forces on this current tend to make the loop expand or contract? Explain.
 - Determine an expression, in terms of B_0 , A , and R , that describes the total quantity of charge that flows past a point in the loop during the time the magnetic field is reduced from B_0 to zero.
 - Determine an expression for the amount of energy dissipated as heat in the loop, in terms of B_0 , A , R , and α , during the time the magnetic field is reduced from B_0 to zero.

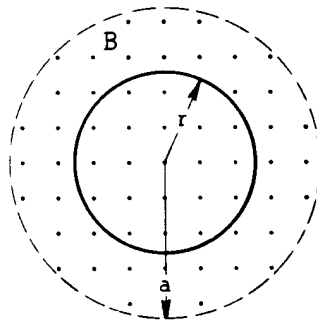

- 1980E3. A spatially uniform magnetic field directed out of the page is confined to a cylindrical region of space of radius a as shown above. The strength of the magnetic field increases at a constant rate such that $B = B_0 + Ct$, where B_0 and C are constants and t is time. A circular conducting loop of radius r and resistance R is placed perpendicular to the magnetic field.
- Indicate on the diagram above the direction of the induced current in the loop. Explain your choice.
 - Derive an expression for the induced current in the loop.
 - Derive an expression for the magnitude of the induced electric field at any radius $r < a$.
 - Derive an expression for the magnitude of the induced electric field at any radius $r > a$.

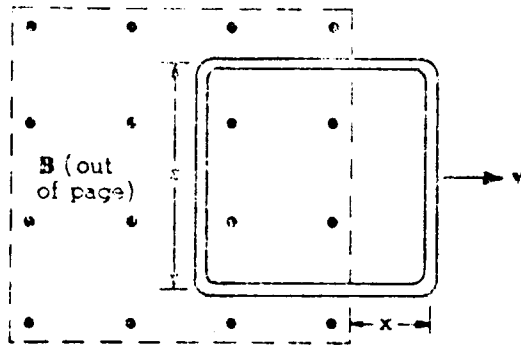

1981E3. A square loop of wire of side s and resistance R is pulled at constant velocity \mathbf{v} out of a uniform magnetic field of intensity B . The plane of the loop is always perpendicular to the magnetic field. After the leading edge of the loop has passed the edge of the B field as shown in the figure above, there is an induced current in the loop.

- On the figure above, indicate the direction of this induced current.
- Using Faraday's law of induction, develop an expression for the induced emf \mathcal{E} in the loop.
- Determine the induced current I in the loop.
- Determine the power required to keep the loop moving at constant velocity.

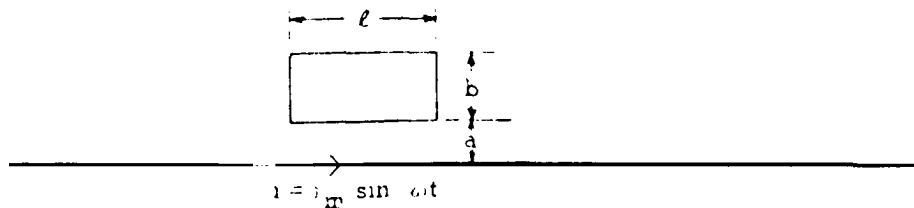

1982E2. As shown above a rectangular loop is located next to a long straight wire carrying a current $i = i_m \sin \omega t$

The wire and the loop are in the plane of the page and fixed in space

- Using Ampere's law, show that the magnetic field intensity at a distance r from the wire is $B = \mu_0 i / 2\pi r$, with μ_0 being the permeability of free space.
- Find the magnetic flux Φ_B through the loop at time t .
- The current i in the long wire is in the direction shown above from $t = 0$ to $t = \pi/\omega$.
 - indicate on the diagram above the direction of the resulting current induced in the loop at time $t = \pi/\omega$
 - Determine the emf that is induced in the loop at time $t = \pi/\omega$.

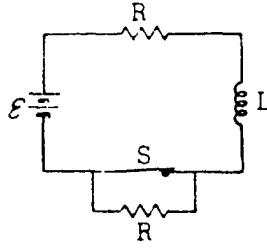

- 1982E3. When the switch S in the circuit shown above is closed, an inductance L is in series with a resistance R and battery of emf \mathcal{E} .
- Determine the current i in the circuit after the switch S has been closed for a very long time. After being closed for a very long time, the switch S is opened at time $t = 0$.
 - Determine the current i_B in the circuit after the switch has been open for a very long time.
 - On the axes below, sketch a graph of the current as a function of time t for $t \geq 0$ and indicate the values of the currents i_A and i_B on the vertical axis



- By relating potential difference and emfs around the circuit, write the differential equation that can be used to determine the current as a function of time.
- Write the equation for the current as a function of time for all time $t \geq 0$.

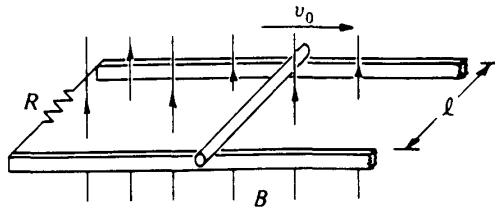

- 1984E3. Two horizontal conducting rails are separated by a distance l as shown above. The rails are connected at one end by a resistor of resistance R . A conducting rod of mass m can slide without friction along the rails. The rails and the rod have negligible resistance. A uniform magnetic field of magnitude B is perpendicular to the plane of the rails as shown. The rod is given a push to the right and then allowed to coast. At time $t = 0$ (immediately after it is pushed) the rod has a speed v_0 to the right.
- Indicate on the diagram above the direction of the induced current in the resistor.
 - In terms of the quantities given, determine the magnitude of the induced current in the resistor at time $t = 0$.
 - Indicate on the diagram above the direction of the force on the rod.
 - In terms of the quantities given, determine the magnitude of the force acting on the rod at time $t = 0$.

If the rod is allowed to continue to coast, its speed as a function of time will be as follows.

$$v = v_0 e^{-(B^2 l^2 t / Rm)}$$

- In terms of the quantities given, determine the power developed in the resistor as a function of time t .
- Show that the total energy produced in the resistor is equal to the initial kinetic energy of the bar.

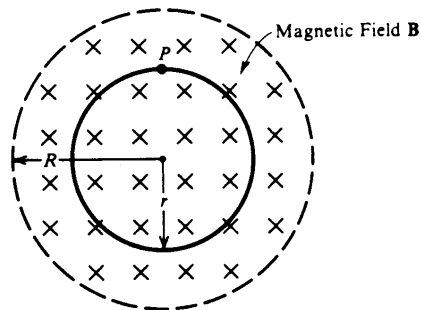

- 1985E3. A spatially uniform magnetic field B , perpendicular to the plane of the page, exists in a circular region of radius $R = 0.75$ meter as shown above. A single wire loop of radius $r = 0.5$ meter is placed concentrically in the magnetic field and in the plane of the page. The magnetic field increases into the page at a constant rate of 60 teslas per second.
- Determine the induced emf in the loop.
 - Determine the magnitude and direction of the induced electric field at point P and indicate its direction on the diagram above.
The wire loop is replaced by an evacuated doughnut-shaped glass tube, within which a single electron orbits at a constant radius $r = 0.5$ meter when the spatially uniform magnetic field is constant at 10^{-4} tesla.
 - Determine the speed of the electron in this orbit.
 - The magnetic field is now made to increase at a constant rate of 60 teslas per second as in parts (a) and (b) above. Determine the tangential acceleration of the electron at the instant the field begins to increase.

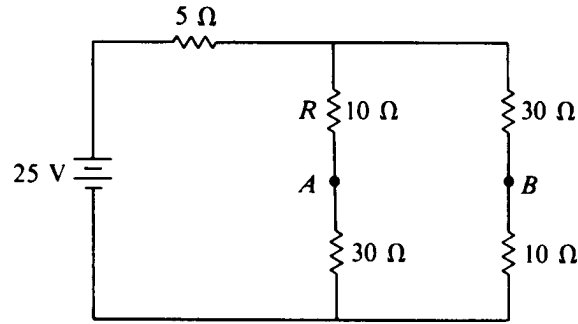

1986E2. Five resistors are connected as shown above to a 25-volt source of emf with zero internal resistance.

- a. Determine the current in the resistor labeled R .

A 10-microfarad capacitor is connected between points A and B . The currents in the circuit and the charge on the capacitor soon reach constant values. Determine the constant value for each of the following.

- b. The current in the resistor R
 c. The charge on the capacitor

The capacitor is now replaced by a 2.0-henry inductor with zero resistance. The currents in the circuit again reach constant values. Determine the constant value for each of the following.

- d. The current in the resistor R
 e. The current in the inductor

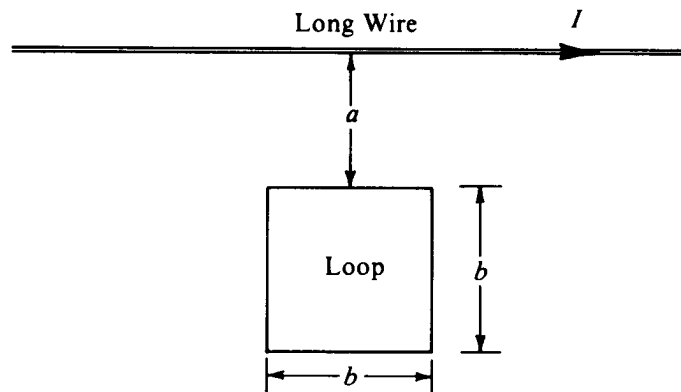

1986E3. A long wire carries a current in the direction shown above. The current I varies linearly with time t as follows: $I = ct$, where c is a positive constant. The long wire is in the same plane as a square loop of wire of side b , as shown in the diagram. The side of the loop nearest the long wire is parallel to it and a distance a from it. The loop has a resistance R and is fixed in space.

- a. Determine the magnetic field B at a distance r from the long wire as a function of time.
 b. Indicate on the diagram the direction of the induced current in the loop.
 c. Determine the induced current in the loop.
 d. State whether the magnetic force on the loop is toward or away from the wire.
 e. Determine the magnitude of the magnetic force on the loop as a function of time.

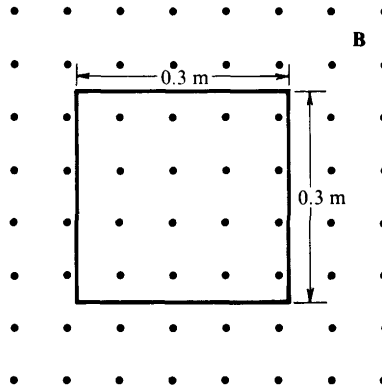

1987E2. A square wire loop of resistance 6 ohms and side of length 0.3 meter lies in the plane of the page, as shown above. The loop is in a magnetic field B that is directed out of the page. At time $t = 0$, the field has a strength of 2 teslas; it then decreases according to the equation $B = 2e^{-4t}$, where B is in teslas and t is in seconds.

- Determine an expression for the flux through the loop as a function of time t for $t > 0$.
- On the diagram above, indicate the direction of the current induced in the loop for time $t > 0$.
- Determine an expression for the current induced in the loop for time $t > 0$.
- Determine the total energy dissipated as heat during the time from zero to infinity.

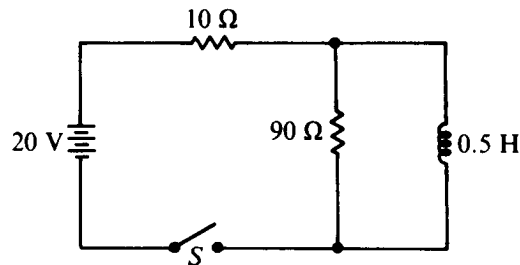

1987E3. In the circuit shown above, the switch S is initially open and all currents are zero. For the instant immediately after the switch is closed, determine each of the following.

- The potential difference across the 90-ohm resistor
 - The rate of change of current in the inductor
- The switch has remained closed for a long time. Determine each of the following.
- The current in the inductor
 - The energy stored in the inductor
- Later, at time t_0 , the switch is reopened.
- For the instant immediately after the switch is reopened, determine the potential difference across the 90-ohm resistor.
 - On the axes below, sketch a graph of the potential difference across the 90-ohm resistor for $t > t_0$.

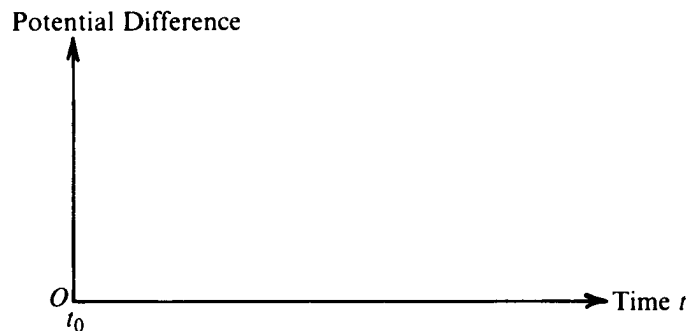

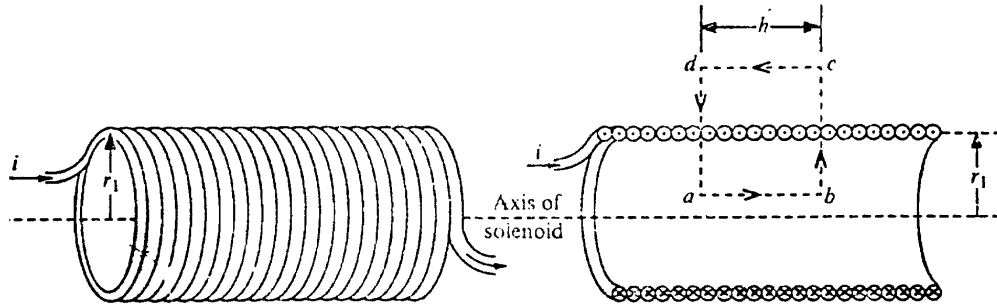

- 1988E3. The long solenoid shown in the left-hand figure above has radius r_1 and n turns of wire per unit length, and it carries a current i . The magnetic field outside the solenoid is negligible.
- Apply Ampere's law using the path $abcd$ indicated in the cross section shown in the righthand figure above to derive an expression for the magnitude of the magnetic field B near the center of the solenoid

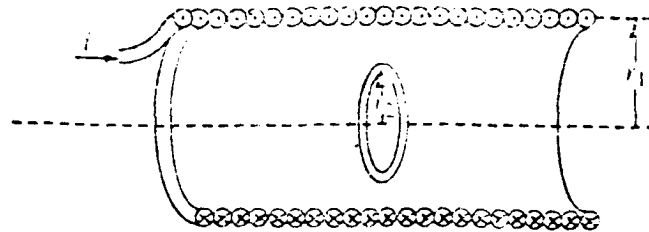

A loop of radius r_2 is then placed at the center of the solenoid, so that the plane of the loop is perpendicular to the axis of the solenoid, as shown above. The current in the solenoid is decreased at a steady rate from i to zero in time t . In terms of the given quantities and fundamental constants, determine:

- The emf induced in the loop.
- The magnitude of the induced electric field at a point in the loop.

The loop is now removed and another loop of radius r_3 is placed outside the solenoid, so that the plane of the loop is perpendicular to the axis of the solenoid, as shown above. The current in the solenoid is again decreased at a steady rate from i to zero in time t . In terms of the given quantities and fundamental constants, determine:

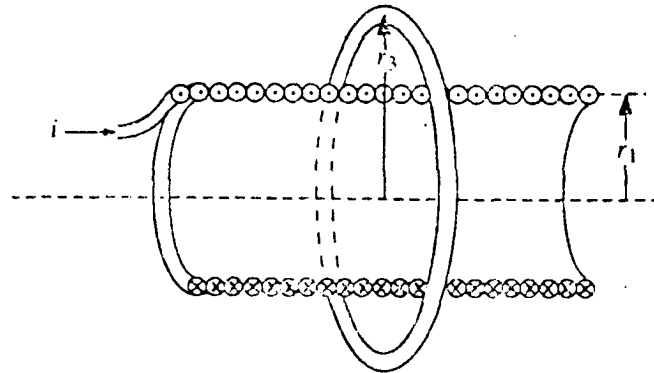

- The emf induced in the loop.
- The magnitude of the induced electric field at a point in the loop.

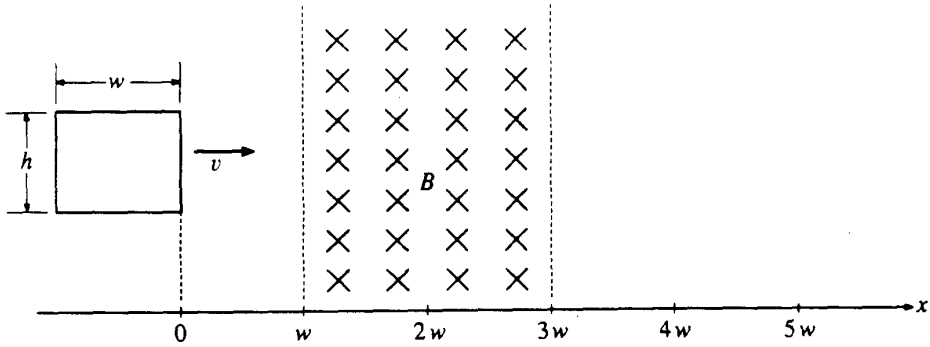

1989E2. A rectangular loop of wire of resistance R and dimensions h and w moves with a constant speed v toward and through a region containing a uniform magnetic field of strength B directed into the plane of the page. The region has a width of w as shown above.

- For the interval after the right-hand edge of the loop has entered the field but before the left-hand side of the loop has reached the field, determine each of the following in terms of B , w , h , v , and R .
 - The magnitude of the induced current in the loop
 - The magnitude of the applied force required to move the loop at constant speed
- On the axes below, plot the following as functions of position x of the right edge of the loop shown above.
 - The induced current I in the loop
 - The applied force F required to keep the loop moving at constant speed

Let counterclockwise current be positive, clockwise current be negative, forces to the right be positive, and forces to the left be negative. The graphs should begin with the loop in the position shown ($x = 0$) and continue until the right edge of the loop is a distance $2w$ to the right of the region containing the field ($x = 5w$).

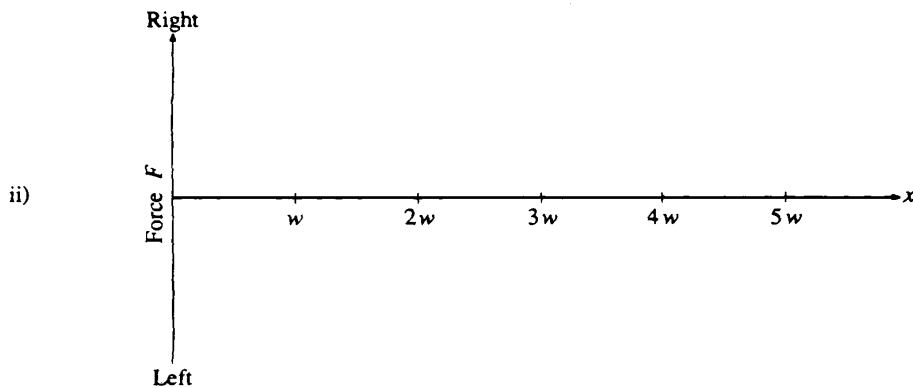
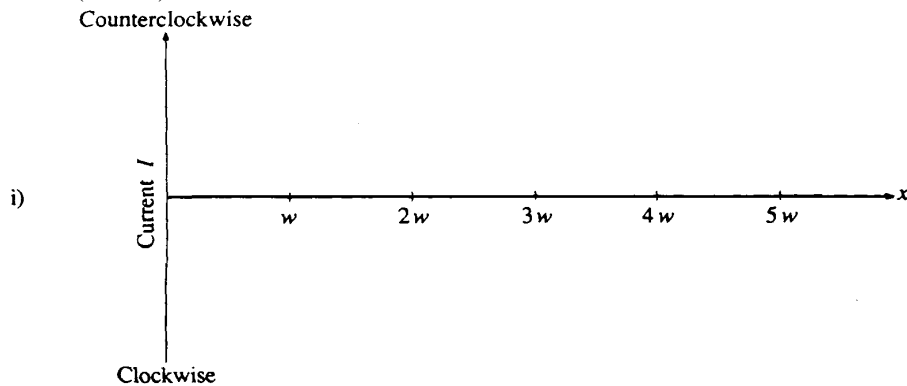

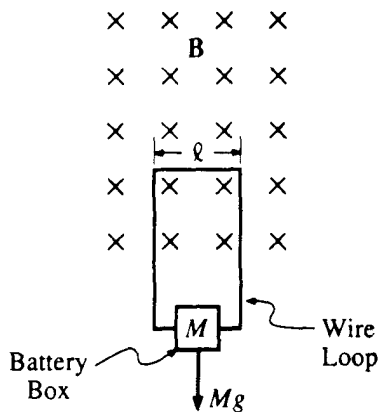

1990E3. A uniform magnetic field of magnitude B is horizontal and directed into the page in a rectangular region of space, as shown above. A light, rigid wire loop, with one side of width l , has current I . The loop is supported by the magnetic field, and hangs vertically, as shown. The wire has resistance R and supports a box that holds a battery to which the wire loop is connected. The total mass of the box and its contents is M .

- a. On the following diagram that represents the rigid wire loop, indicate the direction of the current I .

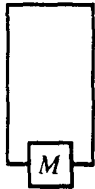

The loop remains at rest. In terms of any or all of the quantities B , l , M , R , and appropriate constants, determine expressions for

- b. the current I in the loop;
 c. the emf of the battery, assuming it has negligible internal resistance.

An amount of mass Δm is removed from the box and the loop then moves upward, reaching a terminal speed v in a very short time, before the box reaches the field region. In terms of v and any or all of the original variables, determine expressions for

- d. the magnitude of the induced emf;
 e. the current I' in the loop under these new conditions;
 f. the amount of mass Δm removed.

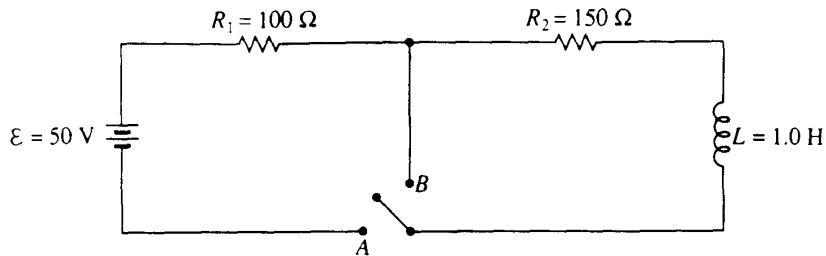

1991E2. In the circuit above, the switch is initially open as shown. At time $t = 0$, the switch is closed to position A.

- Determine the current immediately after the switch is closed.
- Determine the current after a long time when a steady state situation has been reached.
- On the axes below, sketch a graph of the current *versus* time after the switch is closed.



- Determine the energy stored in the inductor L when the steady state has been reached.

Some time after the steady state situation has been reached, the switch is moved almost instantaneously from position A to position B.

- Determine the current in the inductor immediately after the position of the switch is changed.
- Determine the potential difference across the inductor immediately after the position of the switch is changed.
- What happens to the energy stored in the inductor as calculated in part (d) above?

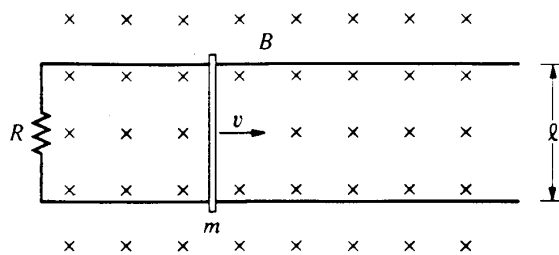

View from Above

1991E3. A conducting rod is free to move on a pair of horizontal, frictionless conducting rails a distance l apart. The rails are connected at one end so a complete circuit is formed. The rod has a mass m , the resistance of the circuit is R , and there is a uniform magnetic field of magnitude B directed perpendicularly into the plane of the rails, as shown above. The rod and the rails have negligible resistance. At time $t = 0$, the rod has a speed v_0 to the right. Determine each of the following in terms of l , m , R , B , and v_0 .

- The induced voltage in the rod at $t = 0$
- The magnitude and the direction of the magnetic force on the rod at $t = 0$
- The speed v of the rod as a function of time t
- The total energy dissipated by the resistor beginning at $t = 0$

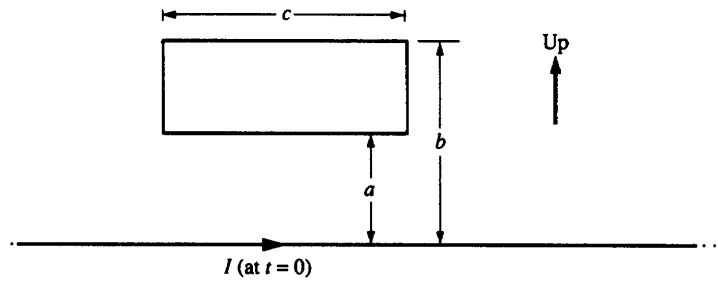

1992E3. The rectangular wire loop shown above has length c , width $(b - a)$, and resistance R . It is placed in the plane of the page near a long straight wire, also in the plane of the page. The long wire carries a time-dependent current $I = \alpha(1 - \beta t)$, where α and β are positive constants and t is time.

- What is the direction of the magnetic field inside the loop due to the current I in the long wire at $t=0$?
- In terms of a , b , c , α , β and fundamental constants, determine the following.
 - An expression for the magnitude of the magnetic flux through the loop as a function of t .
 - The magnitude of the induced emf in the loop.
- Show on the diagrams below the directions of the induced current in the loop for each of the following cases.

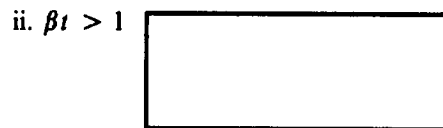

- What is the direction of the net force, if any, on the loop due to the induced current at $t = 0$?

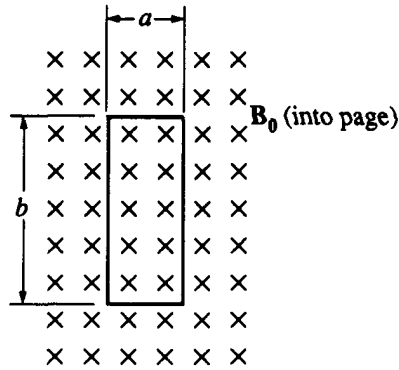

- 1993E2. A rectangular loop of copper wire of resistance R has width a and length b . The loop is stationary in a constant, uniform magnetic field B_0 , directed into the page as shown above.
- What is the net magnetic flux through the loop of wire?
 - What is the induced emf in the loop of wire?
 - What is the net magnetic force on the loop of wire?

Suppose instead that the uniform magnetic field varies with time t according to the relationship $B = B_0 \cos(\omega t)$, where ω , and B_0 are positive constants and B is positive when the field is directed into the page.

- Indicate on the diagram below the direction of the induced current in the loop when $\omega t = \pi/2$, after the magnetic field begins to oscillate.



- Derive the expression for the magnitude of the induced current in the loop as a function of time in terms of a , b , B_0 , R , t , and fundamental constants.
 - On the axes below, sketch a graph of the induced current I versus ωt , taking clockwise current to be positive.

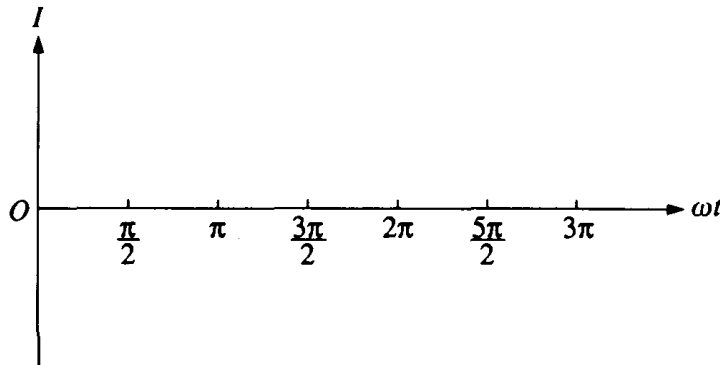

- State explicitly the maximum value of the current I .

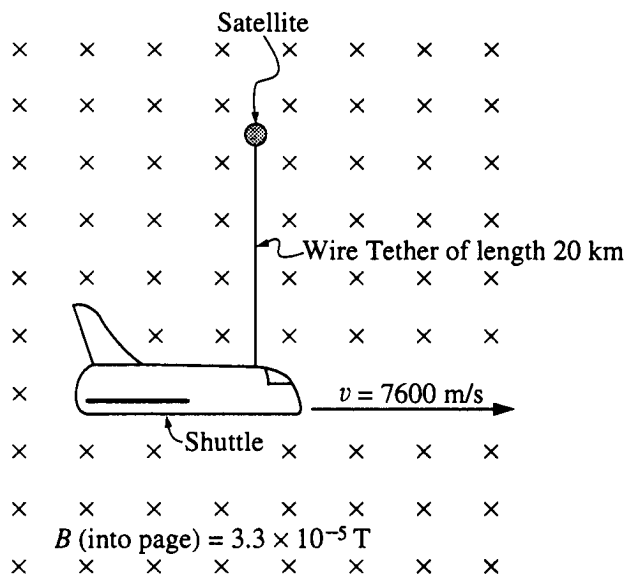

Note: Figure not drawn to scale.

- 1994E2. One of the space shuttle missions attempted to perform an experiment in orbit using a tethered satellite. The satellite was to be released and allowed to rise to a height of 20 kilometers above the shuttle. The tether was a 20-kilometer copper-core wire, thin and light, but extremely strong. The shuttle was in an orbit with speed 7,600 meters per second, which carried it through a region where the magnetic field of the Earth had a magnitude of 3.3×10^{-5} tesla. For your calculations, assume that the experiment was completed successfully, that the wire is perpendicular to the magnetic field, and that the field is uniform.
- An emf is generated in the tether.
 - Which end of the tether is negative?
 - Calculate the magnitude of the emf generated.

To complete the circuit, electrons are sprayed from the object at the negative end of the tether into the ionosphere and other electrons come from the ionosphere to the object at the positive end.

- If the resistance of the entire circuit is about 10,000 ohms, calculate the current that flows in the tether.
- A magnetic force acts on the wire as soon as the current begins to flow.
 - Calculate the magnitude of the force.
 - State the direction of the force.
- By how much would the shuttle's orbital energy change if the current remains constant at the value calculated in (b) for a period of 7 days in orbit?
- Imagine that the astronauts forced a current to flow the other way. What effect would that have, if any, on the orbit of the shuttle? Explain *briefly*.

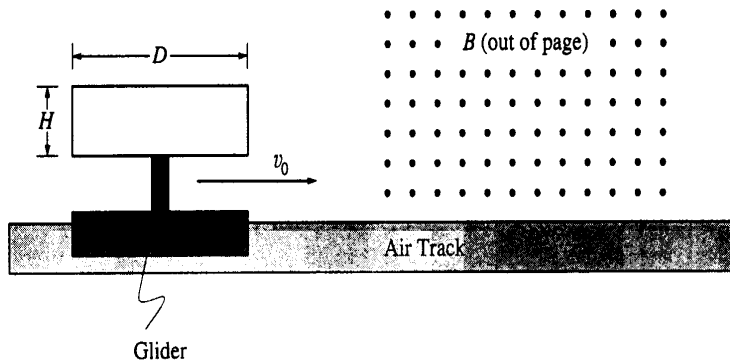

- 1995E3. The long, narrow rectangular loop of wire shown above has vertical height H , length D , and resistance R . The loop is mounted on an insulated stand attached to a glider, which moves on a frictionless horizontal air track with an initial speed of v_0 to the right. The loop and glider have a combined mass m . The loop enters a long, narrow region of uniform magnetic field B , directed out of the page toward the reader. Express your answers to the parts below in terms of B , D , H , R , m , and v_0 .
- What is the magnitude of the initial induced emf in the loop as the front end of the loop begins to enter the region containing the field?
 - What is the magnitude of the initial induced current in the loop?
 - State whether the initial induced current in the loop is clockwise or counterclockwise around the loop.
 - Derive an expression for the velocity of the glider as a function of time t for the interval after the front edge of the loop has entered the magnetic field but before the rear edge has entered the field.
 - Using the axes below, sketch qualitatively a graph of speed v versus time t for the glider. The front end of the loop enters the field at $t = 0$. At t_1 the back end has entered and the loop is completely inside the field. At t_2 the loop begins to come out of the field. At t_3 it is completely out of the field. Continue the graph until t_4 , a short time after the loop is completely out of the field. These times may not be shown to scale on the t -axis below.

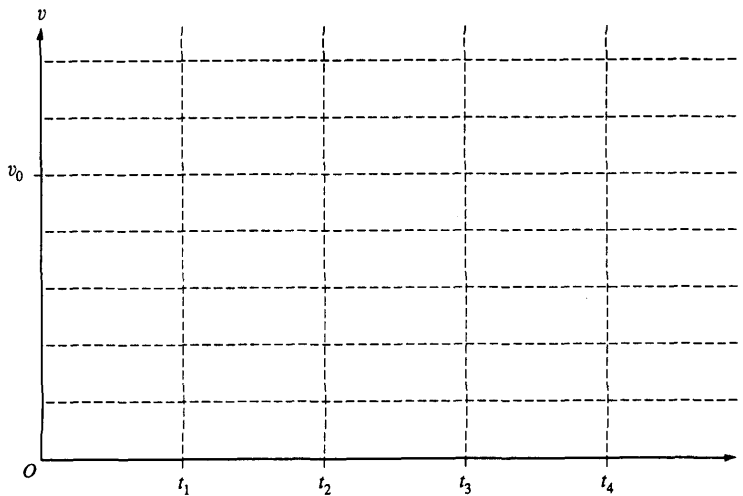

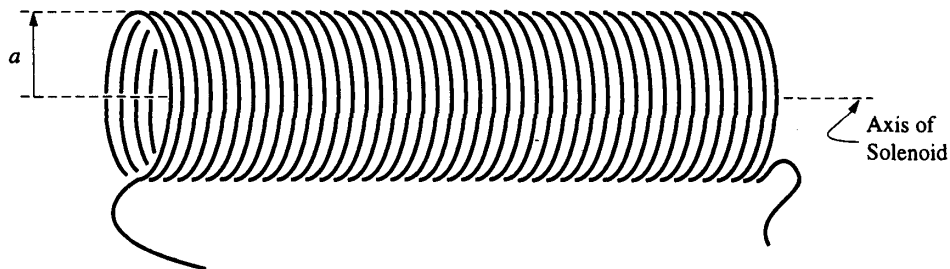

1996E3. According to Faraday's law, the induced emf \mathcal{E} due to a changing magnetic flux ϕ_m is given by $\mathcal{E} = \oint \mathbf{E} \cdot d\mathbf{l} = -d\phi_m / dt$, where E is the (induced) electric field and $d\mathbf{l}$ is a line element along the closed path of integration. A long, ideal solenoid of radius a is shown above. The magnitude of the spatially uniform magnetic field inside this solenoid (due to the current in the solenoid) is increasing at a steady rate dB/dt . Assume that the magnetic field outside the solenoid is zero.

- For $r < a$, where r is the distance from the axis of the solenoid, find an expression for the magnitude E of the induced electric field in terms of r and dB/dt .
- The figure below shows a cross section of the solenoid, with the magnetic field pointing out of the page. On the figure, indicate the direction of the induced electric field at the three labeled points, P_1 , P_2 , and P_3 .

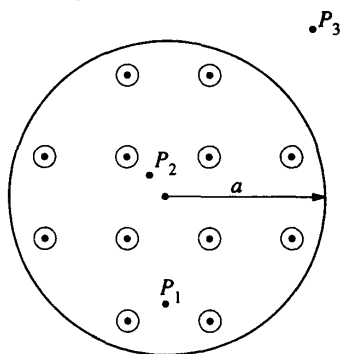

- For $r > a$, derive an expression for the magnitude E of the induced electric field in terms of r , a , and dB/dt .
- On the axes below, sketch a graph of E versus r for $0 \leq r \leq 3a$.

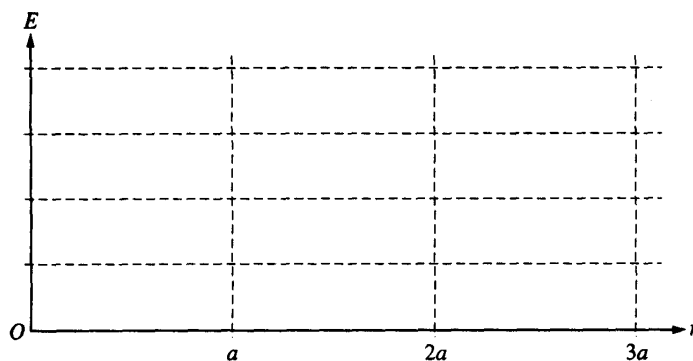



1997E3. A long, straight wire lies on a table and carries a constant current I_0 , as shown above.

- a. Using Ampere's law, derive an expression for the magnitude B of the magnetic field at a perpendicular distance r from the wire.

A rectangular loop of wire of length l , width w , and resistance R is placed on the table a distance s from the wire, as shown below.

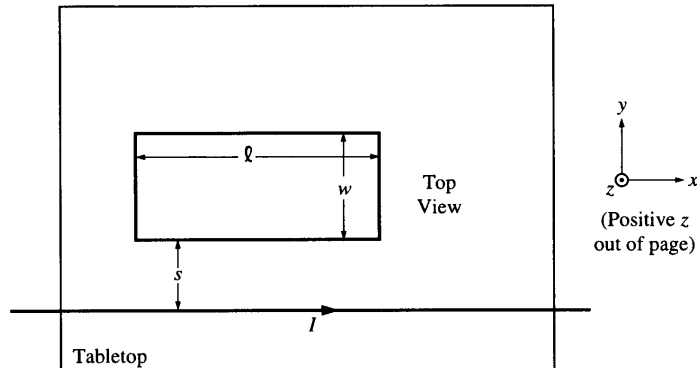

- b. What is the direction of the magnetic field passing through the rectangular loop relative to the coordinate axes shown above on the right?
 c. Show that the total magnetic flux ϕ_m through the rectangular loop is

$$\frac{l\mu_0}{2\pi} \ln \frac{s+w}{s}$$

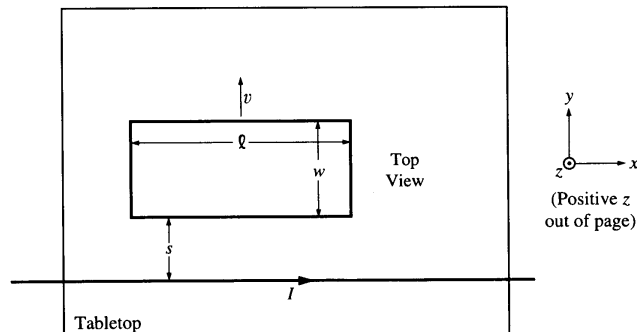

The rectangular loop is now moved along the tabletop directly away from the wire at a constant speed $v = |ds/dt|$ as shown above.

- d. What is the direction of the current induced in the loop? Briefly explain your reasoning.
 e. What is the direction of the net magnetic force exerted by the wire on the moving loop relative to the coordinate axes shown above on the right? Briefly explain your reasoning.
 f. Determine the current induced in the loop. Express your answer in terms of the given quantities and fundamental constants.

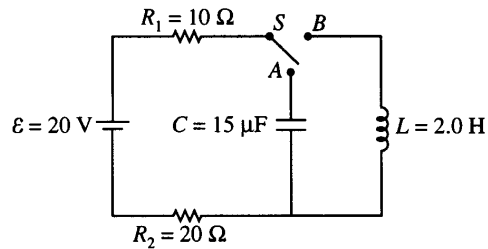

- 1998E2. In the circuit shown above, the switch S is initially in the open position shown, and the capacitor is uncharged. A voltmeter (not shown) is used to measure the correct potential difference across resistor R_1 .
- On the circuit diagram above, draw the voltmeter with the proper connections for correctly measuring the potential difference across resistor R_1 .
 - At time $t = 0$, the switch is moved to position A. Determine the voltmeter reading for the time immediately after $t = 0$.
 - After a long time, a measurement of potential difference across R_1 is again taken. Determine for this later time each of the following.
 - The voltmeter reading
 - The charge on the capacitor
 - At a still later time $t = T$, the switch S is moved to position B. Determine the voltmeter reading for the time immediately after $t = T$.
 - A long time after $t = T$, the current in R_1 reaches a constant final value I_f .
 - Determine I_f .
 - Determine the final energy stored in the inductor.
 - Write, but do not solve, a differential equation for the current in resistor R_1 as a function of time t after the switch is moved to position B.
-

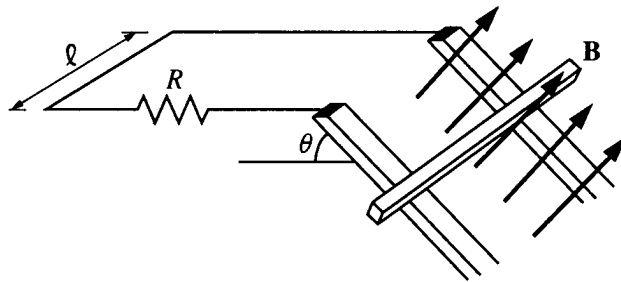

- 1998E3. A conducting bar of mass m is placed on two long conducting rails a distance l apart. The rails are inclined at an angle θ with respect to the horizontal, as shown above, and the bar is able to slide on the rails with negligible friction. The bar and rails are in a uniform and constant magnetic field of magnitude B oriented perpendicular to the incline. A resistor of resistance R connects the upper ends of the rails and completes the circuit as shown. The bar is released from rest at the top of the incline. Express your answers to parts (a) through (d) in terms of m , l , θ , B , R , and g .
- Determine the current in the circuit when the bar has reached a constant final speed.
 - Determine the constant final speed of the bar.
 - Determine the rate at which energy is being dissipated in the circuit when the bar has reached its constant final speed.
 - Express the speed of the bar as a function of time t from the time it is released at $t = 0$.
 - Suppose that the experiment is performed again, this time with a second identical resistor connecting the rails at the bottom of the incline. Will this affect the final speed attained by the bar, and if so, how? Justify your answer.

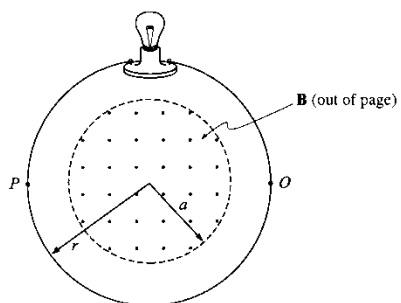

1999E2. A uniform magnetic field \mathbf{B} exists in a region of space defined by a circle of radius $a = 0.60$ m as shown above. The magnetic field is perpendicular to the page and increases out of the page at a constant rate of 0.40 T/s. A single circular loop of wire of negligible resistance and radius $r = 0.90$ m is connected to a light bulb with a resistance $R = 5.0 \Omega$, and the assembly is placed concentrically around the region of magnetic field.

- Determine the emf induced in the loop.
- Determine the magnitude of the current in the circuit. On the figure above, indicate the direction of the current in the loop at point O.
- Determine the total energy dissipated in the light bulb during a 15 s interval.

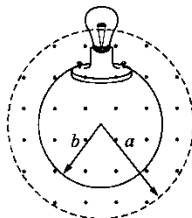

The experiment is repeated with a loop of radius $b = 0.40$ m placed concentrically in the same magnetic field as before. The same light bulb is connected to the loop, and the magnetic field again increases out of the page at a rate of 0.40 T/s. Neglect any direct effects of the field on the light bulb itself.

- State whether the brightness of the bulb will be greater than, less than, or equal to the brightness of the bulb in part (a). Justify your answer.

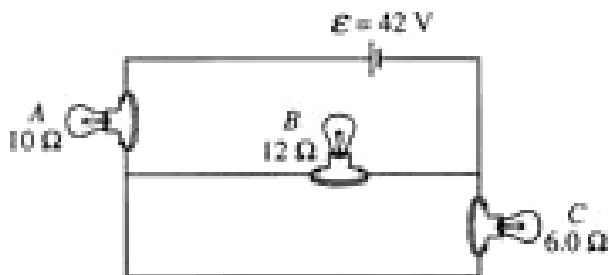

2000E1. Lightbulbs A, B, and C are connected in the circuit shown above.

- a. List the bulbs in order of their brightness, from brightest to least bright. If any bulbs have the same brightness, state which ones. Justify your answer.

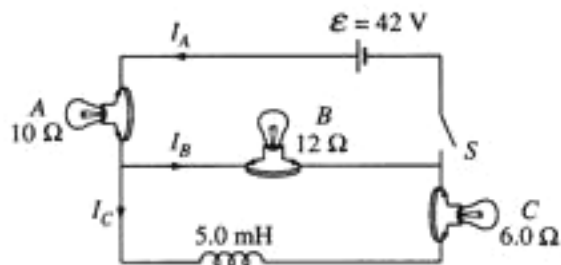

Now a switch S and a 5.0 mH inductor are added to the circuit; as shown above. The switch is closed at time $t = 0$.

- b. Determine the currents I_A , I_B , and I_C for the following times.
- Immediately after the switch is closed
 - A long time after the switch is closed
- c. On the axes below, sketch the magnitude of the potential difference V_L across the inductor as a function of time, from immediately after the switch is closed until a long time after the switch is closed.

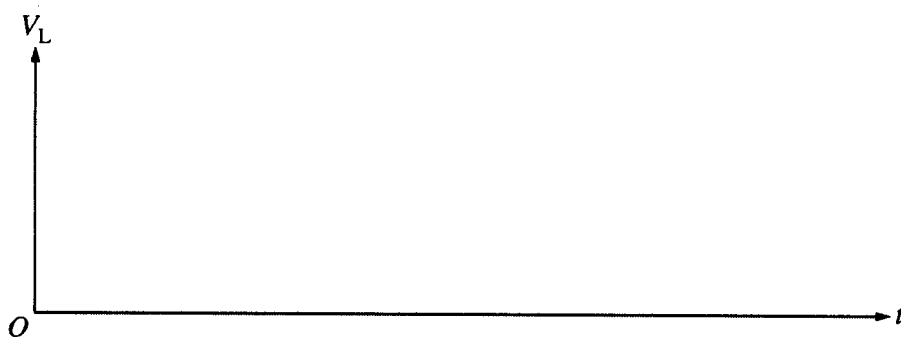

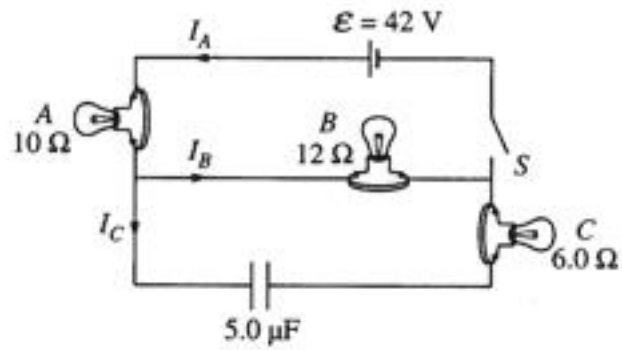

2000E1 [Continued]

- d. Now consider a similar circuit with an uncharged 5.0 μF capacitor instead of the inductor, as shown above. The switch is again closed at time $t = 0$. On the axes below, sketch the magnitude of the potential difference V_{cap} across the capacitor as a function of time, from immediately after the switch is closed until a long time after the switch is closed.

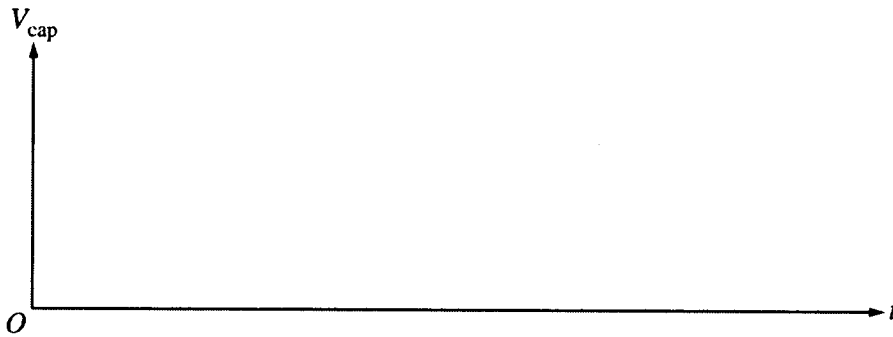

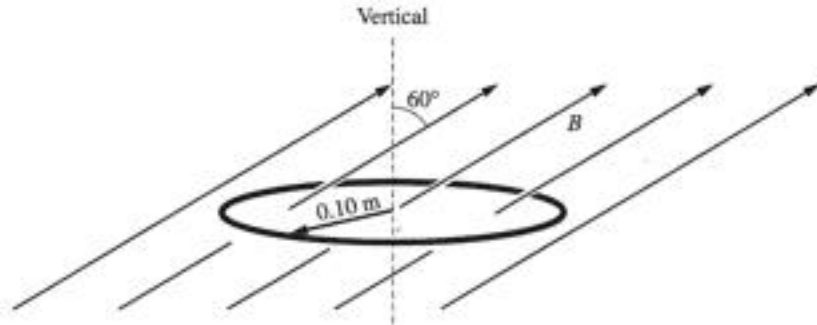

2002E3. A circular wire loop with radius 0.10 m and resistance 50Ω is suspended horizontally in a magnetic field of magnitude B directed upward at an angle of 60° with the vertical, as shown above. The magnitude of the field in teslas is given as a function of time t in seconds by the equation $B = 4(1 - 0.2t)$.

- Determine the magnetic flux Φ_m through the loop as a function of time.
- Graph the magnetic flux Φ_m as a function of time on the axes below.

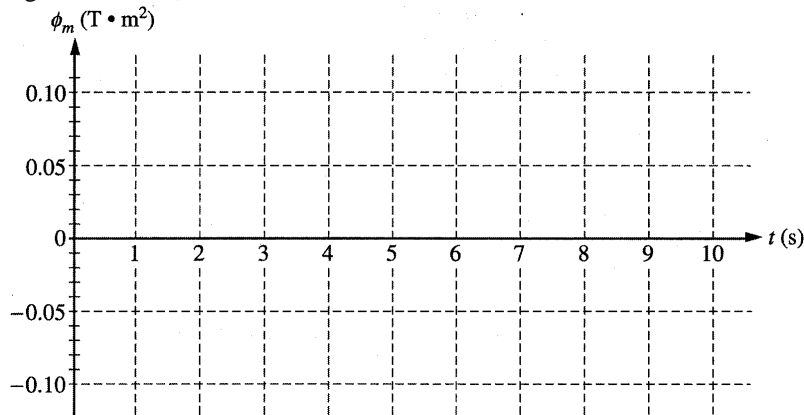

- Determine the magnitude of the induced emf in the loop.
- Determine the magnitude of the induced current in the loop.
 - Show the direction of the induced current on the following diagram

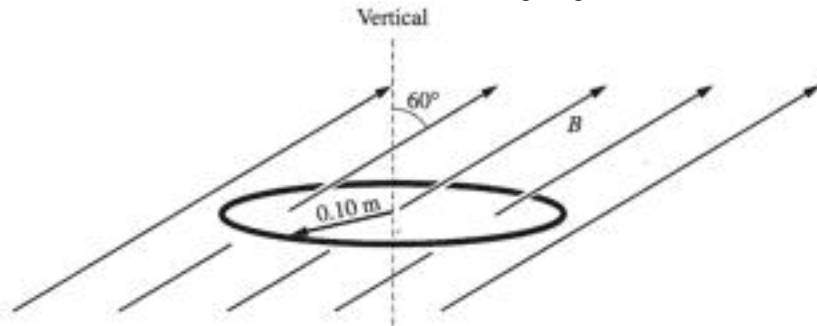

- Determine the energy dissipated in the loop from $t = 0$ to $t = 4$ s

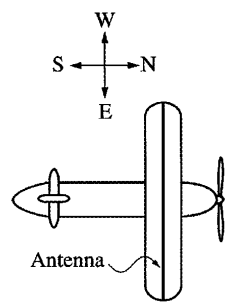

Top View

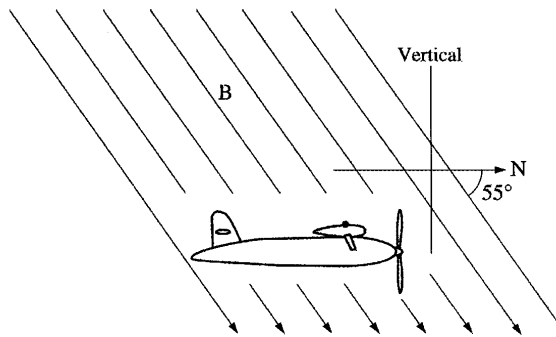

Side View

2003E3. An airplane has an aluminum antenna attached to its wing that extends 15 m from wingtip to wingtip. The plane is traveling north at 75 m/s in a region where Earth's magnetic field has both a vertical component and a northward component, as shown above. The net magnetic field is at an angle of 55 degrees from horizontal and has a magnitude of 6.0×10^{-5} T.

- a. On the figure below, indicate the direction of the magnetic force on electrons in the antenna. Justify your answer.

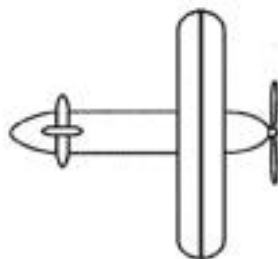

- b. Determine the magnitude of the electric field generated in the antenna.
 c. Determine the potential difference between the ends of the antenna.
 d. On the figure below, indicate which end of the antenna is at higher potential.

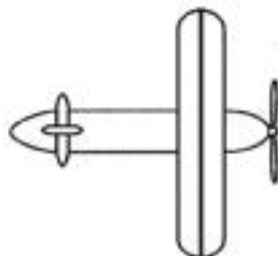

- e. The ends of the antenna are now connected by a conducting wire so that a closed circuit is formed.
 i. Describe the condition(s) that would be necessary for a current to be induced in the circuit. Give a specific example of how the condition(s) could be created.
 ii. For the example you gave in i. above, indicate the direction of the current in the antenna on the figure below.

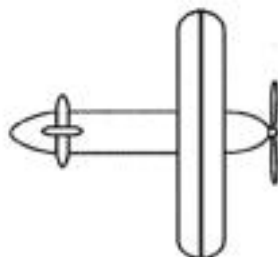

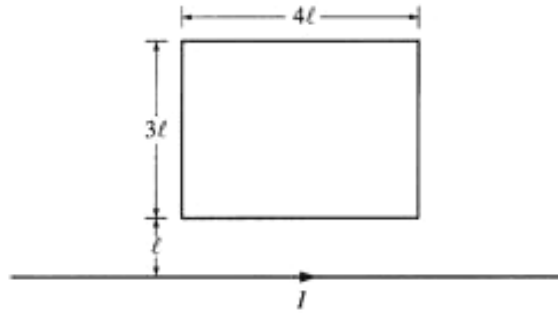

2004E3. A rectangular loop of dimensions 3ℓ and 4ℓ lies in the plane of the page as shown above. A long straight wire also in the plane of the page carries a current I .

- a. Calculate the magnetic flux through the rectangular loop in terms of I , ℓ , and fundamental constants.

Starting at time $t = 0$, the current in the long straight wire is given as a function of time t by

$$I(t) = I_0 e^{-kt}, \text{ where } I_0 \text{ and } k \text{ are constants.}$$

- b. The current induced in the loop is in which direction?

___ Clockwise ___ Counterclockwise
Justify your answer.

The loop has a resistance R . Calculate each of the following in terms of R , I_0 , k , ℓ , and fundamental constants.

- c. The current in the loop as a function of time t
d. The total energy dissipated in the loop from $t = 0$ to $t = \infty$
-

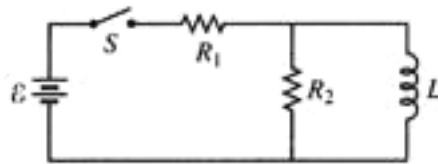

2005E2. In the circuit shown above, resistors 1 and 2 of resistance R_1 and R_2 , respectively, and an inductor of inductance L are connected to a battery of emf ε and a switch S . The switch is closed at time $t = 0$. Express all algebraic answers in terms of the given quantities and fundamental constants.

- a. Determine the current through resistor 1 immediately after the switch is closed.
b. Determine the magnitude of the initial rate of change of current, dI/dt , in the inductor.
c. Determine the current through the battery a long time after the switch has been closed.
d. On the axes below, sketch a graph of the current through the battery as a function of time.

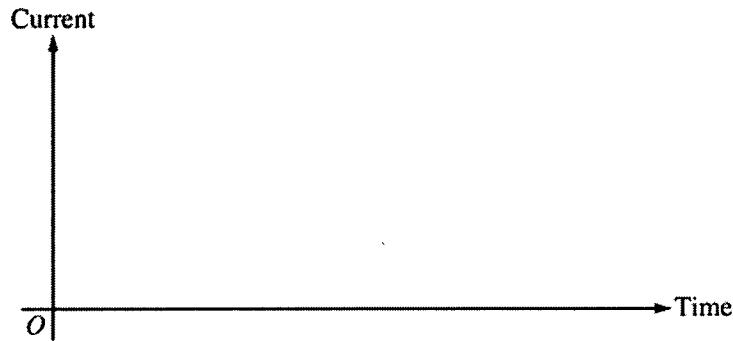

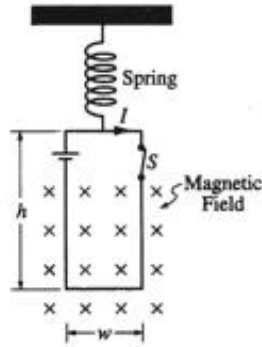

2006E3. A loop of wire of width w and height h contains a switch and a battery and is connected to a spring of force constant k , as shown above. The loop carries a current I in a clockwise direction, and its bottom is in a constant, uniform magnetic field directed into the plane of the page.

- a. On the diagram of the loop below, indicate the directions of the magnetic forces, if any, that act on each side of the loop.



- b. The switch S is opened, and the loop eventually comes to rest at a new equilibrium position that is a distance x from its former position. Derive an expression for the magnitude B_0 of the uniform magnetic field in terms of the given quantities and fundamental constants.

The spring and loop are replaced with a loop of the same dimensions and resistance R but without the battery and switch. The new loop is pulled upward, out of the magnetic field, at constant speed v_0 . Express algebraic answers to the following questions in terms of B_0 , v_0 , R , and the dimensions of the loop.

- c. i. On the diagram of the new loop below, indicate the direction of the induced current in the loop as the loop moves upward.



- ii. Derive an expression for the magnitude of this current.
- d. Derive an expression for the power dissipated in the loop as the loop is pulled at constant speed out of the field.
- e. Suppose the magnitude of the magnetic field is increased. Does the external force required to pull the loop at speed v_0 increase, decrease, or remain the same? .

_____ Increases _____Decreases _____Remains the same

Justify your answer.

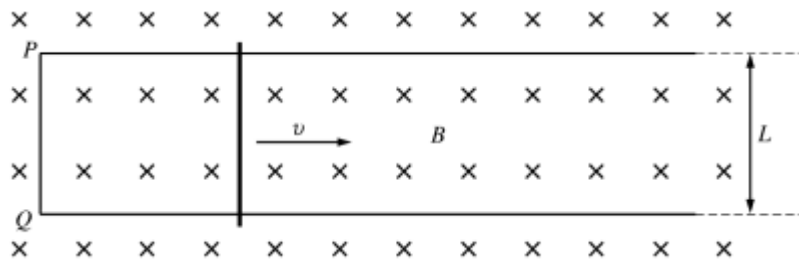

2007E3. In the diagram above, a nichrome wire of resistance per unit length λ is bent at points P and Q to form horizontal conducting rails that are a distance L apart. The wire is placed within a uniform magnetic field of magnitude B pointing into the page. A conducting rod of negligible resistance, which was aligned with end PQ at time $t = 0$, slides to the right with constant speed v and negligible friction. Express all algebraic answers in terms of the given quantities and fundamental constants.

- (a) Indicate the direction of the current induced in the circuit.

_____ Clockwise _____ Counterclockwise

Justify your answer.

- (b) Derive an expression for the magnitude of the induced current as a function of time t .
 (c) Derive an expression for the magnitude of the magnetic force on the rod as a function of time.
 (d) On the axes below, sketch a graph of the external force F_{ext} as a function of time that must be applied to the rod to keep it moving at constant speed while in the field. Label the values of any intercepts.

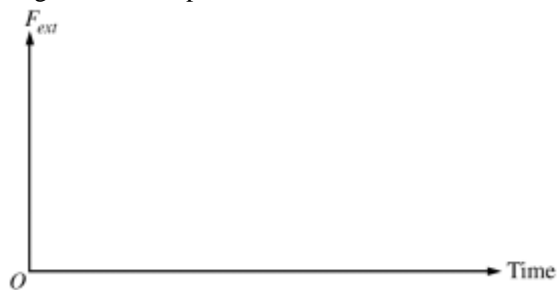

- (e) The force pulling the rod is now removed. Indicate whether the speed of the rod increases, decreases, or remains the same.

_____ Increases _____ Decreases _____ Remains the same

Justify your answer.

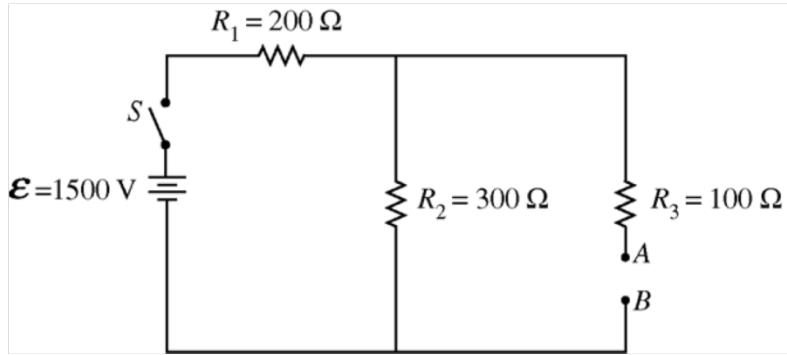

2008E2. In the circuit shown above, A and B are terminals to which different circuit components can be connected.

- (a) Calculate the potential difference across R_2 immediately after the switch S is closed in each of the following cases.
- A $50\ \Omega$ resistor connects A and B .
 - A $40\ \text{mH}$ inductor connects A and B .
 - An initially uncharged $0.80\ \mu\text{F}$ capacitor connects A and B .
- (b) The switch gets closed at time $t = 0$. On the axes below, sketch the graphs of the current in the $100\ \Omega$ resistor R_3 versus time t for the three cases. Label the graphs R for the resistor, L for the inductor, and C for the capacitor.

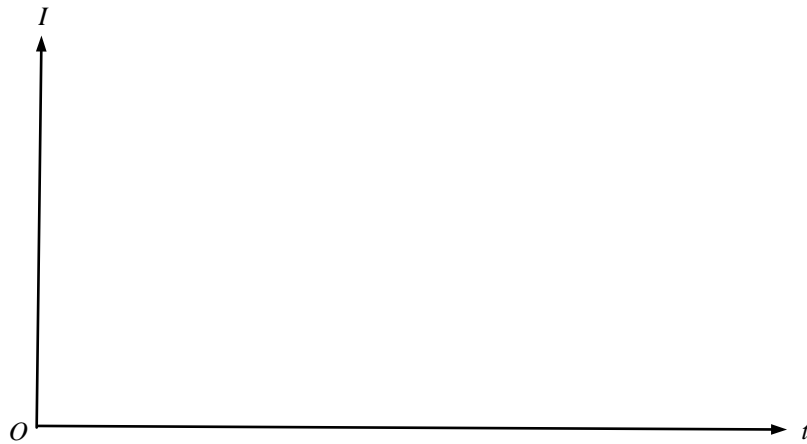

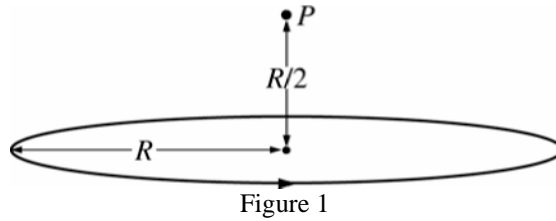

2008E3. The circular loop of wire in Figure 1 above has a radius of R and carries a current I . Point P is a distance of $R/2$ above the center of the loop. Express algebraic answers to parts (a) and (b) in terms of R , I , and fundamental constants.

- (a)
- State the direction of the magnetic field B_I at point P due to the current in the loop.
 - Calculate the magnitude of the magnetic field B_I at point P .

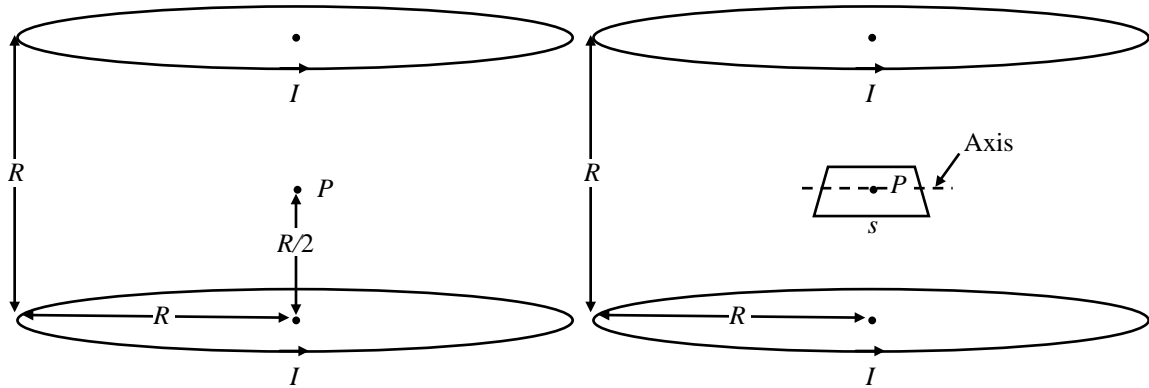
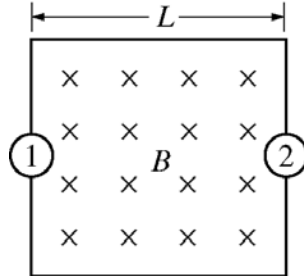

Figure 2

A second identical loop also carrying a current I is added at a distance of R above the first loop, as shown in Figure 2 above.

- (b) Determine the magnitude of the net magnetic field B_{net} at point P .
- A small square loop of wire in which each side has a length s is now placed at point P with its plane parallel to the plane of each loop, as shown in Figure 3 above. For parts (c) and (d), assume that the magnetic field between the two circular loops is uniform in the region of the square loop and has magnitude B_{net} .
- (c) In terms of B_{net} and s , determine the magnetic flux through the square loop.
- (d) The square loop is now rotated about an axis in its plane at an angular speed ω . In terms of B_{net} , s , and ω , calculate the induced emf in the loop as a function of time t , assuming that the loop is horizontal at $t = 0$.

Figure 3



2009E3.

A square conducting loop of side L contains two identical lightbulbs, 1 and 2, as shown above. There is a magnetic field directed into the page in the region inside the loop with magnitude as a function of time t given by $B(t) = at + b$, where a and b are positive constants. The lightbulbs each have constant resistance R_0 . Express all answers in terms of the given quantities and fundamental constants.

- Derive an expression for the magnitude of the emf generated in the loop.
- Determine an expression for the current through bulb 2.
 - Indicate on the diagram above the direction of the current through bulb 2.
- Derive an expression for the power dissipated in bulb 1.

Another identical bulb 3 is now connected in parallel with bulb 2, but it is entirely outside the magnetic field, as shown below.

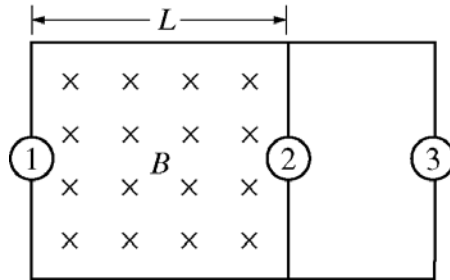

- How does the brightness of bulb 1 compare to what it was in the previous circuit?
 ___ Brighter ___ Dimmer ___ The same
 Justify your answer.

Now the portion of the circuit containing bulb 3 is removed, and a wire is added to connect the midpoints of the top and bottom of the original loop, as shown below.

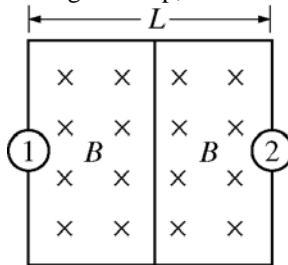

- How does the brightness of bulb 1 compare to what it was in the first circuit?
 ___ Brighter ___ Dimmer ___ The same
 Justify your answer.

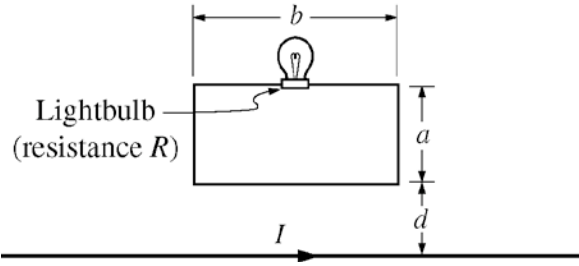

2010E3. The long straight wire illustrated above carries a current I to the right. The current varies with time t according to the equation $I = I_0 - Kt$, where I_0 and K are positive constants and I remains positive throughout the time period of interest. The bottom of a rectangular loop of wire of width b and height a is located a distance d above the long wire, with the long wire in the plane of the loop as shown. A lightbulb with resistance R is connected in the loop. Express all algebraic answers in terms of the given quantities and fundamental constants.

- Indicate the direction of the current in the loop.
 Clockwise Counterclockwise
 Justify your answer.
- Indicate whether the lightbulb gets brighter, gets dimmer, or stays the same brightness over the time period of interest.
 Gets brighter Gets dimmer Remains the same
 Justify your answer.
- Determine the magnetic field at $t = 0$ due to the current in the long wire at distance r from the long wire.
- Derive an expression for the magnetic flux through the loop as a function of time.
- Derive an expression for the power dissipated by the lightbulb.

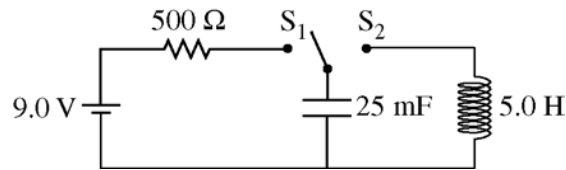

2011E2. The circuit represented above contains a 9.0 V battery, a 25 mF capacitor, a 5.0 H inductor, a 500 Ω resistor, and a switch with two positions, S_1 and S_2 . Initially the capacitor is uncharged and the switch is open.

- (a) In experiment 1 the switch is closed to position S_1 at time t_1 and left there for a long time.
- Calculate the value of the charge on the bottom plate of the capacitor a long time after the switch is closed.
 - On the axes below, sketch a graph of the magnitude of the charge on the bottom plate of the capacitor as a function of time. On the axes, explicitly label any intercepts, asymptotes, maxima, or minima with numerical values or algebraic expressions, as appropriate.

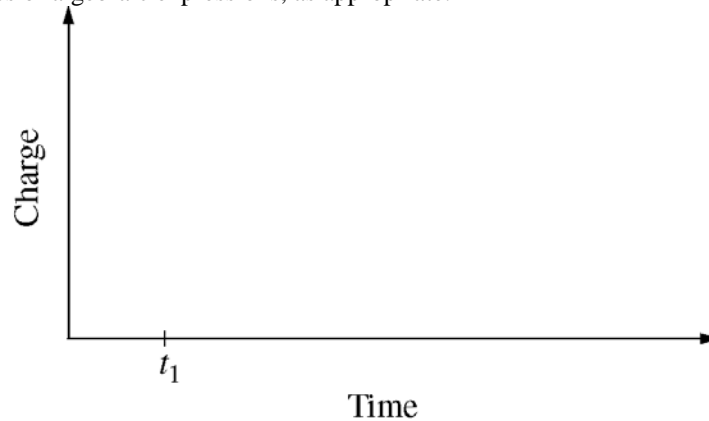

- On the axes below, sketch a graph of the current through the resistor as a function of time. On the axes, explicitly label any intercepts, asymptotes, maxima, or minima with numerical values or algebraic expressions, as appropriate.

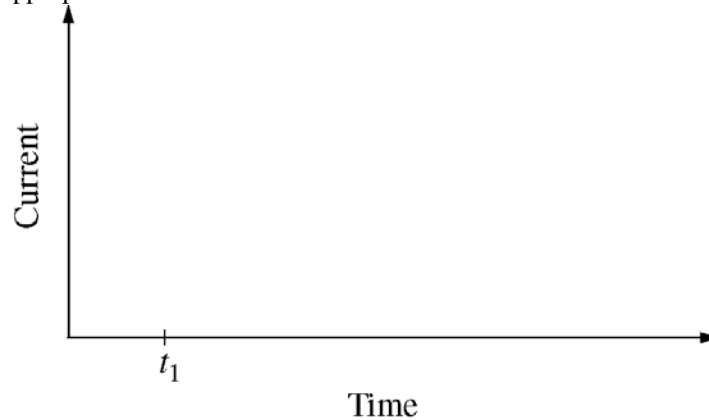

- (b) In experiment 2 the capacitor is again uncharged when the switch is closed to position S_1 at time t_1 . The switch is then moved to position S_2 at time t_2 when the magnitude of the charge on the capacitor plate is 105 mC, allowing electromagnetic oscillations in the LC circuit.
- Calculate the energy stored in the capacitor at time t_2 .
 - Calculate the maximum current that will be present during the oscillations.
 - Calculate the time rate of change of the current when the charge on the capacitor plate is 50 mC.

SECTION A – MagnetostaticsSolutionAnswer

For the purposes of this solution guide. The following hand rules will be referred to.

RHR means right hand rule (for + current). LHR will be substituted for – current

RHR (Ampere)

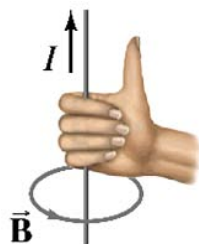

RHR (force)

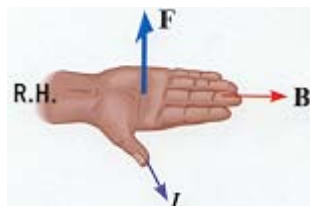

RHR (Solenoid)

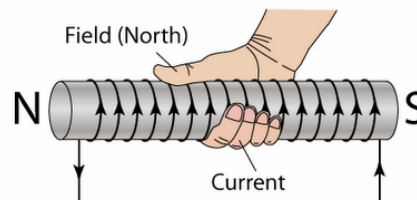

- RHR (force), since electrons drift east, we can consider conventional current flowing west. With the thumb of your right hand west and fingers pointing north (along B), the palm faces vertically downward E
- Since the particle is moving parallel to the field it does not cut across lines and has no force. D
- The electric force would act upwards on the proton so the magnetic force would act down. Using RHR (force), the B field must point out of the page D
- $F_e = F_b$ $Eq = qvB$ $E = vB$ $B = E/v$ A
- Magnetic fields do no work on charged particles as the force is perpendicular to the displacement E
- RHR (force) E
- Based on ... $F_{\text{net}(C)} = mv^2/r$... $F_b = mv^2/r$... $qvB = mv^2/r$... $r = mv/qB$... inverse B
- Isolating poles/charges is Gauss's Law. In magnetic form, Gauss's Law is $\int \mathbf{B} \cdot d\mathbf{A}$ and the absence of magnetic monopoles leads to the integral equal to zero C
- Based on the axis given. The left side wire is on the axis and makes no torque. The top and bottom wires essentially cancel each other out due to opposite direction forces, so the torque can be found from the right wire only. Finding the force on the right wire ...
 $F_b = BIL = (0.05)(2)(0.3) = .03 \text{ N}$, then torque = $Fr = (0.03)(0.3)$ B
- When a particle has components parallel and perpendicular to a magnetic field, the perpendicular component will lead to circular motion while the parallel component will remain unchanged, leading to a forward moving circular path around the field line D
- Using RHR(force) for the magnetic field direction given, the magnetic force would be up (+z). To counteract this upwards force on the + charge, the E field would have to point down (-z). E
- First we have ... $F_{\text{net}(C)} = mv^2/r$... $F_b = mv^2/r$... $qvB = mv^2/r$... $v = qBr/m$
Then using $v = 2\pi R / T$ we have $qBr/m = 2\pi R / T$... radius cancels so period is unchanged and frequency also is unaffected by the radius. Another way to think about this with the two equations given above is: by increasing R, the speed increases, but the $2\pi R$ distance term increases the same amount so the time to rotate is the same A
- Pick any small segment of wire. The force should point to the center of the circle. For any small segment of wire, use RHR (force) and you get velocity direction is CCW. Equation is the same as the problem above ... $qvB = mv^2/r$... $eBr = mv$ C

14. Same as in question 12 ... $qBr/m = 2\pi R / T \dots T = 2\pi m / eB$ C
15. A little tricky since its talking about fields and not forces. To move at constant velocity the magnetic FORCE must be opposite to the electric FORCE. Electric fields make force in the same plane as the field (ex: a field in the x plane makes a force in the x plane), but magnetic fields make forces in a plane 90 degrees away from it (ex: a field in the x plane can only make magnetic forces in the y or z plane). So to create forces in the same place, the fields have to be perpendicular to each other B
16. The left and right sides of the loop wires are parallel to the field and experience no forces. Based on RHR (force), the top part of the loop would have a force out of the page and the bottom part of the loop would have a force into of the page which rotates as in choice C C
17. With electrons drifting toward the bottom of the page and a magnetic field into the page, the left hand rule for forces give a force on the electrons toward the left. This would cause the left side of the copper sheet to acquire a negative charge, a lower potential than the right side. B

SECTION B – Biot Savart and Ampere’s Law

18. The force on either wire is $F_b = (\mu_o I_a / 2\pi R) I_b L$ D
19. In a cylindrical wire with a uniform current, B is proportional to r inside the wire and proportional to 1/r outside the wire A
20. For long (ideal) solenoids, $B = \mu_o In$, there is no dependence on radius C
21. Using RHR (Ampere) for each wire, the left wire makes a field pointing down&right at P and the right wire makes a field pointing up&right. The up and down parts cancel leaving only right E
22. In a cylindrical wire with a uniform current, B is proportional to r inside the wire and proportional to 1/r outside the wire E
23. Wires with current flowing in the same direction attract B
24. $F_b = (\mu_o I_a / 2\pi R) I_b L \dots R$ is $\times 2$ and both I’s are $\times 2$ so it’s a net effect of $\times 2$ D
25. Using RHR (Solenoid), the B field at the center of that loop is directed right. Since the other loop is further away, its direction is irrelevant at the left loop will dominate C
26. For long (ideal) solenoids, $B = \mu_o In$, there is no dependence on radius E
27. The field from a single wire is given by $\mu_o I_a / 2\pi R$. The additional field from wire Y would be based on this formula with $R = 3R$, so in comparison it has 1/3 the strength of wire X. So adding wire X’s field B_o + the relative field of wire Y’s of 1/3 B_o gives a total of 4/3 B_o D
28. Using dimensional analysis: meters/second = meters/proton \times protons/coulomb \times coulombs/second = current \div charge of a proton \div protons per meter = $1.6 \times 10^{-3} \div 1.6 \times 10^{-19} \div 10^9$ D
29. By RHR (Ampere) A
30. First we use RHR (Ampere) to find the B field above the wire as into the page, and we note that the magnitude of the B field decreases as we move away from it. Since the left AB and right CD wires are sitting in the same average value of B field and have current in opposite directions, they repel each other and those forces cancel out. Now we look at the wire AD closest to the wire. Using RHR (force) for this wire we get down as a force. The force on the top wire BC is irrelevant because the top and bottom wires have the same current but the B field is smaller for the top wire so the bottom wire will dominate the force direction no matter what. Therefore, the direction is down towards the wire A

31. Like Gauss's Law, Ampere's Law is useful for certain geometries where the magnetic field is of a particular special nature that lends itself to a line integral easily. Choices A and B have zero magnetic fields and choices D and E do not have magnetic fields that are easily integrable C
32. The path integral around the Amperian loop is $2\pi r$. Inside a wire, the current enclosed in our Amperian loop is proportional to the fractional area enclosed ($\pi r^2/\pi R^2$) B
33. $F = \mu_0 I_1 I_2 L / 2\pi d$ C
34. Each wire creates a magnetic field around itself. Since all the currents are the same, and wire Y is closer to wire X, wire X's field will be stronger there and dominate the force on wire Y. So we can essentially ignore wire Z to determine the direction of the force. Since X and Y are in the same direction they attract and Y gets pulled to the left E

SECTION C – Induction and Inductance

35. As long as the flux inside the loop is changing, there will be an induced current. Since choice E has both objects moving in the same direction, the flux through the loop remains constant so no need to induce a current E
36. Since the bar is not cutting across field lines and has no component in a perpendicular direction to the field line there will be no induced emf B
37. As you enter the region, flux into the page is gained. To counteract that, current flows to create a field out of the page to maintain flux. Based on RHR–solenoid, that current is CCW. When leaving the region, the flux into the page is decreasing so current flows to add to that field which gives CW A
38. When establishing a current through an inductor, the back emf initially opposes all current so the current (and V_R) is zero. Over time the current (and V_R) increases to its steady value as the back emf reduces to zero B
39. First use $\mathcal{E} = \Delta\Phi / t$ $\mathcal{E} = (BA_f - BA_i) / t$ $\mathcal{E} = (0 - (0.4)(0.5 \times 0.5)) / 2$ $\mathcal{E} = 0.05 \text{ V}$
 Then use $V = IR$ $0.05 \text{ V} = I(0.01)$ $I = 5 \text{ A}$
 Direction is found with Lenz law. As the field out decreases, the current flows to add outward field to maintain flux. Based on RHR–solenoid, current flows CCW B
40. Voltage = $L(dI/dt)$ so $1 \text{ H} = \text{V}\cdot\text{s}/\text{A}$ and $1 \Omega = 1 \text{ V}/\text{A}$ so $1 \text{ H}/1 \Omega = \text{V}\cdot\text{s}/\text{A} \div \text{V}/\text{A}$ E
41. Loop 2 initially has zero flux. When the circuit is turned on, current flows through loop 1 in a CW direction, and using RHR–solenoid it generates a B field down towards loop 2. As the field lines begin to enter loop 2, loop 2 has current begin to flow based on lenz law to try and maintain the initial zero flux so it makes a field upwards. Based on RHR–solenoid for loop 2, current would have to flow CCW around that loop which makes it go from X to Y A
42. After a long time, the flux in loop 2 becomes constant and no emf is induced so no current flows. In circuit 1, the loop simply acts as a wire and the current is set by the resistance and $V = IR$ C
43. From Ampere-Maxwell's equation, the effect of a changing electric field between the plates of a charging capacitor are identical in the production of a magnetic field as a current through a wire (this is the displacement current) and is proportional to this rate of change as it is proportional to a current. B
44. When establishing a current through an inductor, the back emf initially opposes all current so the current through that branch is zero A

45. After steady current has been established, the inductor has no more effect on the currents in the circuit and acts as if it were not present B
46. When the switch is opened, the inductor keeps the existing current (opposing the change), but as the energy in the inductor diminishes, the current decays to zero asymptotically E
47. As the magnet moves down, flux increase in the down direction. Based on Lenz law, current in the loop would flow to create a field upwards to cancel the increasing downwards field. Using RHR–solenoid, the current would flow CCW. Then, when the magnet is pulled upwards, you have downward flux lines that are decreasing in magnitude so current flows to add more downward field to maintain flux. Using RHR–solenoid you now get CW E
48. Since the wire is not cutting across the field lines, there is no force and no charge separation E
49. $I = \mathcal{E}/R = (dB/dt)A/R = bL^2/R$. Since the field is decreasing in strength over time (that is, increasing into the page) the induced current will establish a field pointing out of the page to oppose this change and by RHR-solenoid, this is counterclockwise E
50. By RHR-solenoid, the current loop establishes a south pole on the side near the magnet, attracting it A
51. $\mathcal{E} = (-dB/dt)A$ so $B = -(1/A)\int E dt = -(1/A)\int bAt^{1/2} dt$ E
52. If $R = at$, the area is $A = \pi R^2 = \pi a^2 t^2$ and the induced emf is $B(dA/dt) = B(2\pi a^2 t)$ A
53. As the loop is pulled to the right, it loses flux lines right so current is generated by Lenz law to add more flux lines right. This newly created field to the right from the loop is in the same direction as the magnetic field so makes an attractive force pulling the magnet right also A
54. $\int E ds$ is potential difference. A potential difference equal to the rate of change of some flux is Faraday's Law, which involves magnetic flux. A
55. After steady current has been established, the inductor has no more effect on the currents in the circuit and acts as if it were not present C
56. When establishing a current through an inductor, the back emf initially opposes all current so the current (and V_R) is zero A

SECTION A – Magnetostatics

1976E3

- In order to move in a uniform circular path, the force must be directed toward the center of the circle.
 - Because the particle experiences an upward magnetic force while traveling to the right in a magnetic field pointing out of the page, it is the LHR that provides the correct direction, which indicates a negative charge.
 - The magnetic force acts up and the electric force acts down
 - As there is no acceleration in region I, the net force must be zero, so the magnetic force is equal to the electric force: $qvB = qE$, or $v = E/B$
 - In the circular region $F = mv^2/r = qvB$ with $v = E/B$, giving $m = B^2qR/E$
-

1977E3

- Counterclockwise. The current flows radially outward, use RHR (force)
 - $\tau = rF$ for each spoke and let $r =$ center of mass of each spoke:
 $Nr(BIL) = (6)(0.1 \text{ m})(0.5 \text{ T})(6 \text{ A})(0.2 \text{ m}) = 0.06 \text{ N}\cdot\text{m}$
-

1978E1

- $\Delta U = \Delta K$
 $qV_g = \frac{1}{2}mv_e^2$ giving $v_e = (2eV_g/m)^{1/2}$
- Total energy upon entering = total energy at y_{\max}
 $\frac{1}{2}mv_e^2 = \frac{1}{2}mv_e^2\cos^2\theta + e(V_p/d)y_{\max}$ where the second term is from $W = qEd$
 thus $y_{\max} = d(V_g/V_p)\sin^2\theta$
- The speed at impact is unchanged, the magnetic force is always 90° to the velocity and thus does no work
-

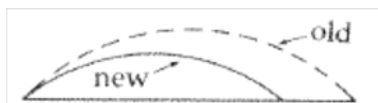

Along the old path, the magnetic force always had a downward component, thus y_{\max} is lower and the time of flight shorter.

1979E3

- Experiment I demonstrated that B is in the plane of the page because F is perpendicular to both v and B . Experiment II demonstrates that B makes an angle of -60° (to the x axis) in the plane of the paper since it must be perpendicular to F_2
 - For the motion to be purely circular F must be perpendicular to v and the force is constant, while v is also perpendicular to B , this is case II. Since $F = mv^2/r$ we have $r = mv^2/F$
 - Since v is not perpendicular to B , the component of v parallel to v produces no force and hence no change in motion. The perpendicular component of the velocity produces circular motion. The resulting motion is spiral (helix) about the B vector.
-

1984E1

- a. $q\mathcal{E} = \frac{1}{2}mv^2$ gives $\mathcal{E} = mv^2/2e$
 b. and d.ii.

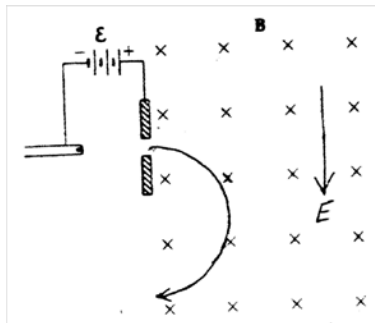

- c. $F_B = mv^2/r$
 $r = mv/eB$
 d. i. $F_E = F_B$; $qE = qvB$ giving $E = vB$
-

1990E2

- a. Based on the RHR, the magnetic force on the + charge is down, so the electric force should point up. For + charges, and E field upwards would be needed to make a force up.
 b. The speed on region III is equal the whole time and is the same as the speed of the particles in region II. For region II we have ... $F_e = F_b$... $Eq = qvB$... $v = E/B$
 c. Using region III ... $F_{\text{net}(C)} = mv^2/r$... $qvB = mv^2/r$... $m = QBR/v$ (sub in v) ... $= QB^2R/E$
 d. In between the plates, $W = K$... $Vq = \frac{1}{2}mv^2$... $V = mv^2/2Q$... (sub in v and m) ... $= RE/2$
 e. In region three, the acceleration is the centripetal acceleration. $a_c = v^2/R$... (sub in v) ... E^2/RB^2
 f. Time of travel can be found with $v = d/t$ with the distance as half the circumference ($2\pi R/2$) then sub in v giving ... $t = \pi RB/E$
-

1993E3

- a. The magnetic force provides the centripetal force. By RHR (force) we get B points into the page or -z
 b. Between the plates, the electric field must exert a force opposite to the magnetic force. The magnetic force is to the right so the electric force must point to the left and since the charge is positive, the field must also point to the left. Therefore, plate K should have a positive polarity with respect to plate L
 c. $E = V/d = (1500 \text{ V})/(0.012 \text{ m}) = 1.25 \times 10^5 \text{ V/m}$
 d. $F_E = F_B$; $qE = qvB$ giving $v = E/B = 6.25 \times 10^5 \text{ m/s}$
 e. $F_B = mv^2/R = qvB$ giving $m = qBR/v = 2.56 \times 10^{-26} \text{ kg}$
 f. Using the equation from (e) and solving for R gives $R = mv/qB$. Replacing q with 2q gives $R' = R/2 = 0.25 \text{ m}$
-

2009E2

a. $R = \rho L/A = 7.2 \Omega$ and $P = V^2/R = 11 \text{ W}$

b.

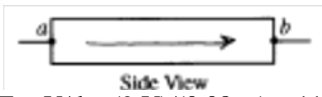

c. $E = V/d = (9 \text{ V})/(0.08 \text{ m}) = 110 \text{ V/m}$

d. $F = ILB = VLB/R = 0.025 \text{ N}$

e.

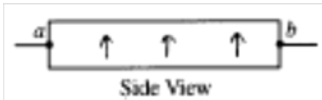

f. $F_E = F_B$; $qE = qvB$ giving $E = vB = 8.8 \times 10^{-4} \text{ V/m}$

SECTION B – Biot Savart and Ampere’s Law

1979E2

a.

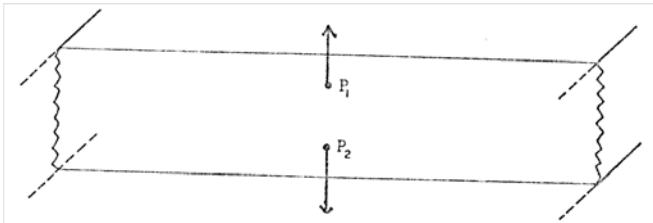

b.

$$\oint E \cdot dA = \frac{Q_{enc}}{\epsilon_0}$$

Choose a pill-box with a top and bottom area A . Let the top face pass through P_1 and the bottom through P_2 . By symmetry, E is perpendicular to both ends, is directed outward and is of equal magnitude (and parallel to the sides). $Q_{enc} = \rho(2a)(A)$ Thus $2EA = \rho(2a)(A)/\epsilon_0$ giving $E = \rho a/\epsilon_0$

c.

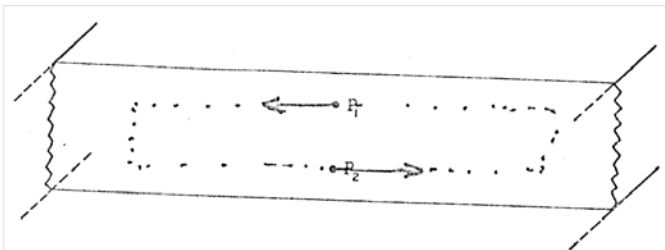

d.

$$\oint \vec{B} \cdot d\vec{l} = \mu_0 i_{enc}$$

Choose a rectangular path of length L and width $2a$ with the top and bottom through P_1 and P_2 . By symmetry, B is parallel to both the top and bottom, is in the same direction as the path increment and is normal to the ends $2BL = \mu_0 i = \mu_0 j 2AL$ giving $B = \mu_0 a j$

1981E2

- E points to the right, along the axis
- From each small charge element $dE = kdq/r^2$ and we only consider the axial components, that is $dE \cos \theta$ where $\cos \theta = b/(a^2 + b^2)^{1/2}$ and since each point of the ring is the same distance we only integrate dq to Q giving $E = kbQ/(a^2 + b^2)^{3/2}$
- $I = Q/T = Q/(2\pi/\omega) = Q\omega/2\pi$
- By RHR (ampere) the field points axially to the left
- By the RHR and symmetry, we know that the NET B is to the left. Thus only the horizontal component of B is important. To find the angle, let us examine the top portion of the ring. The straight line r vector from this portion to P is at an angle of theta ($\cos \theta = a/r$) from the vertical. The field at P due to this top portion is perpendicular to this r vector--down and to the left, at the same angle θ , but from the horizontal. Thus the only component of dB that is important is $dB \cos \theta = dB \times a/(a^2 + b^2)^{1/2}$
 $dB_x = \mu_0 Idl/4\pi(a^2 + b^2)$ where $dl = a d\theta$. And $I d\theta = Q d\theta/dt = Q\omega$ which gives $B = \mu_0 \omega a^2 Q/4\pi(a^2 + b^2)^{3/2}$

1983E3

a.

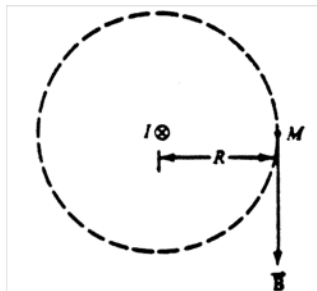

The field at M is down, the path of integration is a circle around I.

$$\oint \vec{B} \cdot d\vec{l} = \mu_0 i_{enc}$$

Applied to the circular path gives $B(2\pi R) = \mu_0 I$ so that $B = \mu_0 I/2\pi R$

- The field from a wire is given by $B = \mu_0 I / (2\pi R)$, with R and I equal for both wires at point O. Based on the RHR for the current wires, the right wire makes a field down and the left wire makes a field up so cancel to zero.

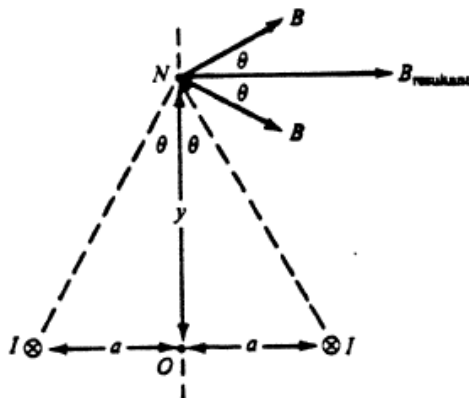

- Based on the RHR, the resultant fields from each wire are directed as shown. Since the distance to each wire is the same, the resultant B field will simply be twice the x component of one of the wire's B fields.

The distance to point N is $\sqrt{a^2 + y^2}$ so the total field at that location from a single wire is

$$B = \frac{\mu_0 I}{2\pi \sqrt{a^2 + y^2}}$$

The x component of that field is given by $B \cos \theta$, where $\cos \theta$ can be replaced with $\cos \theta = a/h = y/\sqrt{a^2 + y^2}$

$$\text{Giving } B_{net} = 2 B \cos \theta = 2 B \frac{y}{\sqrt{a^2 + y^2}} = \frac{2y\mu_0 I}{2\pi \sqrt{a^2 + y^2} \sqrt{a^2 + y^2}} = \frac{y\mu_0 I}{\pi(a^2 + y^2)}$$

1993E1

a.

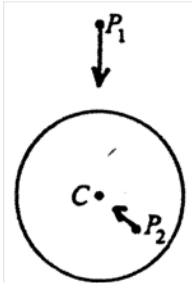

b. i.

$$\oint E \cdot dA = \frac{Q_{enc}}{\epsilon_0}$$

For $r > R$ using a Gaussian surface that is a cylinder of radius r and length L , $Q_{enc} = \rho(\pi R^2 L)$

$E(2\pi r L) = \rho(\pi R^2 L)/\epsilon_0$ so $E = \rho R^2/2\epsilon_0 r$

ii. For $r < R$, use a similar Gaussian surface as above and $Q_{enc} = \rho(\pi r^2 L)$

$E(2\pi r L) = \rho(\pi r^2 L)/\epsilon_0$ so $E = \rho r/2\epsilon_0$

c.

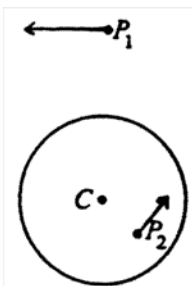

d.

$$\oint \vec{B} \cdot d\vec{l} = \mu_0 i_{enc}$$

Where I_{enc} is the current enclosed by the closed Amperian loop (current density times area) $= (I/\pi R^2)(\pi r^2)$

For $r < R$: $B(2\pi r) = \mu_0(I/\pi R^2)(\pi r^2)$ gives $B = \mu_0 I r/2\pi R^2$

1994E3

a.

$$\oint \vec{B} \cdot d\vec{l} = \mu_0 i_{enc}$$

Where I_{enc} is the current enclosed by the closed Amperian loop (current density times area) = $(I/\pi a^2)(\pi r^2)$

i. For $r < a$: $B(2\pi r) = \mu_0(I/\pi a^2)(\pi r^2)$ gives $B = \mu_0 I r / 2\pi a^2$

ii. For $a < r < b$: $B(2\pi r) = \mu_0 I$ gives $B = \mu_0 I / 2\pi r$

b. For $r > c$ the net current enclosed is zero therefore the field is also zero

c.

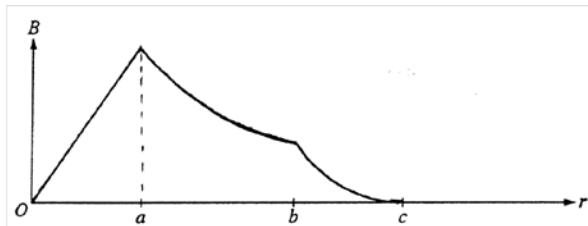

d. i. $F = qvB = qv\mu_0 I / 2\pi r$

ii.

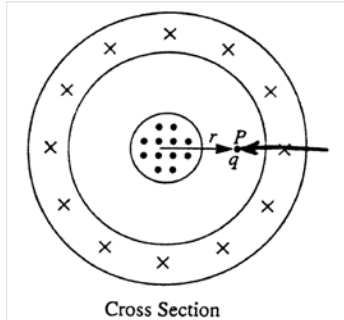

e. The answers to (d) would not change, only the current inside the radius r has any effect on the magnetic field and hence, the charge

2000E3

a. i.

$$\oint E \cdot dA = \frac{Q_{enc}}{\epsilon}$$

Where we have replaced ϵ_0 with $\epsilon = \kappa\epsilon_0$

$$E(2\pi rL) = Q/\kappa\epsilon_0$$

$$E = Q/2\pi\kappa\epsilon_0 rL$$

ii. $E = 0$ (net charge enclosed is zero)

b. i. $\Delta V = \int E dr = (Q/2\pi\kappa\epsilon_0 L) \int dr/r$ (limits from a to b) = $(Q/2\pi\kappa\epsilon_0 L) \ln(b/a)$

ii. $C = Q/\Delta V = 2\pi\kappa\epsilon_0 L / \ln(b/a)$

c. i.

$$\oint \vec{B} \cdot d\vec{l} = \mu_0 i_{enc}$$

$$B(2\pi r) = \mu_0(\mathcal{E}/R) \text{ gives } B = \mu_0 \mathcal{E} / 2\pi r R$$

$$\text{ii. } B(2\pi r) = \mu_0(4\mathcal{E}/R) \text{ gives } B = 2\mu_0 \mathcal{E} / \pi r R$$

2001E3

- $I = \mathcal{E}/R$ the current flows clockwise, or to the left through the rod
- Currents in opposite directions repel so the current in the cable must be to the right
- $F = IIB = mg = I_c l \mu_0 \mathcal{E} / 2\pi r R$ giving $I_c = 2\pi mgrR / \mu_0 l \mathcal{E}$
- $\phi = \int B dA$ where $B = \mu_0 I_c / 2\pi x$ and x is the vertical distance from the cable and $dA = l dx$

$$\phi = \int_r^{r+d} \frac{\mu_0 2\pi mgrR l}{2\pi \mu_0 l \varepsilon} \frac{dx}{x} = \frac{mgrR}{\varepsilon} \ln x \Big|_r^{r+d} = \frac{mgrR}{\varepsilon} \ln \left(\frac{r+d}{r} \right)$$

2005E3

a.

Trial	Position of End Q (cm)	Measured Magnetic Field (T) (directed from P to Q)	n (turns/m)
1	40	9.70×10^{-4}	250
2	50	7.70×10^{-4}	200
3	60	6.80×10^{-4}	167
4	80	4.90×10^{-4}	125
5	100	4.00×10^{-4}	100

b.

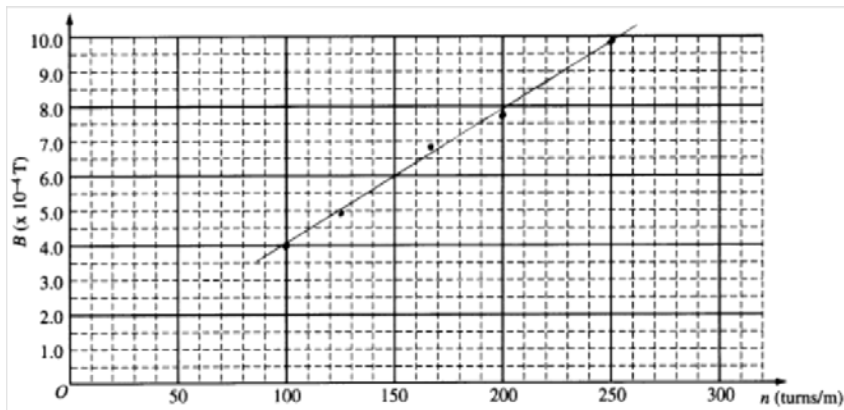

- $B = \mu_0 I n$ gives $\mu_0 I = \text{slope of line} = \Delta B / \Delta n = (9.5 - 4.5) \times 10^{-4} \text{ T} / (240 - 110) \text{ turns/m} = 5 \times 10^{-4} \text{ T} / 130 \text{ turns/m}$
 $\mu_{0\text{exp}} = (1/3 \text{ A})(5 \times 10^{-4} \text{ T} / 130 \text{ turns/m}) = 1.3 \times 10^{-6} \text{ (T-m)/A}$
- percent error = $100 \times (\mu_0 - \mu_{0\text{exp}}) / \mu_0 = -3.5\%$

2011E3

- a. For all three cases, the path of integration when applying Ampere's Law is a circle concentric with the cylinder and perpendicular to its axis, with a radius r in the range specified

$$\oint \vec{B} \cdot d\vec{l} = \mu_0 i_{enc}$$

i. $I_{enc} = 0$ so $B = 0$

ii. $J = I_0/(\pi b^2 - \pi a^2)$ so $I_{enc} = J \times (\text{area enclosed}) = I_0(r^2 - a^2)/(b^2 - a^2)$ giving $B = \mu_0 I_0(r^2 - a^2)/2\pi r(b^2 - a^2)$

iii. $B(2\pi 2b) = \mu_0 I_0$ gives $B = \mu_0 I_0/4\pi b$

- b.

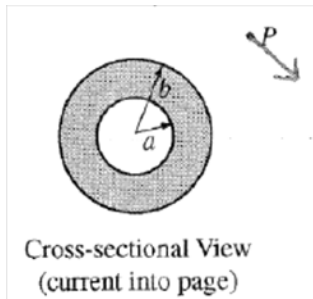

- c. There are no forces on the electron ($v = 0$)

- d. i.

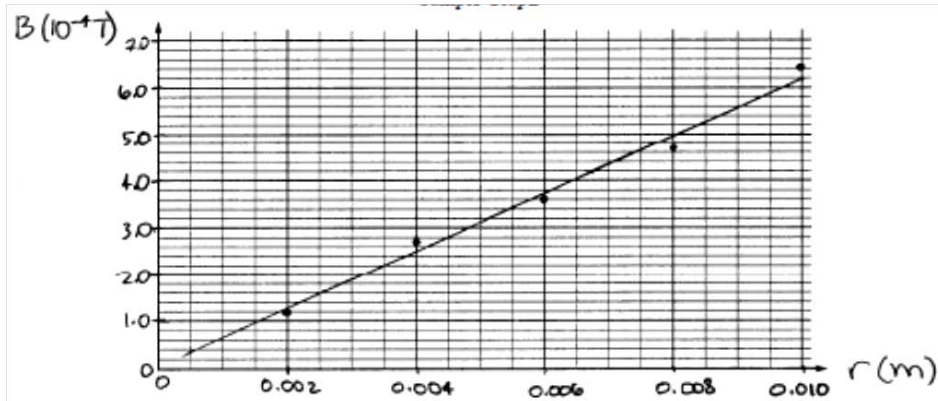

ii. slope = $\Delta B/\Delta r = (6.2 \times 10^{-4} \text{ T} - 2.8 \times 10^{-4} \text{ T})/(0.01 \text{ m} - 0.0045 \text{ m}) = 0.062 \text{ T/m}$

from $B = \mu_0 I_0 r/2\pi b^2$ we get the slope as $\mu_0 I_0/2\pi b^2 = 0.062 \text{ T/m}$ giving $\mu_0 = 1.56 \times 10^{-6} \text{ (T}\cdot\text{m)/A}$

SECTION C – Induction and Inductance

1975E3

- a. From RHR (Ampere) the field through the loop points into the page. This flux is increasing so the induced current will create a field out of the page to oppose this increase. From RHR (solenoid) this current will then be counterclockwise

b.

$$\phi = \int B \, dA = \int_a^b \frac{\mu_0 I}{2\pi r} l \, dr = \frac{\mu_0 I l}{2\pi} \int_a^b \frac{dr}{r} = \frac{\mu_0 I l}{2\pi} \ln\left(\frac{b}{a}\right)$$

$$|\mathcal{E}| = -\frac{d\phi}{dt} = -\frac{\mu_0 l}{2\pi} \ln\left(\frac{b}{a}\right) \frac{dI}{dt}$$

$$I = \frac{\mathcal{E}}{R} = -\frac{\mu_0 l}{2\pi R} \ln\left(\frac{b}{a}\right) \frac{dI}{dt}$$

1976E2

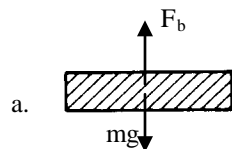

- b. Since the bar falls at constant velocity $F_{\text{net}} = 0$ so ... $mg = F_b$... $mg = BIL$... $I = mg / BL$
 c. Simply use the formula $\mathcal{E} = BLv_0$
 d. Using $V = IR$... $BLv_0 = (mg / BL)(R)$... $R = B^2 L^2 v_0 / mg$

1978E2

a.

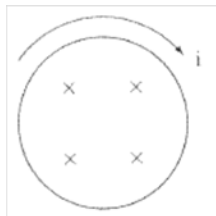

- b. From RHR (force) at every point the force is outward so the loop will tend to expand
 c. $\mathcal{E} = -d\phi/dt = -A \, dB/dt = \alpha AB_0 e^{-\alpha t}$
 $Q = \int I dt = \int (\mathcal{E}/R) dt = (\alpha AB_0/R) \int e^{-\alpha t} dt = AB_0/R$ (integrate from zero to infinity)
 d. $P = \int \mathcal{E}^2/R \, dt = (A^2 \alpha^2 B_0^2/R) \int e^{-2\alpha t} dt = A^2 B_0^2 \alpha / 2R$

1980E3

- a. The induced current will be clockwise. The field is increasing out of the page, the induced field must be into the page. By RHR (solenoid) the current will be clockwise.
- b. $\mathcal{E} = -d\phi/dt$ where $\phi = BA$ and $A = \pi r^2$ so $\mathcal{E} = -\pi r^2 C$ and $I = \mathcal{E}/R = -\pi r^2 C/R$
- c. The line integral of the electric field around a closed path is related to the changing flux by the expression

$$\oint E \cdot dl = -\frac{d\phi_B}{dt}$$
$$E2\pi r = \pi r^2 C \quad (r < a)$$
$$E = \frac{rC}{2}$$

- d. for $r > a$, $d\phi/dt = \pi a^2 C$ so $E = a^2 C/2r$
-

1981E3

- a. The field is decreasing out of the page, the induced field must be out of the page. By RHR (solenoid) the current will be counterclockwise.
- b. $\mathcal{E} = -d\phi/dt = -B dA/dt = -B d/dt (s \times (s - x)) = Bsv$ (or just use motional emf $\mathcal{E} = BLv = Bsv$)
- c. $I = \mathcal{E}/R = Bsv/R$
- d. $P = I^2 R = B^2 s^2 v^2 / R$
-

1982E2

- a.

$$\oint \vec{B} \cdot d\vec{l} = \mu_0 i_{enc}$$

Applied to a circular path of radius r gives $B(2\pi r) = \mu_0 I$ so that $B = \mu_0 I/2\pi r$

- b.

$$\phi = \int B dA = \int_a^{a+b} \frac{\mu_0 I}{2\pi r} l dr = \frac{\mu_0 I l}{2\pi} \int_a^{a+b} \frac{dr}{r} = \frac{\mu_0 I l}{2\pi} \ln\left(\frac{a+b}{a}\right)$$

- c. i. At $t = \pi/\omega$ the field produced from the current in the long wire is changing from out of the page to into the page so the induced current must cause a field to be produced out of the page, and by RHR (solenoid) the induced current must be counterclockwise.
- ii.

$$\phi = \frac{\mu_0 i_m l}{2\pi} \ln\left(\frac{a+b}{a}\right) \sin \omega t$$
$$-\frac{d\phi}{dt} = -\frac{\mu_0 l}{2\pi} \ln\frac{a+b}{b} \omega i_m \cos \omega t$$

At $t = \pi/\omega$, $\cos \omega t = -1$ so

$$\mathcal{E} = \frac{\mu_0 l \omega i_m}{2\pi} \ln\frac{a+b}{b}$$

1982E3

- a. After the switch has been closed for a long time, the current will have ceased changing, so the inductor voltage $V_L = L(dI/dt) = 0$. Therefore the inductor can be ignored in this part of the problem and $i = \mathcal{E}/R$
- b. After the switch has been opened, there are two resistors in series and $i_B = \mathcal{E}/2R$
- c.

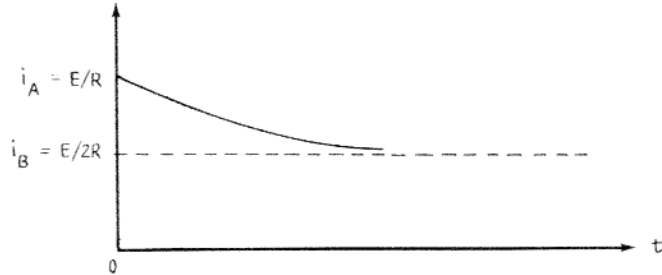

- d. $\mathcal{E} = V_R + V_L$ and $V_R = 2Ri$ and $V_L = L(di/dt)$
 $\mathcal{E} = 2Ri + L(di/dt)$
- e. The expression involves the exponential form $e^{-t/\tau}$ where $\tau = L/2R$ and must satisfy the boundary conditions $i(0) = \mathcal{E}/R$ and $i(\infty) = \mathcal{E}/2R$, by reasoning $i(t) = (\mathcal{E}/2R)(1 + e^{-2Rt/L})$

1984E3

- a. and c.

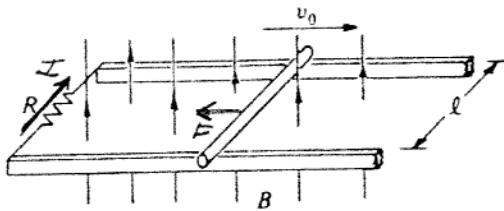

- b. Motional emf $\mathcal{E} = Blv_0$ so $I = \mathcal{E}/R = Blv_0/R$
- d. $F = ILB = B^2l^2v_0/R$
- e.

$$P = Fv = \frac{B^2l^2}{R} \left(v_0 e^{-\frac{B^2l^2t}{mR}} \right)^2 = \frac{B^2l^2}{R} v_0^2 e^{-\frac{2B^2l^2t}{mR}}$$

- f. $W = \int P dt$ and integrating the power expression from zero to infinity yields $\frac{1}{2} mv_0^2$

1985E3

- a. $|\mathcal{E}| = d\phi/dt = A dB/dt = \pi r^2 dB/dt = \pi(0.5 \text{ m})^2(60 \text{ T/s}) = 47 \text{ V}$
- b. E points to the left and $\mathcal{E} = Ed$ (for a uniform E field) which gives $E = \mathcal{E}/d = \mathcal{E}/2\pi r = 15 \text{ V/m}$
- c. $F = mv^2/r = qvB$ which gives $v = qrB/m = 8.8 \times 10^6 \text{ m/s}$
- d. $F = ma = qE$ where $E = 15 \text{ V/m}$ so $a = qE/m = 2.6 \times 10^{12} \text{ m/s}^2$

1986E2

- a. $V = IR$ and the total resistance from the two $40\ \Omega$ branches in parallel is $20\ \Omega$ so $R_{\text{total}} = 25\ \Omega$
 $I_T = V/R_{\text{total}} = 1\ \text{A}$, which will divide evenly between the two branches so $I = 0.5\ \text{A}$
- b. After the capacitor is charged, no current flows through the capacitor and the circuit behaves as it did without the capacitor so $I = 0.5\ \text{A}$
- c. Using Kirchoff's Loop Rule, $V_C = 10\ \text{V}$ and $Q = CV = 100\ \mu\text{C}$
- d. Now the circuit can be treated as a $10\ \Omega/30\ \Omega$ parallel combination in series with another $10\ \Omega/30\ \Omega$ parallel combination making $R_{\text{total}} = 5\ \Omega + 2 \times (10\ \Omega)(30\ \Omega)/(10\ \Omega + 30\ \Omega) = 20\ \Omega$ so $I_{\text{total}} = V/R_{\text{total}} = 1.25\ \text{A}$ and resistor R receives $\frac{3}{4} I_{\text{total}} = 0.9375\ \text{A}$
- e. Using Kirchoff's junction rule, $I_L = I_R - I_{30} = 0.625\ \text{A}$
-

1986E3

- a.
- $$\oint \vec{B} \cdot d\vec{l} = \mu_0 i_{\text{enc}}$$
- Where $i_{\text{enc}} = ct$ so $B = \mu_0 ct/2\pi r$
- b. The field from the long wire by RHR (ampere) is into the page and increasing, the induced field must be out of the page. By RHR (solenoid) the current will be counterclockwise
- c.
- $$\phi = \int B dA = \int_a^{a+b} \frac{\mu_0 I}{2\pi r} b dr = \frac{\mu_0 I b}{2\pi} \int_a^{a+b} \frac{dr}{r} = \frac{\mu_0 c t b}{2\pi} \ln\left(\frac{a+b}{a}\right)$$
- $$I = \frac{1}{R} \frac{d\phi}{dt} = \frac{\mu_0 c b}{2\pi R} \ln\left(\frac{a+b}{a}\right)$$
- d. The force is away from the wire as the repulsion of the (closer) oppositely directed current is greater than the attraction of the parallel (farther) current.
- e. $F_{\text{net}} = ILB_a - ILB_{a+b}$ gives
- $$F_{\text{net}} = \frac{\mu_0^2 c^2 b^2 t}{4\pi^2 R} \ln\left(\frac{a+b}{a}\right) \left(\frac{1}{a} - \frac{1}{a+b}\right)$$
-

1987E2

- a. $\phi = BA = 2e^{-4t} \times 0.09 = 0.18e^{-4t}$
- b. The field is decreasing out of the page, the induced field must be out of the page. By RHR (solenoid) the current will be counterclockwise
- c. $\mathcal{E} = -d\phi/dt = 0.72e^{-4t}$
 $I = \mathcal{E}/R = 0.12e^{-4t}$
- d. $W = \int P dt$ where $P = I^2 R$ and the integral is from zero to infinity
 $W = \int 0.864e^{-8t} dt = 0.108\ \text{J}$
-

1987E3

- Immediately after the switch is closed, there is no current in the inductor so $I = \mathcal{E}/R_{\text{total}} = 20 \text{ V}/200 \Omega = 0.2 \text{ A}$
 $V_{90} = IR = 18 \text{ V}$
- $\mathcal{E} = -LdI/dt$ and since the inductor is in parallel with the 90Ω resistor, $V_L = 18 \text{ V} = -LdI/dt$ giving $dI/dt = 36 \text{ A/s}$
- After a long time, the inductor shorts the 90Ω resistor so $I = \mathcal{E}/10\Omega = 2 \text{ A}$
- $U_L = \frac{1}{2} LI^2 = 1 \text{ J}$
- Immediately after the switch is opened, the current in the inductor is the same as it was just before the switch was opened and it is still in parallel with the 90Ω resistor so $V_{90} = V_L = IR = (2 \text{ A})(90 \Omega) = 180 \text{ V}$
-

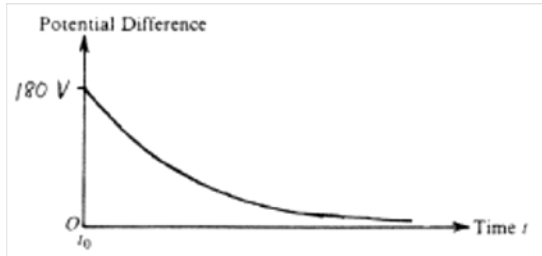

1988E3

- $$\oint \vec{B} \cdot d\vec{l} = \mu_0 i_{\text{enc}}$$

$$\int_a^b \vec{B} \cdot d\vec{l} + \int_b^c \vec{B} \cdot d\vec{l} + \int_c^d \vec{B} \cdot d\vec{l} + \int_d^a \vec{B} \cdot d\vec{l} = Bh + 0 + 0 + 0 = nhi$$

$$B = \mu_0 ni$$
- $\phi = B\pi r_2^2$ and $\mathcal{E} = d\phi/dt = \pi r_2^2 dB/dt = \pi r_2^2 \mu_0 ni/t$
- $\mathcal{E} = \int E dl = E 2\pi r_2$ giving $E = \mu_0 n i r_2 / 2t$
- $\mathcal{E} = d\phi/dt = \pi r_1^2 dB/dt = \pi r_1^2 \mu_0 ni/t$
- $\mathcal{E} = \int E dl = E 2\pi r_3$ giving $E = \mu_0 n i r_1^2 / 2t r_3$

1989E2

- Motional emf $\mathcal{E} = Bhv$ and $I = \mathcal{E}/R = Bhv/R$
 - $F_A = F_B = ILB = B^2 h^2 v/R$
- i. and ii.

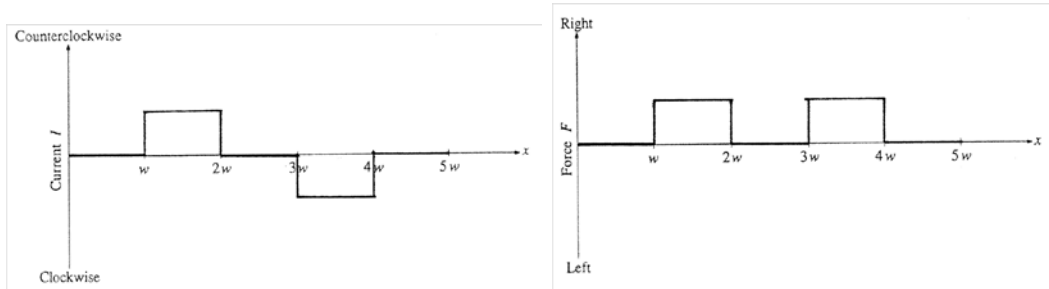

1990E3

- a. Since the loop is at rest, the magnetic force upwards must counteract the gravitational force down. Based on the RHR, the current must flow to the right in the top part of the loop to make a magnetic force upwards so the current flow is CW.
- b. $Mg = F_b \dots Mg = BIL \dots I = Mg / BL$
- c. $V = IR \quad V = MgR / BL$
- d. Simply use the formula $\mathcal{E} = BLv$
- e. The battery current flows to the right in the top bar as determined before. As the bar moves upwards, the induced emf would produce a current flowing to the left in the top bar based on Lenz law. These two effects oppose each other and the actual emf produced would be the difference between them.
 $V_{\text{net}} = (V_{\text{battery}} - \mathcal{E}_{\text{induced}}) = MgR / BL - BLv$. The current is then found with $V=IR$. $I = Mg/BL - BLv/R$
- f. Since the box moves at a constant speed, the new gravity force due to the new mass $(M - \Delta m)$ must equal the magnetic force in the top bar due to the current and field. The current flowing is that found in part e.
 $F_g = F_b \quad (M - \Delta m)g = BIL \quad Mg - \Delta mg = B(Mg/BL - BLv/R)L \quad Mg - \Delta mg = Mg - B^2L^2v / R$
 $\Delta m = B^2L^2v / Rg$

1991E2

- a. The inductor prevents any sudden changes in current so $I = 0$
- b. In steady state conditions, we ignore the inductor $I = \mathcal{E}/R_{\text{total}} = (50 \text{ V})/(150 \Omega + 100 \Omega) = 0.2 \text{ A}$
- c.

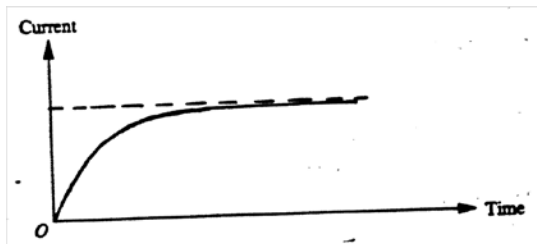

- d. $U_L = \frac{1}{2} LI^2 = 0.02 \text{ J}$
- e. Since the current will not change abruptly, it remains 0.2 A
- f. $V_L = IR = (0.2 \text{ A})(150 \Omega) = 30 \text{ V}$
- g. Dissipated in the resistor (becomes thermal energy)

1991E3

- a. Motional emf $\mathcal{E} = Blv_0$
- b. $I = \mathcal{E}/R$ and $F = IIB$ gives $F = B^2l^2v_0/R$
- c. $a = F/m = B^2l^2v_0/Rm$ and points opposite the direction of the velocity so

$$\frac{dv}{dt} = -v \frac{B^2l^2}{mR}$$

$$\int_{v_0}^v \frac{dv}{v} = - \int_0^t \frac{B^2l^2}{mR} dt$$

$$\ln v|_{v_0}^v = - \frac{B^2l^2}{mR} t$$

$$\ln \frac{v}{v_0} = -\frac{B^2 l^2}{mR} t$$

$$v = v_0 e^{-\frac{B^2 l^2 t}{mR}}$$

- d. From energy conservation, the resistor will eventually dissipate all the kinetic energy from the rod
 $E_{\text{diss}} = \frac{1}{2} m v_0^2$

1992E3

- a. From RHR (Ampere) the field is directed out of the page

- b. i.

$$\phi = \int B \, dA = \int_a^b \frac{\mu_0 I}{2\pi r} c \, dr = \frac{\mu_0 \alpha (1 - \beta t) c}{2\pi} \int_a^b \frac{dr}{r} = \frac{\mu_0 \alpha (1 - \beta t) c}{2\pi} \ln \left(\frac{b}{a} \right)$$

- ii.

$$|\mathcal{E}| = -\frac{d\phi}{dt} = -\frac{\mu_0 \alpha c}{2\pi} \ln \left(\frac{b}{a} \right) (-\beta) = \frac{\mu_0 \alpha c \beta}{2\pi} \ln \left(\frac{b}{a} \right)$$

- c.

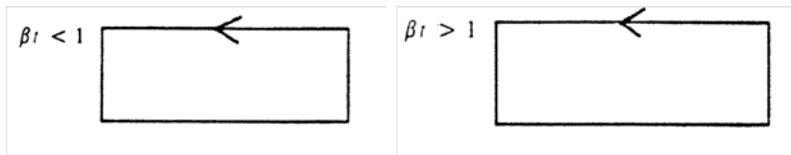

When $\beta t < 1$ the field is decreasing out of the page, the induced current will then create a field out of the page

When $\beta t > 1$ the field is increasing into the page, the induced current will then create a field out of the page

- d. The net force is down since the forces all pull outward on the loop and the bottom of the loop is closer to the wire

1993E2

- a. i. $\phi = BA = abB_0$

ii. $\mathcal{E} = -d\phi/dt = 0$

iii. With no \mathcal{E} and no current, there is no force

- b. When $\omega t = \pi/2$, $B = 0$, the field has been decreasing and is about to change direction, the induced current will create a field into the page to oppose this change and by RHR (solenoid) will be clockwise

- c. i. $\phi = abB_0 \cos \omega t$

$\mathcal{E} = -d\phi/dt = ab\omega B_0 \sin \omega t$ and $I = \mathcal{E}/R = (ab\omega B_0/R) \sin \omega t$

- ii.

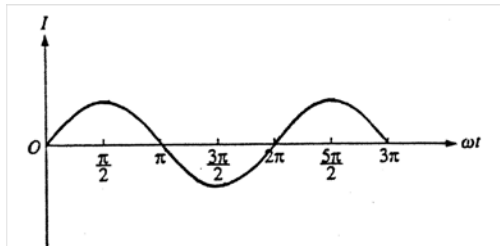

- d. The maximum is when $\sin \omega t = 1$ so $I_{\text{max}} = ab\omega B_0/R$

1994E2

- a. i. Consider the wire as a tube full of charges and focus on a single charge in the tube. That single charge is moving to the right in a B field pointing into the page. Using the RHR, that charge is pushed up to the satellite so the shuttle side is negative.
 ii. Induced emf is given by $\mathcal{E} = BLv = (3.3 \times 10^{-5})(20000\text{m})(7600) = 5016 \text{ V}$
- b. $V = IR \quad 5016 = I(10000) \quad I = 0.5016 \text{ A}$
- c. i. $F_b = BIL = (3.3 \times 10^{-5})(0.5016)(20000) \quad F_b = 0.331 \text{ N}$
 ii. The current flows up, away from the shuttle as indicated. Using the RHR for the given I and B gives the force direction on the wire pointing left which is opposite of the shuttles velocity.
- d. $\Delta U = Pt$ where $P = I^2R$ so $\Delta U = I^2Rt = (0.5016 \text{ A})^2(10,000 \Omega)(7 \text{ d})(24 \text{ h/d})(60 \text{ min/h})(60 \text{ s/min}) = 1.52 \times 10^9 \text{ J}$
- e. The direction of the magnetic force would be reversed, this would do work on the shuttle, and the resulting gain in energy would increase the radius of the orbit

1995E3

- a. Motional emf $\mathcal{E} = Bhv_0$
 b. $I = \mathcal{E}/R = BHv_0/R$
 c. The field is increasing out of the page, the induced field must be into the page. By RHR (solenoid) the current will be clockwise
 d. $a = F/m = IHB/m = B^2H^2v/Rm$ and points opposite the direction of the velocity so

$$\frac{dv}{dt} = -v \frac{B^2H^2}{mR}$$

$$\int_{v_0}^v \frac{dv}{v} = - \int_0^t \frac{B^2H^2}{mR} dt$$

$$\ln v|_{v_0}^v = - \frac{B^2H^2}{mR} t$$

$$\ln \frac{v}{v_0} = - \frac{B^2H^2}{mR} t$$

$$v = v_0 e^{-\frac{B^2H^2t}{mR}}$$

e.

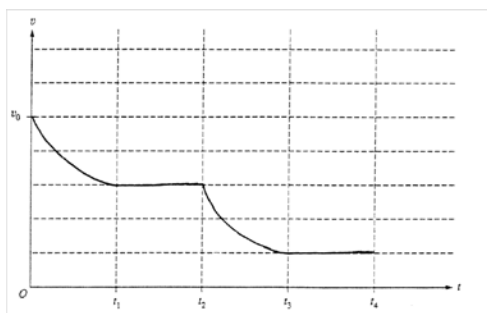

1996E3

- a. $\phi = B\pi r^2$ and $\mathcal{E} = d\phi/dt = \pi r^2 dB/dt$
 $\mathcal{E} = \int E dl = E 2\pi r$ giving $E = (r/2)dB/dt$

b.

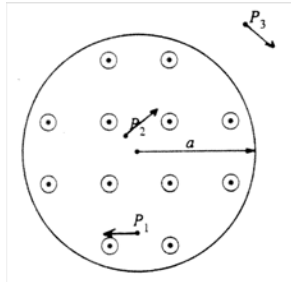

- c. The calculation is the same as part (a) except the contributing flux exists only inside radius a
 $E(2\pi r) = \pi a^2 dB/dt$
 $E = (a^2/2r) dB/dt$

d.

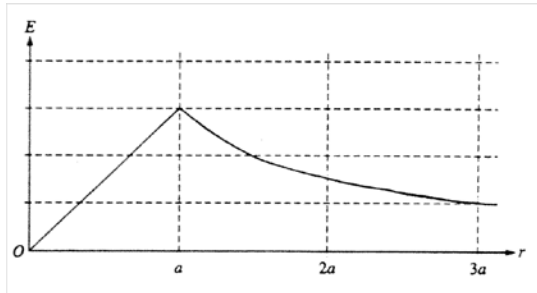

1997E3

a.

$$\oint \vec{B} \cdot d\vec{l} = \mu_0 i_{enc}$$

Applied to a circular path of radius r gives $B(2\pi r) = \mu_0 I$ so that $B = \mu_0 I / 2\pi r$

- b. By RHR (Ampere) the field points out of the page, in the $+z$ direction

c.

$$\begin{aligned} \phi &= \int B dA = \int_s^{s+w} \frac{\mu_0 I}{2\pi r} l dr = \frac{\mu_0 I l}{2\pi} \int_s^{s+w} \frac{dr}{r} = \frac{\mu_0 I l}{2\pi} \ln r \Big|_s^{s+w} = \frac{\mu_0 I l}{2\pi} (\ln(s+w) - \ln(s)) \\ &= \frac{\mu_0 I l}{2\pi} \ln\left(\frac{s+w}{s}\right) \end{aligned}$$

- d. As the loop moves away, the field decreases (out of the page) so the induced current will create a field out of the page to oppose this change and by RHR (solenoid) the current is counterclockwise

e. $-y$, the closer section of the loop experiences the larger force toward the wire

f.

$$|\mathcal{E}| = -\frac{d\phi}{dt} = -\frac{d}{dt} \frac{\mu_0 I l}{2\pi} (\ln(s+w) - \ln(s)) = -\frac{\mu_0 I l}{2\pi} \left(\frac{1}{s+w} - \frac{1}{s} \right) \frac{ds}{dt} = \frac{\mu_0 I l v}{2\pi R} \left(\frac{w}{s(s+w)} \right)$$

1998E2

a.

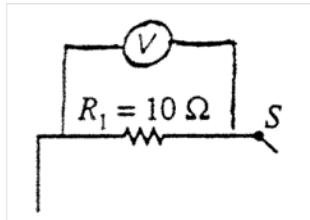

- b. The capacitor is ignored: $I = \mathcal{E}/(R_1 + R_2) = 20 \text{ V}/30 \Omega = 0.67 \text{ A}$
 $V = IR = 6.67 \text{ V}$
- c. i. $V = 0$ (the capacitor is charged, current is zero).
ii. $Q = CV = (15 \mu\text{F})(20 \text{ V}) = 300 \mu\text{C}$
- d. $V = 0$
- e. i. The inductor is ignored: $I = \mathcal{E}/(R_1 + R_2) = 20 \text{ V}/30 \Omega = 0.67 \text{ A}$
ii. $U_L = \frac{1}{2} LI^2 = 0.444 \text{ J}$
- f. $\mathcal{E} - I(R_1 + R_2) - L(dI/dt) = 0$
-

1998E3

- a. At constant speed $F_{\text{net}} = 0$ $F_b = F_{\text{gx}}$ $BIL = mg \sin \theta$ $I = mg \sin \theta / BL$
- b. Using the induced emf and equating to $V=IR$ we have $IR = BLv$, sub in I from above
 $(mg \sin \theta / BL)R = BLv$... solve for $v = mgR \sin \theta / B^2 L^2$
- c. Rate of energy is power. $P = I^2 R$ $P = (mg \sin \theta / BL)^2 R$
- d. Since the resistor is placed between the rails at the bottom, it is now in parallel with the top resistor because the current has two pathways to choose, the top loop with resistor R or the new bottom loop with the new resistor R . This effectively decreases the total resistance of the circuit. Based on the formula found in part b, lower resistance equates to less velocity.
- e. Yes, the speed will decrease. With two resistors in parallel, the effective resistance decreases and v is proportional to R
-

1999E2

- a. $|\mathcal{E}| = d\phi/dt = A dB/dt = \pi r^2 dB/dt = \pi(0.6 \text{ m})^2(0.40 \text{ T/s}) = 0.45 \text{ V}$
- b. $I = \mathcal{E}/R = 0.09 \text{ A}$
- c. $W = Pt = I^2 R t = 0.61 \text{ J}$
- d. The brightness would be less, since the effective area for the magnetic flux is less, the induced current will be less
-

2000E1

a. A, C, B

Bulb A receives the total current (it is in the main branch), then the current divides where bulb C receives more current while having the same voltage as bulb B

b. i. Immediately after the switch is closed, there is no current in the inductor so $I_C = 0$ and the circuit consists of resistors A and B only and $I_A = I_B = E/R_{\text{total}} = (42 \text{ V})/(10 \Omega + 12 \Omega) = 1.91 \text{ A}$

ii. A long time later, the potential difference across the inductor is zero so the circuit behaves as it did in part

(a). The total resistance is $R_{\text{total}} = R_A + (R_B)(R_C)/(R_B + R_C) = 14 \Omega$ so $I_{\text{total}} = I_A = (42 \text{ V})/(14 \Omega) = 3 \text{ A}$

$I_B = 1/3 I_{\text{total}} = 1 \text{ A}$ and $I_C = 2/3 I_{\text{total}} = 2 \text{ A}$

c.

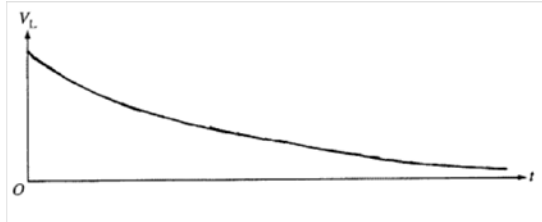

d.

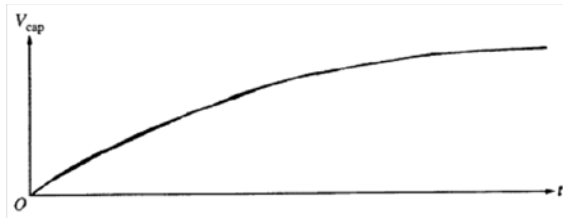

2002E3

- a. $\phi = BA \cos \theta$ where $A = \pi r^2$ and $\theta = 60^\circ$
 $\phi = \pi(0.10 \text{ m})^2(4(1 - 0.2t)) \cos 60^\circ = (0.063)(1 - 0.2t) \text{ Wb}$
- b.

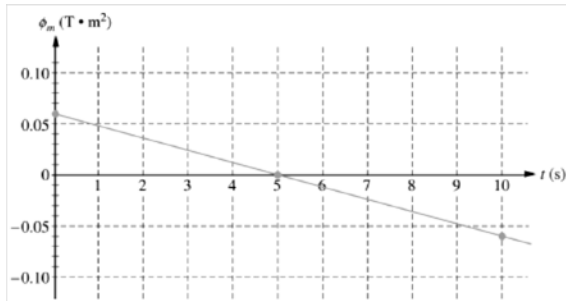

- c. $\mathcal{E} = -d\phi/dt = -(0.063)(-0.2) = 0.013 \text{ V}$
- d. i. $I = \mathcal{E}/R = 2.6 \times 10^{-4} \text{ A}$
- ii.

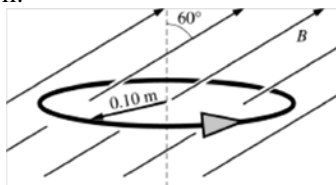

- e. $W = Pt = I\mathcal{E}t = 1.3 \times 10^{-5} \text{ J}$

2003E3

- a.

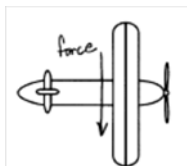

- b. Equilibrium is reached when the electric force due to the separation of charge in the antenna balances the magnetic force on an electron, that is $qE = qvB \sin \theta$ giving $E = vB \sin \theta = 0.0037 \text{ V/m}$
- c. $V = Ed = 0.0553 \text{ V}$
- d.

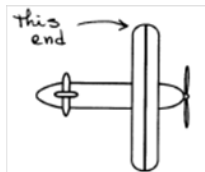

- e. i. There must be a change in the magnetic flux through the closed loop. To do this the plane could execute a forward dive increasing its angle with respect to the horizontal
- ii.

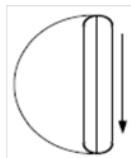

2004E3

a.

$$\phi = \int B \, dA = \int_l^{4l} \frac{\mu_0 I}{2\pi r} 4l \, dr = \frac{2\mu_0 I l}{\pi} \int_l^{4l} \frac{dr}{r} = \frac{2\mu_0 I l}{\pi} \ln\left(\frac{4l}{l}\right) = \frac{2\mu_0 I l}{\pi} \ln 4$$

b. The field is decreasing out of the page, the induced field must be out of the page. By RHR (solenoid) the current will be counterclockwise

c. $\phi = 2l\mu_0 I_0(\ln 4)e^{-kt}/\pi$ and $\mathcal{E} = -d\phi/dt$ and $I_{\text{loop}} = \mathcal{E}/R$ which gives $I_{\text{loop}} = 2lk\mu_0 I_0(\ln 4)e^{-kt}/\pi R$

d. $P = I^2 R$ and $W = \int P \, dt$ (from zero to infinity) which gives $W = (2l\mu_0 I_0(\ln 4)/\pi)^2 (k/2R)$

2005E2

a. The current through the inductor is zero immediately after the switch is closed. So $R_{\text{total}} = R_1 + R_2$ and $I = \mathcal{E}/R_{\text{total}} = \mathcal{E}/(R_1 + R_2)$

b. Since the inductor is in parallel with R_2 its voltage is identical so $V_L = V_{R_2} = IR_2 = LdI/dt$
 $dI/dt = IR_2/L = \mathcal{E}R_2/(R_1 + R_2)L$

c. After a long time the inductor shorts R_2 so $R_{\text{total}} = R_1$ and $I = \mathcal{E}/R_1$

d.

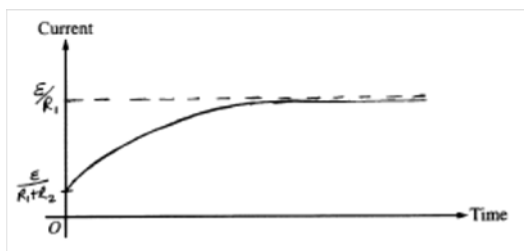

2006E3

a.

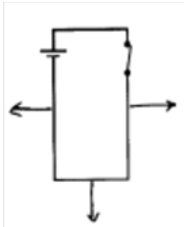

b. $F_S = F_B$
 $kx = ILB$ so $B_0 = kx/Iw$

c. i.

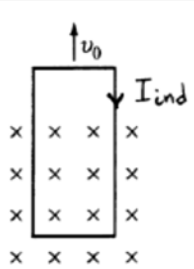

ii. Motional emf $\mathcal{E} = B_0 w v_0$ and $I = \mathcal{E}/R = B_0 w v_0/R$

d. $P = I^2 R = B_0^2 w^2 v_0^2 / R$

e. Increases. F is proportional to B as is the current.

2007E3

a. The flux is increasing into the page, the induced field must be out of the page. By RHR (solenoid) the current will be counterclockwise

b. Motional emf $\mathcal{E} = Blv$ and the resistance depends on the length $R = \lambda d = \lambda(L + 2x)$ where $x = vt$
 $I = \mathcal{E}/R = BLv/\lambda(L + 2vt)$

c. $F = ILB = B^2 L^2 v / \lambda(L + 2vt)$

d.

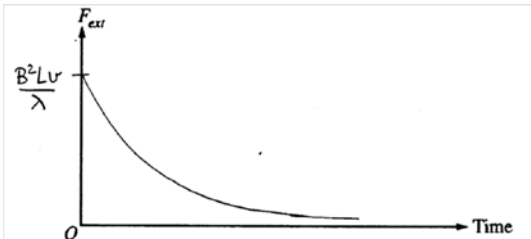

e. Decreases. If $F_{ext} = 0$, then the only force is F_B which opposes the motion of the rod.

2008E2

- a. i. For the parallel branch $1/R = 1/(100 \Omega + 50 \Omega) + 1/300 \Omega$ which gives $R = 100 \Omega$ and with the main branch resistor $R_{\text{total}} = 300 \Omega$ and $I_{\text{total}} = \mathcal{E}/R_{\text{total}} = 5 \text{ A}$
 $V_1 = I_{\text{total}}R_1 = 1000 \text{ V}$ and $V_2 = \mathcal{E} - V_1 = 500 \text{ V}$
 ii. The current in branch 3 is zero at $t = 0$ so $R_{\text{total}} = 500 \Omega$ and $I_{\text{total}} = 3 \text{ A}$ so $V_2 = IR_2 = 900 \text{ V}$
 iii. The capacitor is ignored at $t = 0$ so $R_{\text{total}} = 200 \Omega + (1/100 \Omega + 1/300 \Omega)^{-1} = 275 \Omega$ and $I_{\text{total}} = 5.45 \text{ A}$
 $V_2 = I_{\text{total}}R_{\text{parallel branches}} = (5.45 \text{ A})(75 \Omega) = 410 \text{ V}$
- b.

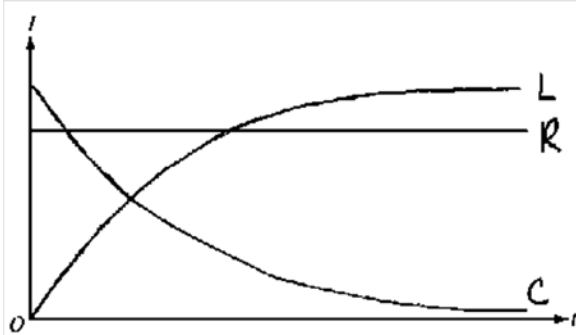

The current is constant with the resistor placed between points *A* and *B*. The resistance of that branch is more than when the capacitor and inductor are placed there, so the current will be less. The inductor initially opposes the flow of current, so the initial current in that branch is zero. Eventually, the inductor acts like a wire and does not impede the flow of charge, as the rate of change of current decreases to zero. Initially, the capacitor is uncharged and current is a maximum in the branch containing R_3 . As the capacitor charges the current in that branch decreases to zero.

2008E3

- a. i. B points toward the top of the page
ii.

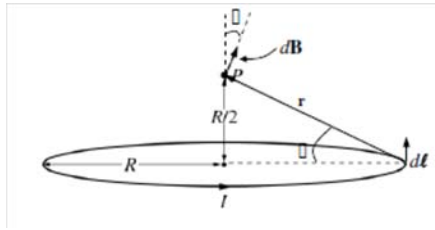

The empty rectangle in the diagram represents the angle α

$$dB = \frac{\mu_0}{4\pi} \frac{I dl \times r}{r^3} = \frac{\mu_0}{4\pi} \frac{I dl r \sin \theta}{r^3} = \frac{\mu_0}{4\pi} \frac{I dl}{r^2}$$

$$B = \int dB_{vertical} = \int dB \cos \alpha = \int \frac{R}{r} dB$$

$$r = \sqrt{R^2 + \frac{R^2}{4}} = \frac{\sqrt{5}}{2} R$$

$$B = \int \frac{R}{r} dB = \frac{\mu_0 IR}{4\pi \left(\frac{\sqrt{5}}{2} R\right)^3} \int dl = \frac{\mu_0 IR}{4\pi \left(\frac{\sqrt{5}}{2} R\right)^3} 2\pi R = \frac{4\mu_0 I}{5\sqrt{5} R}$$

- b. B_{net} is the vector sum from the two loops, which produce identical fields in the same direction so $B_{net} = 2B_1$

$$B_{net} = \frac{8\mu_0 I}{5\sqrt{5} R}$$

- c. $\phi = BA = B_{net} s^2$
d. $\phi = B_{net} s^2 \cos \theta = B_{net} s^2 \cos \omega t$ and $\mathcal{E} = -d\phi/dt = -B_{net} s^2 \omega \sin \omega t$

2009E3

- a. $|\mathcal{E}| = d\phi/dt = A(dB/dt) = L^2 a$
b. i. The resistors are in series so $R_t = 2R_0$ and $I = \mathcal{E}/R = aL^2/2R_0$
ii.

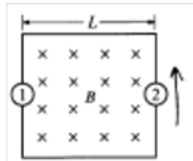

- c. $P = I^2 R = a^2 L^4 / 4R_0$
d. Bulb 1 is brighter. The emf is the same as in the original circuit (since there is no flux through the added loop). Adding a bulb in parallel with bulb 2 decreases the overall resistance of the circuit. Decreasing the overall resistance increases the overall current, which is equal to the current in bulb 1
e. Bulb 1 is the same brightness. Since each loop has half the area, each has half the original emf. But each also has half the resistance. This means the current and thus the power in bulb 1 is the same. The two loops are essentially identical. Separately, the flux through each loop would create an emf that is counterclockwise. Since these emfs are in opposite directions in the central wire, the net effect is that there is no emf in that wire. Therefore the situation is equivalent to the original one.

2010E3

- a. The flux is decreasing out of the page, the induced field must be out of the page. By RHR (solenoid) the current will be counterclockwise
- b. Remains the same. The field and the flux both vary linearly with time. The emf, which is the time derivative of the flux, must then be constant. Since the power output of the lightbulb depends only on the emf and resistance (which are both constant), the power must be constant.

c.

$$\oint \vec{B} \cdot d\vec{l} = \mu_0 i_{enc}$$

Applied to a circular path of radius r gives $B(2\pi r) = \mu_0 I_0$ so that $B = \mu_0 I_0 / 2\pi r$

d.

$$\phi = \int B dA = \int_d^{a+d} \frac{\mu_0 I}{2\pi r} b dr = \frac{\mu_0 I b}{2\pi} \int_d^{a+d} \frac{dr}{r} = \frac{\mu_0 (I_0 - Kt) b}{2\pi} \ln\left(\frac{a+d}{d}\right)$$

- e. $\mathcal{E} = -d\phi/dt = -(\mu_0 b/2\pi) \ln[(a+d)/d](-K)$
 $P = \mathcal{E}^2/R = (1/R)\{(\mu_0 bK/2\pi) \ln[(a+d)/d]\}^2$

2011E2

- a. i. $Q = CV = (25 \times 10^{-3} \text{ F})(9 \text{ V}) = 0.23 \text{ C}$
 ii.

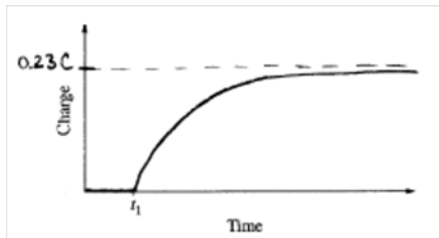

iii.

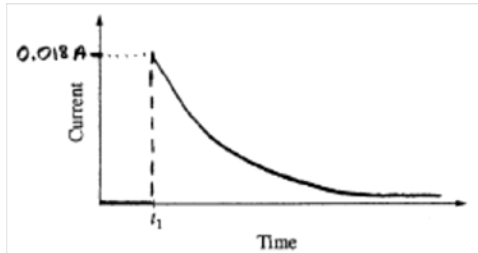

- b. i. $U_C = \frac{1}{2} Q^2/C = 0.22 \text{ J}$
 ii. The maximum current is when there is no charge in the capacitor and all the energy is stored in the inductor $0.22 \text{ J} = U_L = \frac{1}{2} LI^2$ which gives $I_{max} = 0.3 \text{ A}$
 iii. From the loop rule: $LdI/dt + Q/C = 0$ so $dI/dt = -Q/CL = -(50 \times 10^{-3} \text{ C})/(25 \times 10^{-3} \text{ F})(5.0 \text{ H}) = -0.4 \text{ A/s}$

